

ABCDEFGHIJKLMN OPQRSTUVWXYZ 0123456789

bcdefghijklmnopqrstuvwxyz

ABCDEFGHIJKLMN OPQRSTUVWXYZ 0123456789

bcdefghijklmnopqrstuvwxyz

TYPES OF LINES :->

VISIBLE OUTLINE

HIDDEN LINE

CENTRAL LINE

PROJECTION LINE

CONSTRUCTION LINE

CUTTING LINE

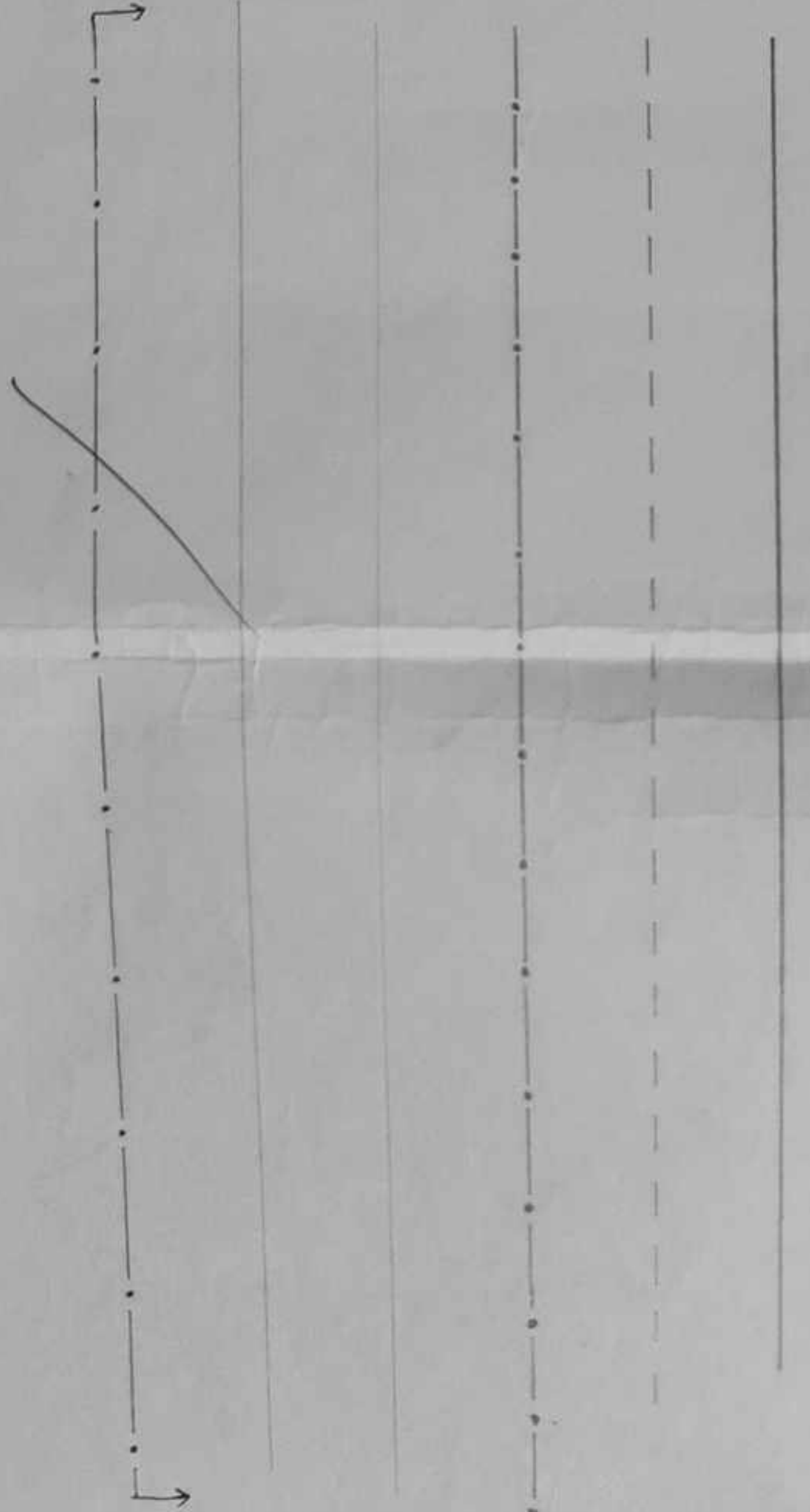

Fig 1

Submitted by :->

Name :-> Krishna Murari Aryal

Roll no :-> 009

Faculty :-> OCT I/T

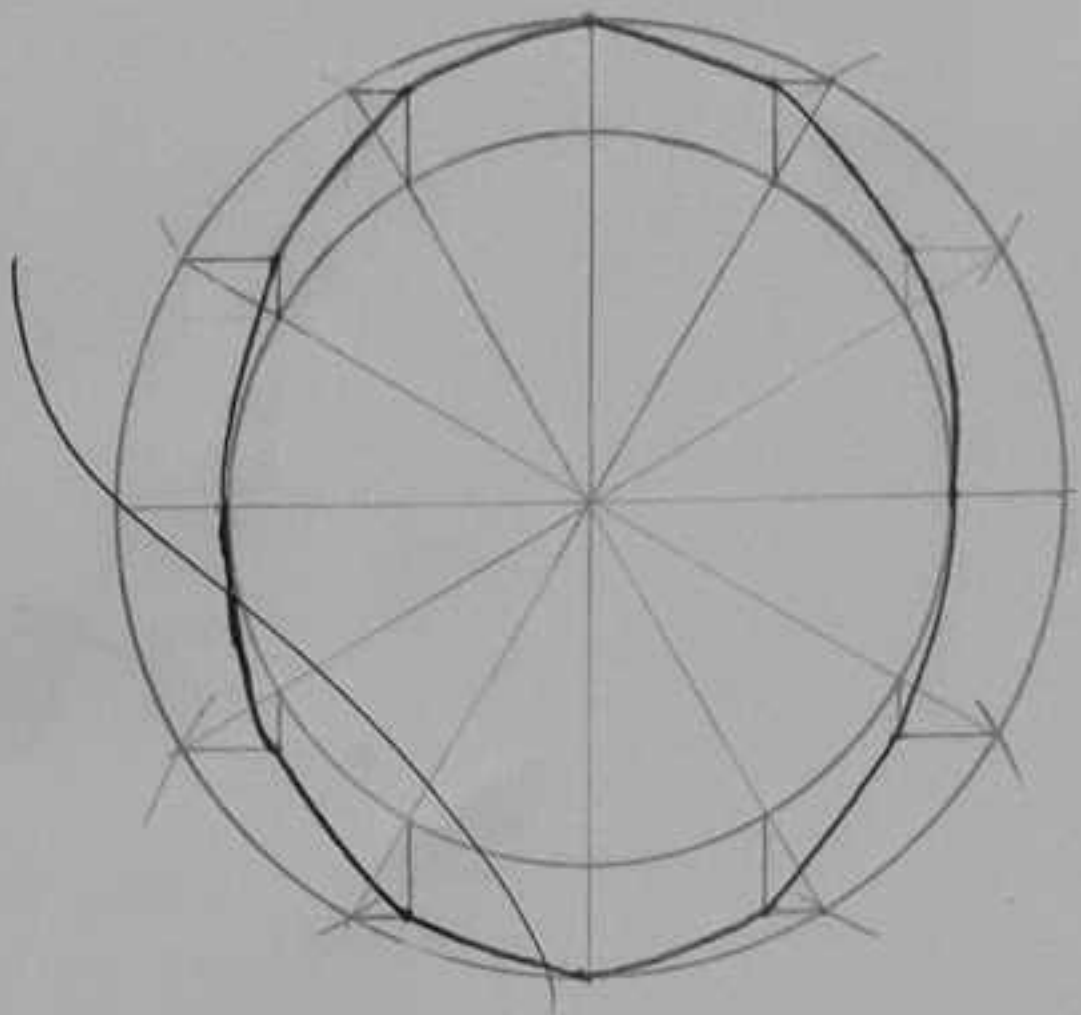

Fig 9.a

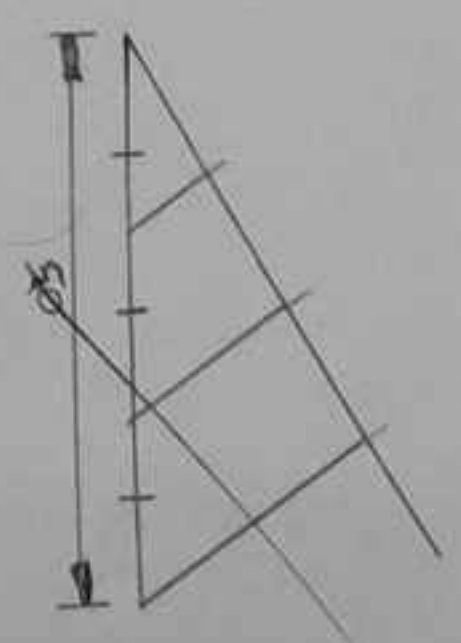

Fig 1.a

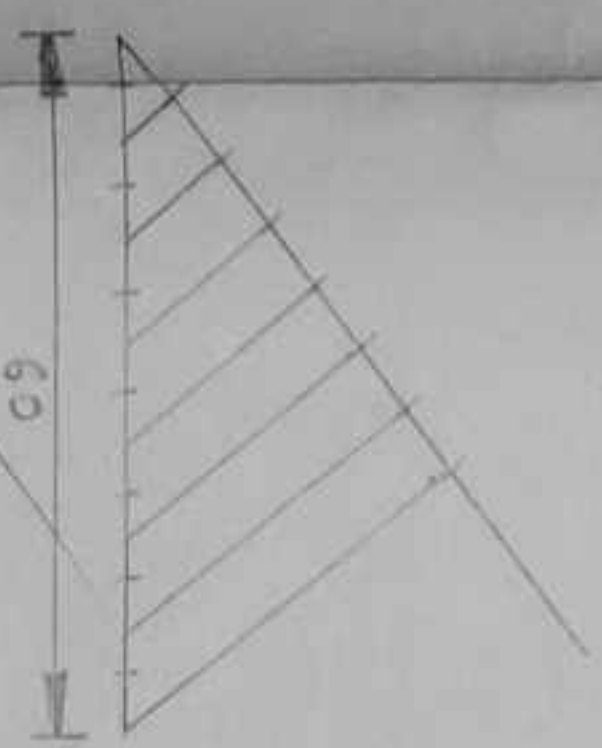

Fig 1.c

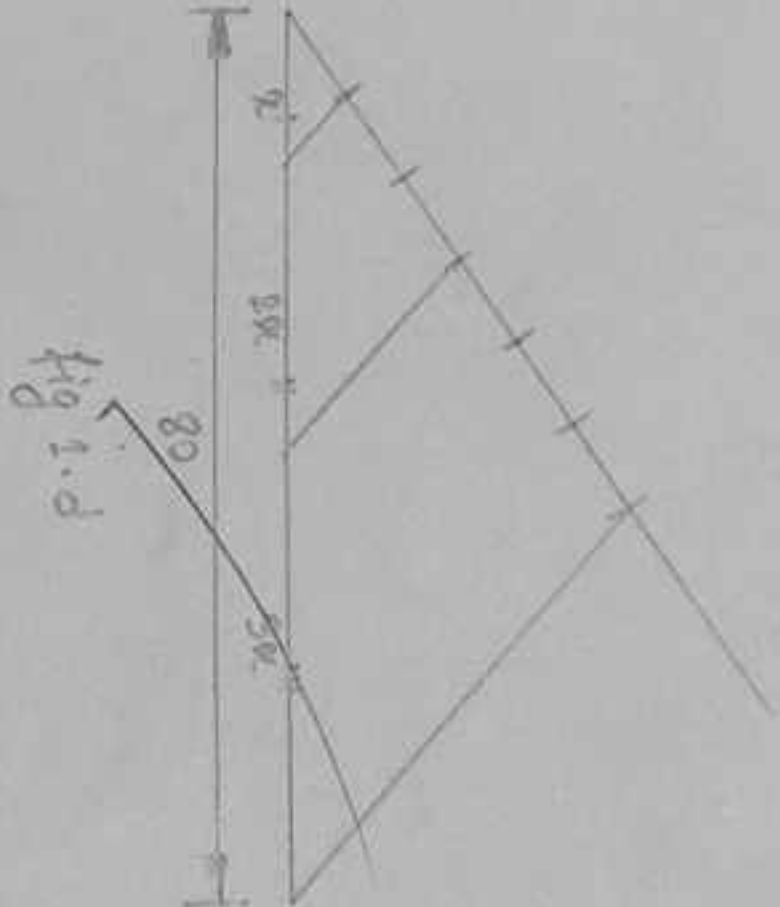

Fig 1.d

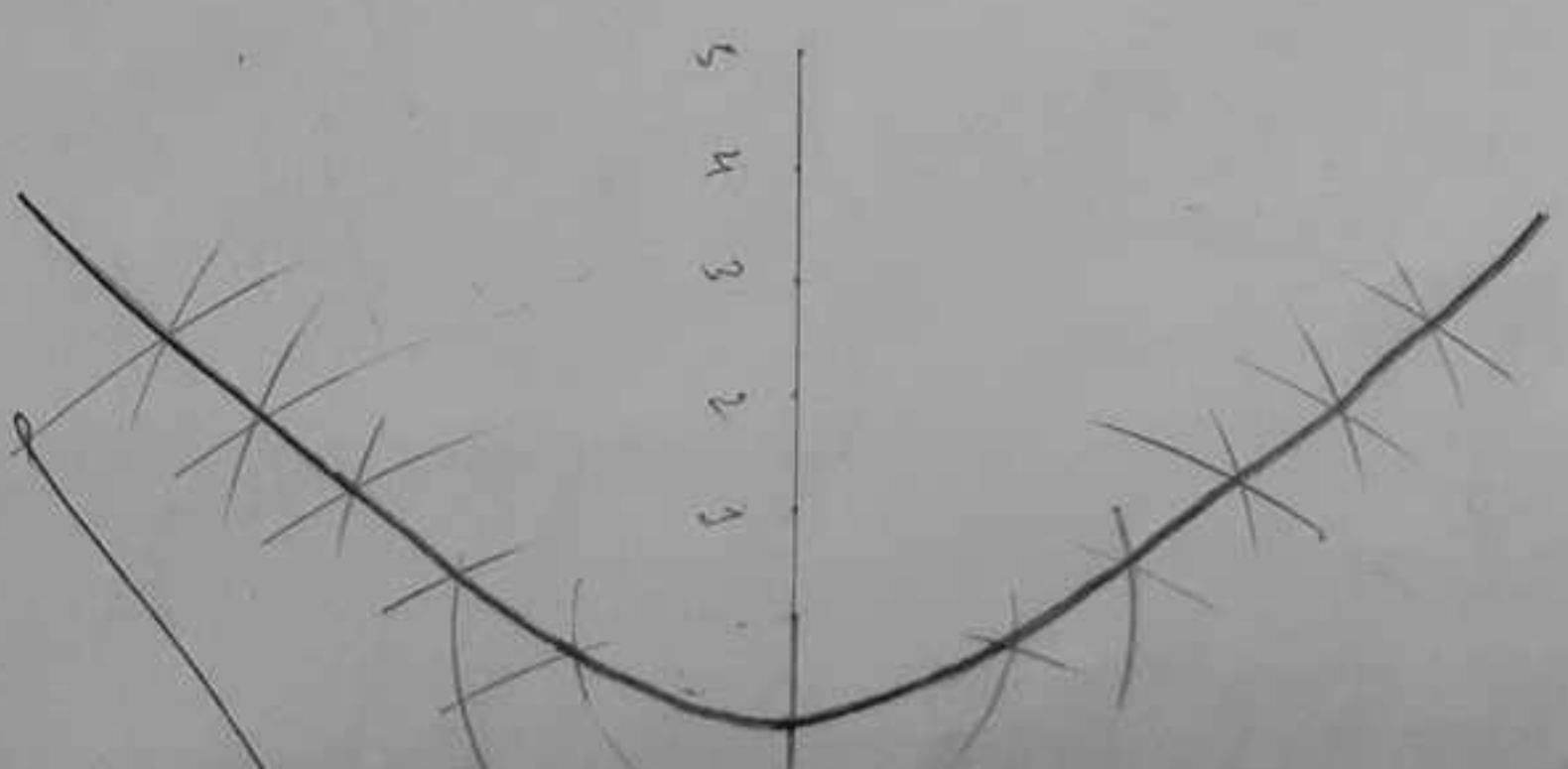

Fig 10

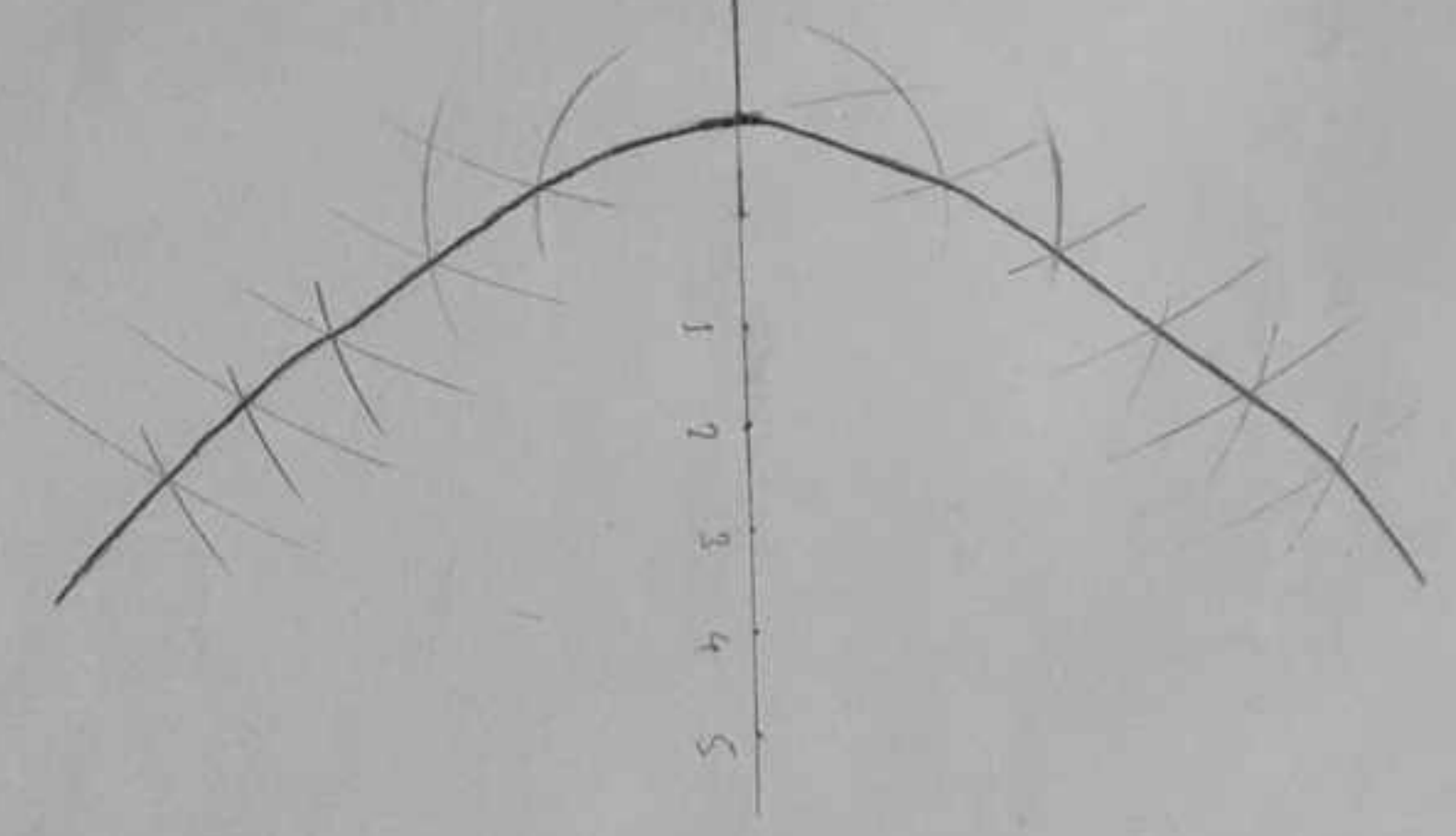

Fig 2.a

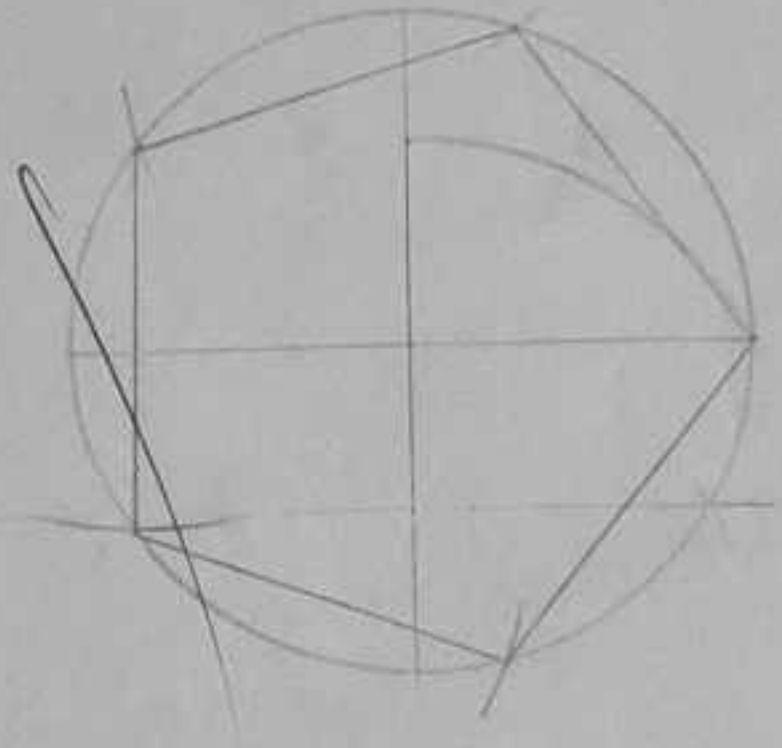

Fig 2.b

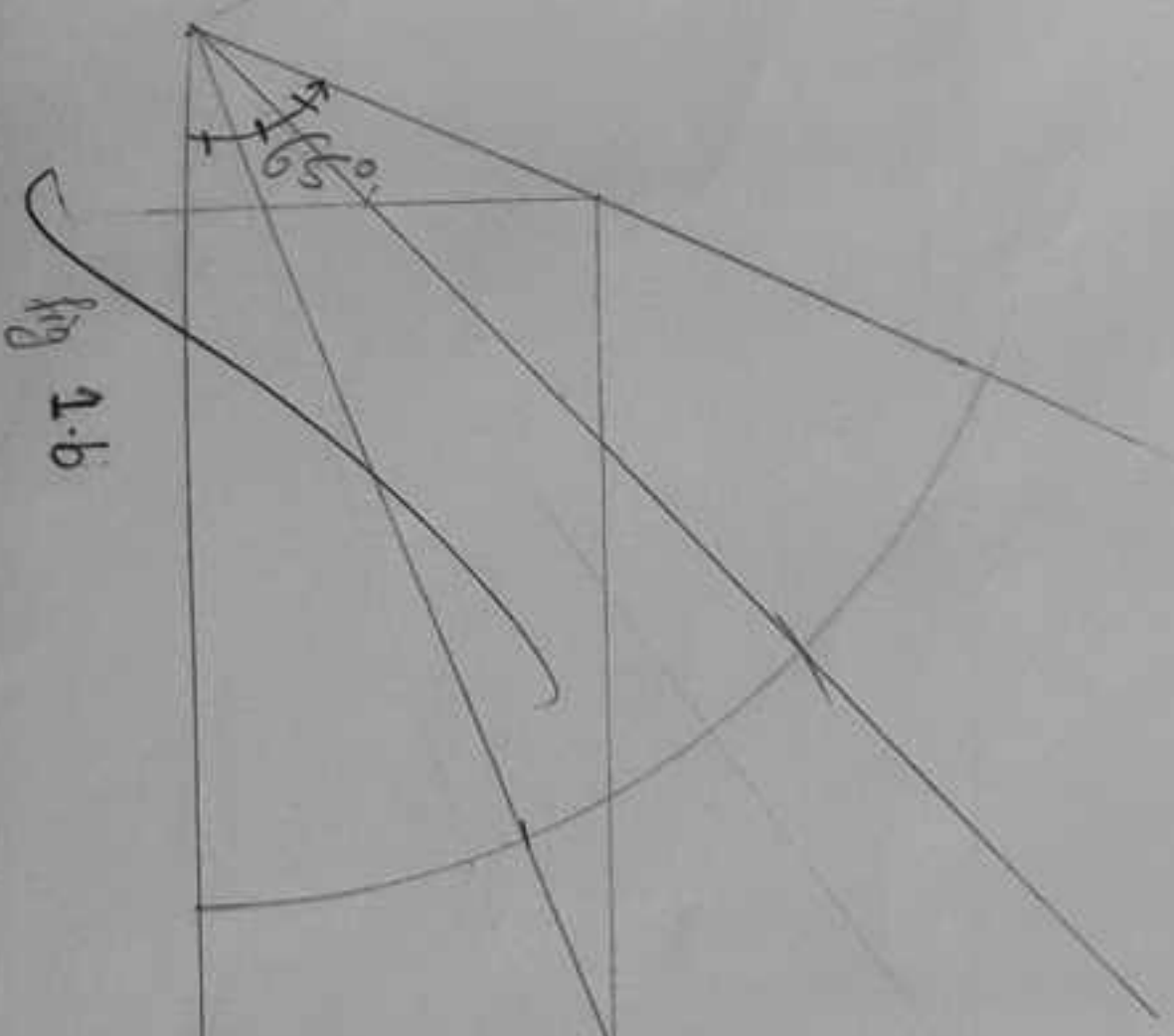
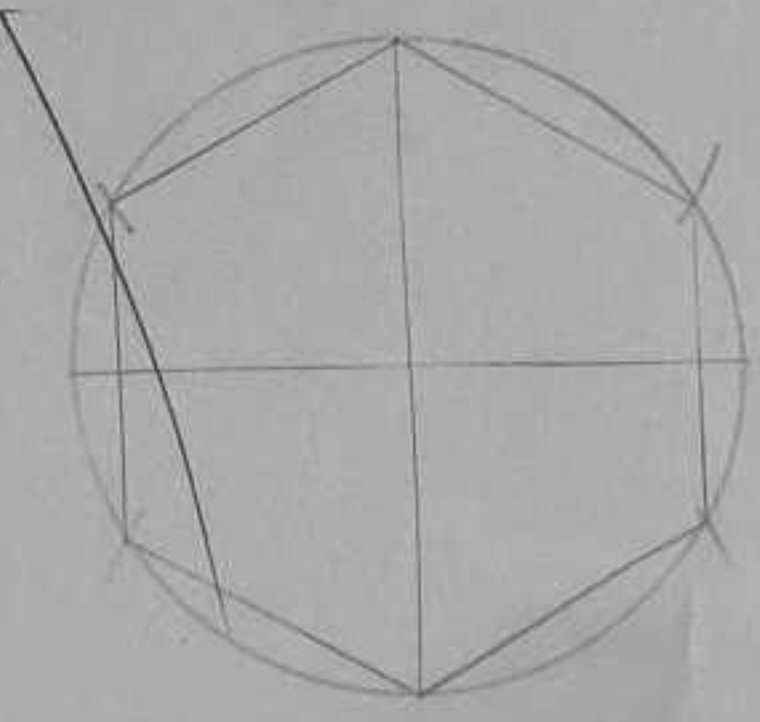

Fig 1.b

Sc

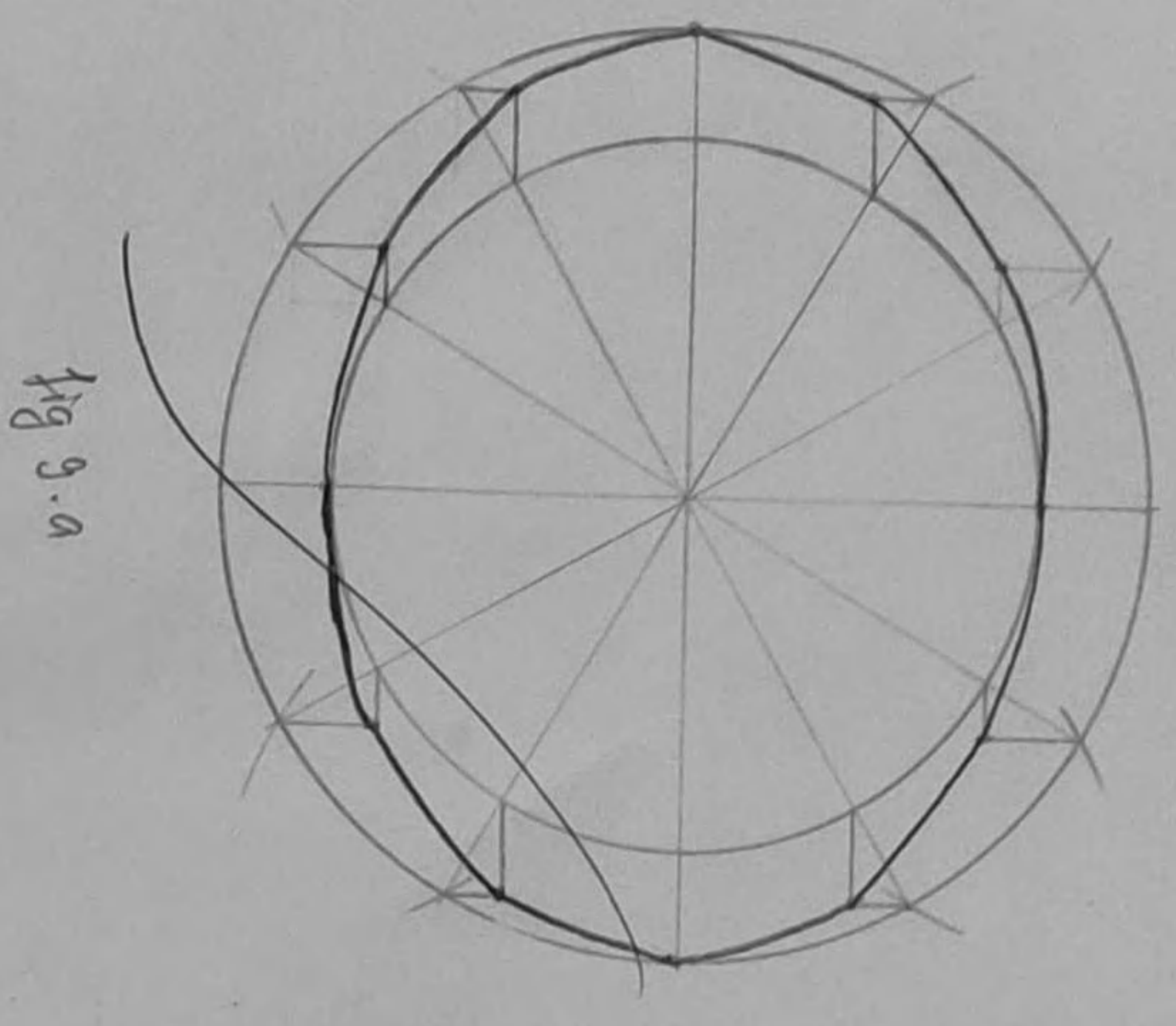

Fig 1.0

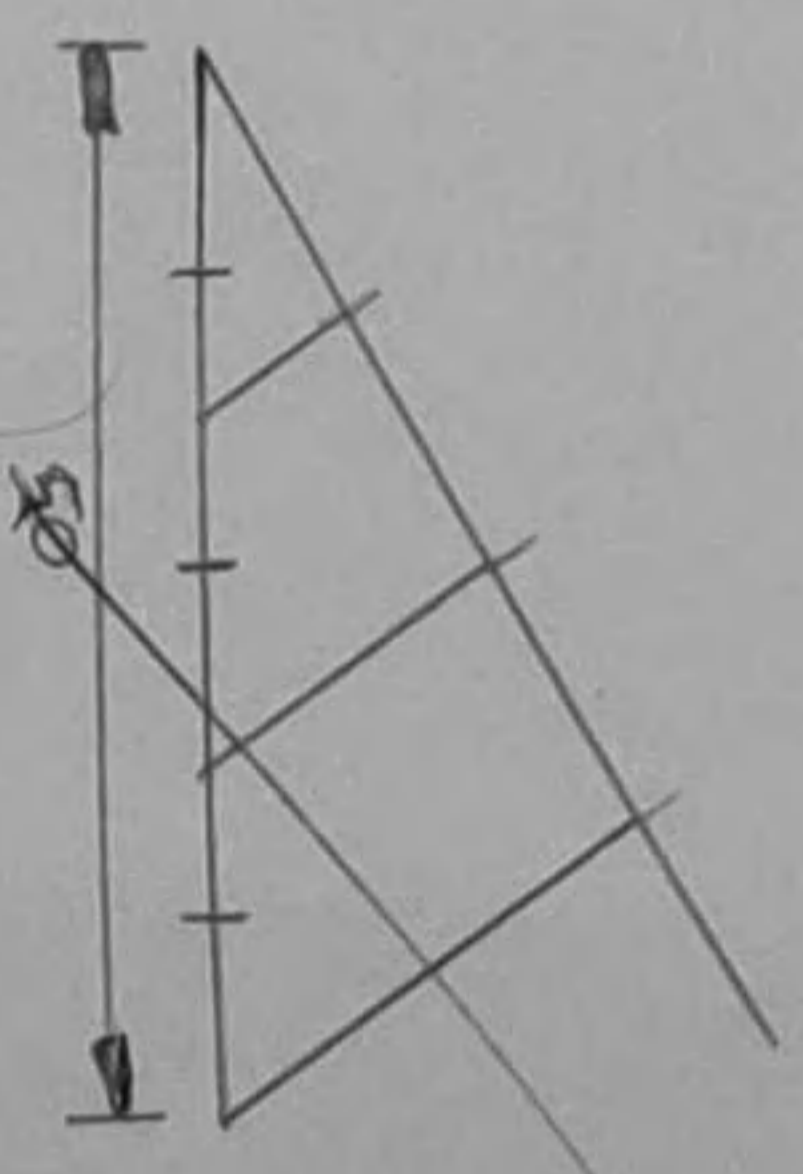

Fig 1.a

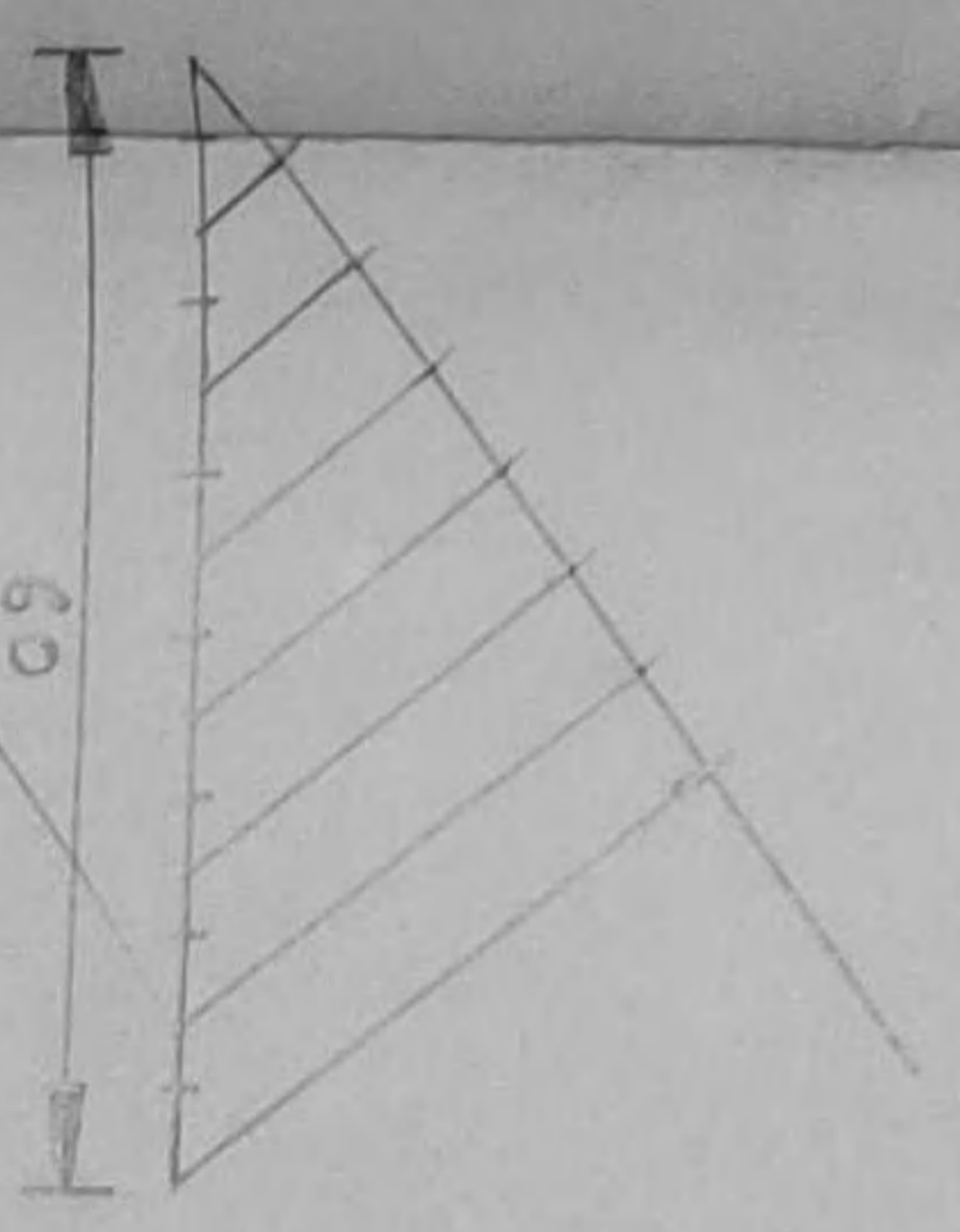

Fig 1.c



Fig 1.d



5 4 3 2 1

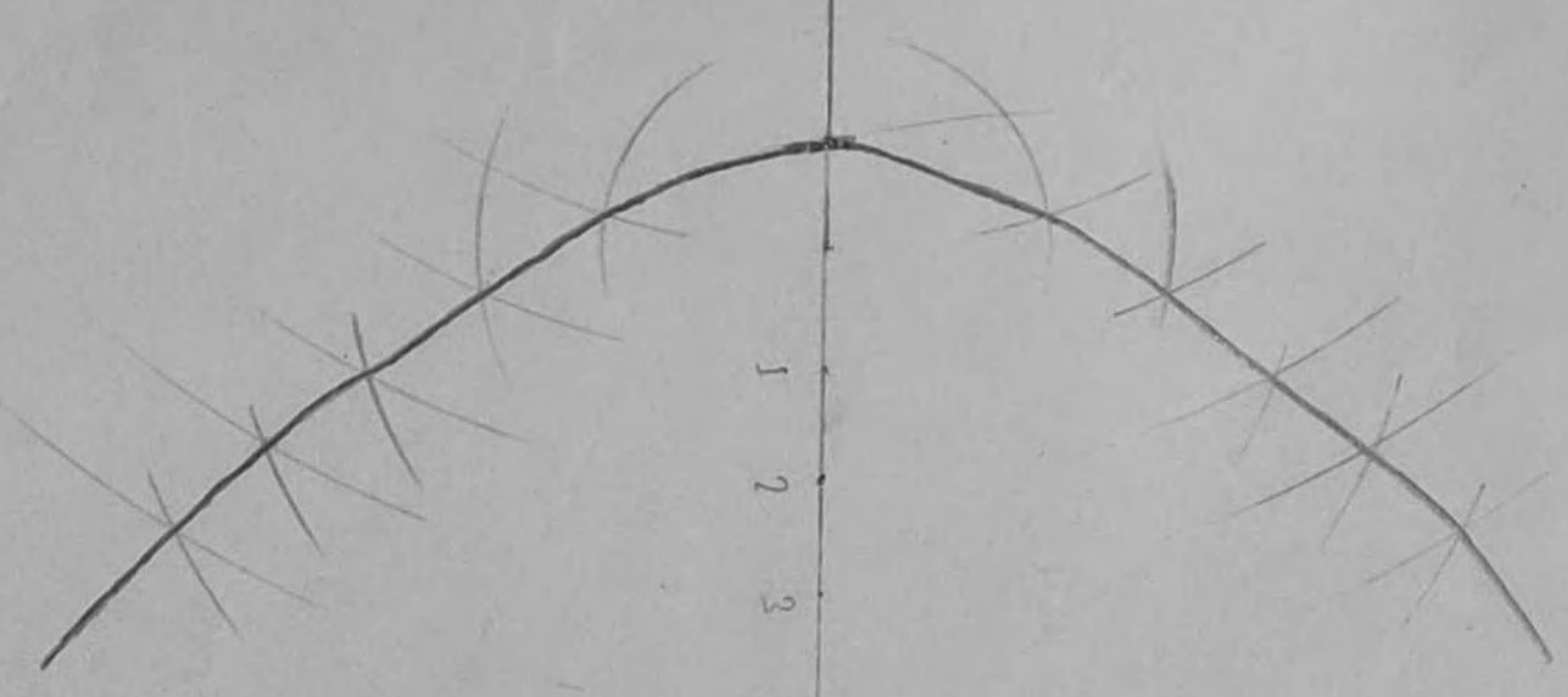

5 4 3 2 1

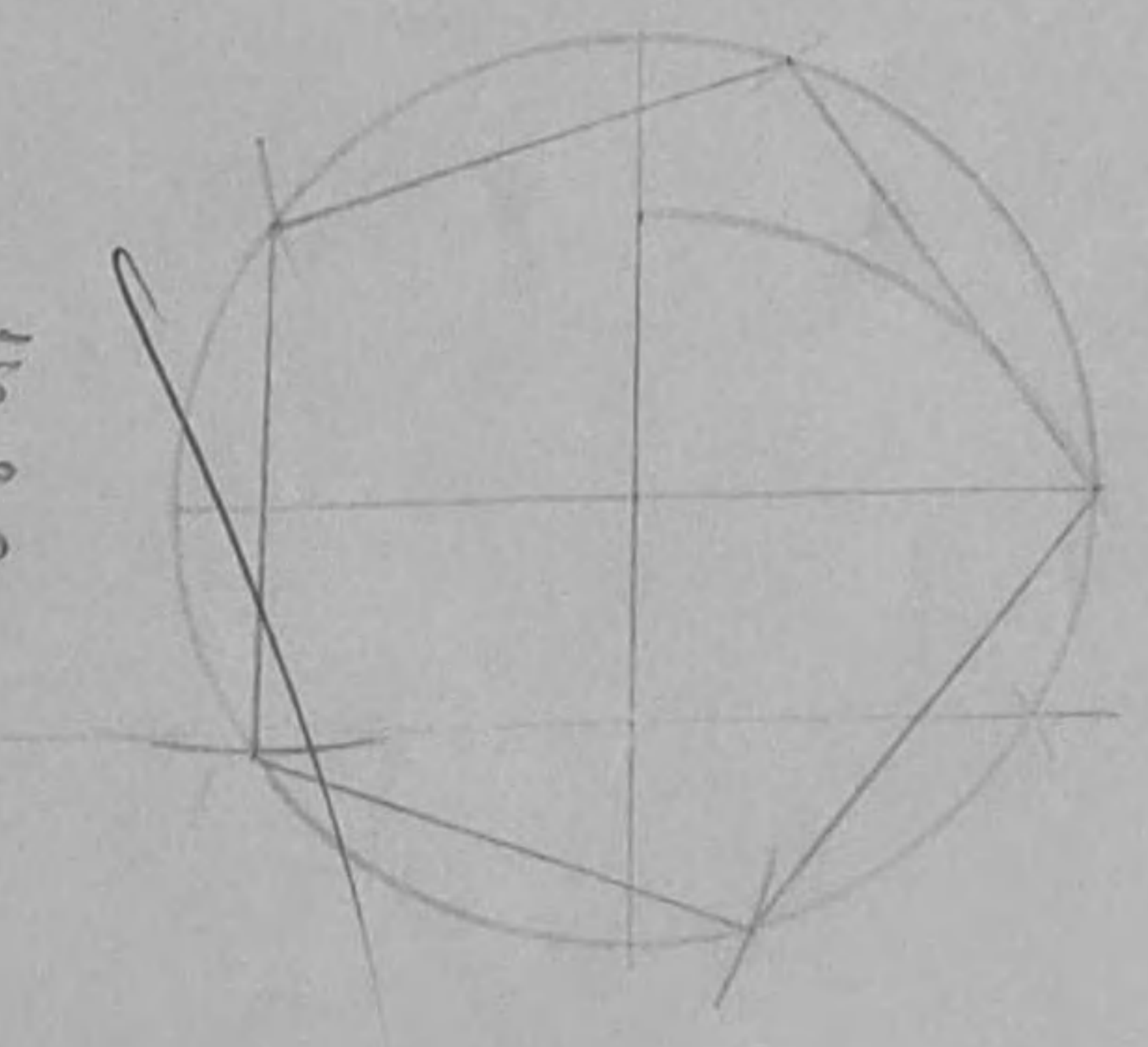

Fig 2.a

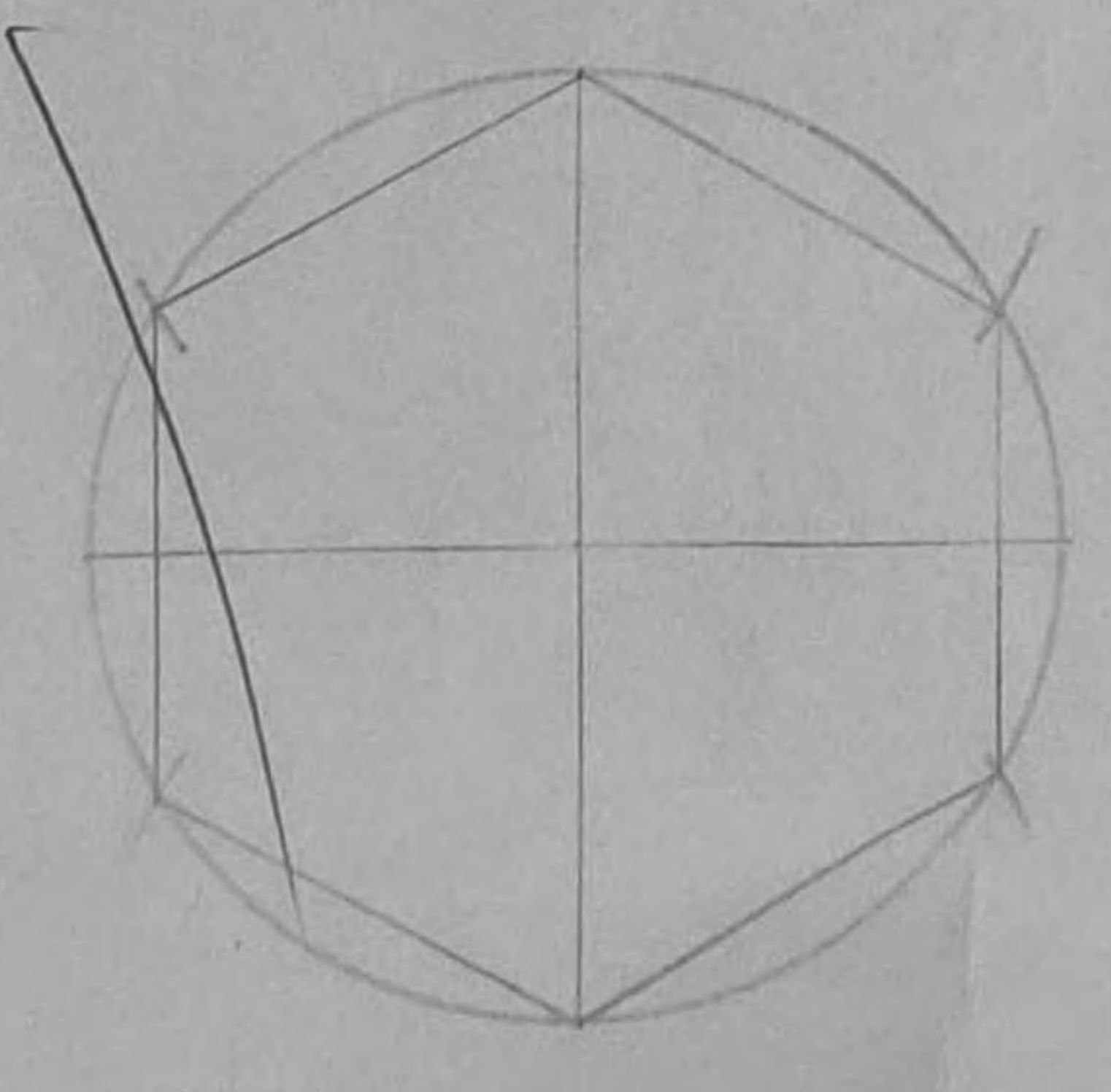

Fig 2.b

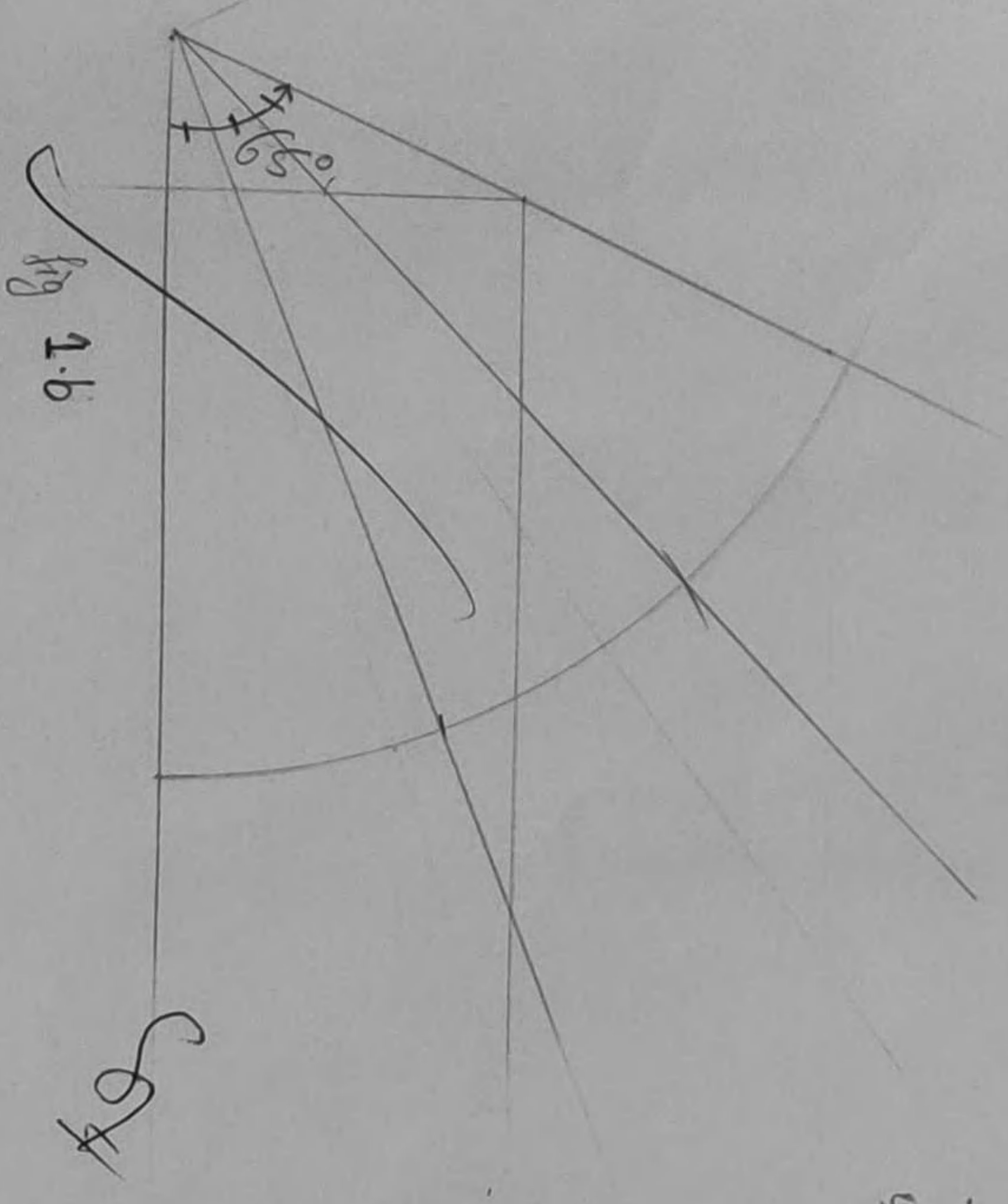

Fig 1.b

5 4 3 2 1

Fig 1.10

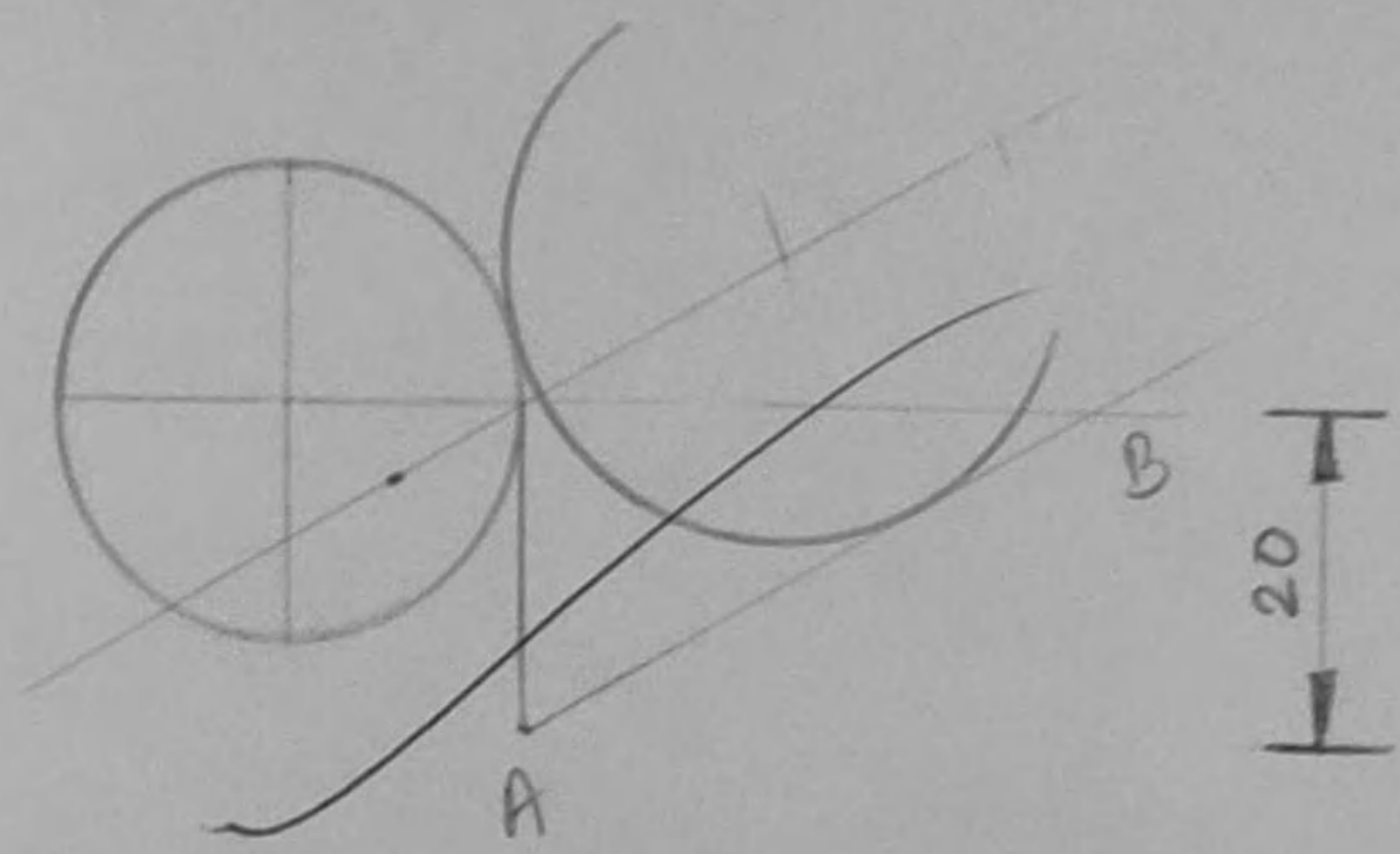

fig 4.a

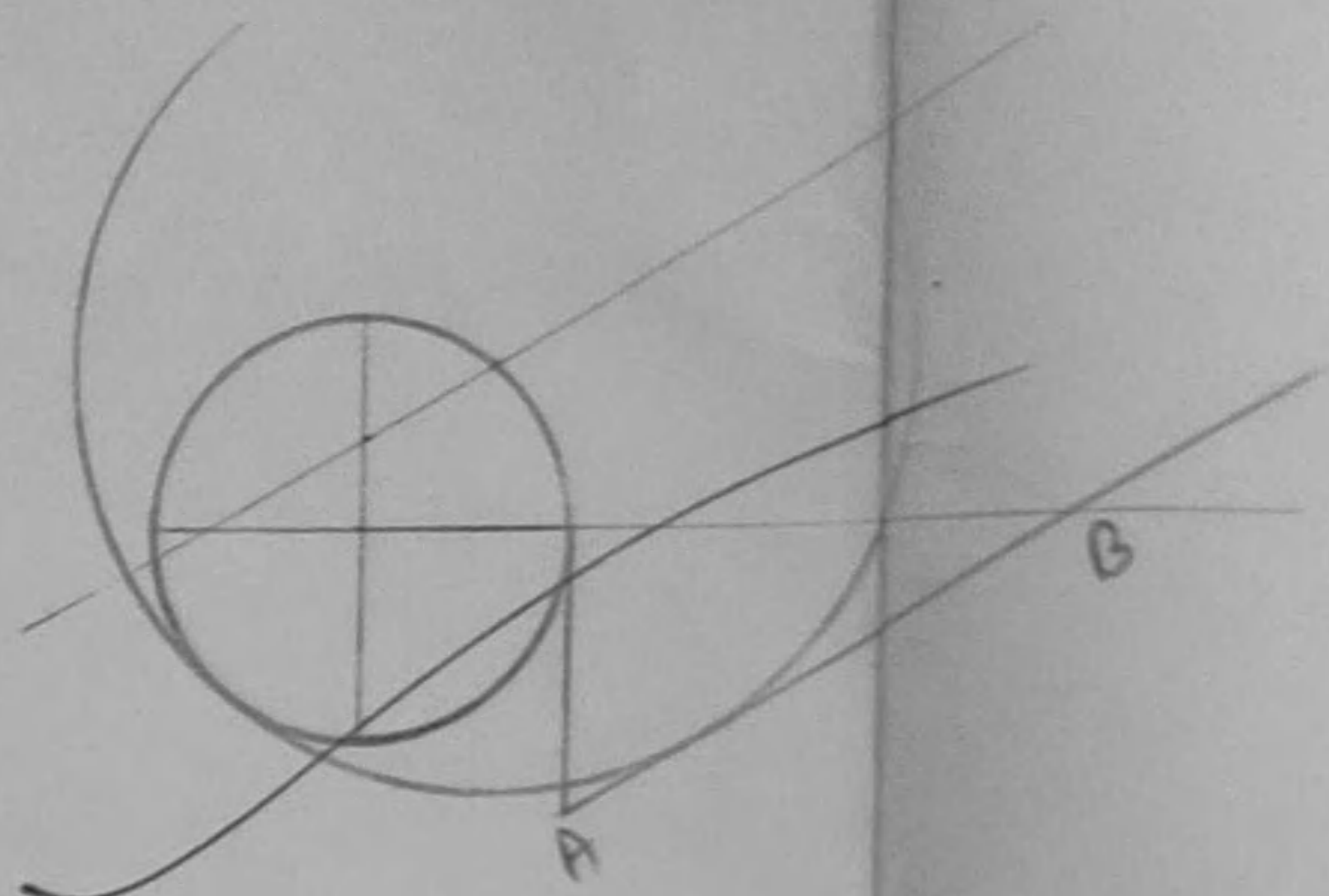

fig 4.b

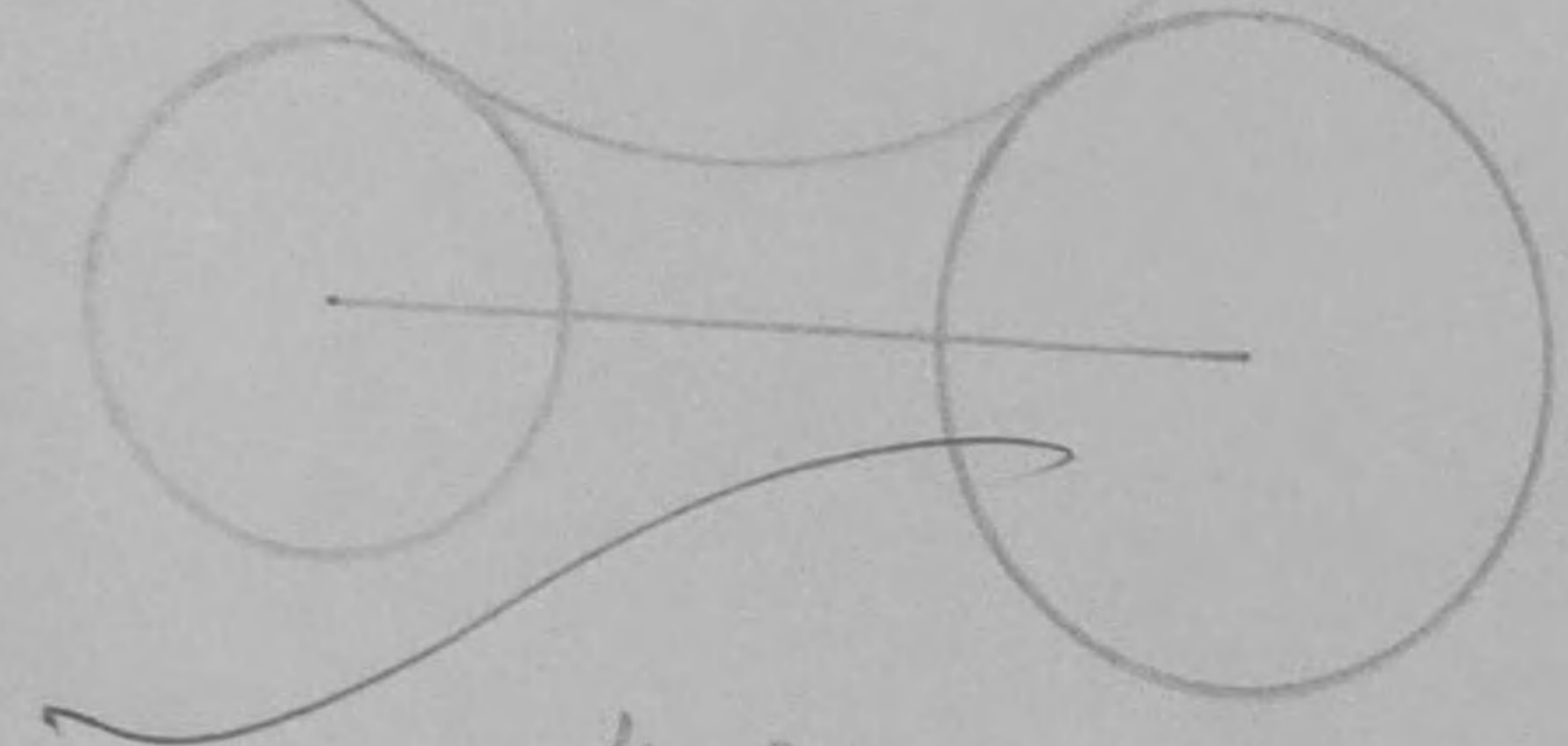

fig 5.a

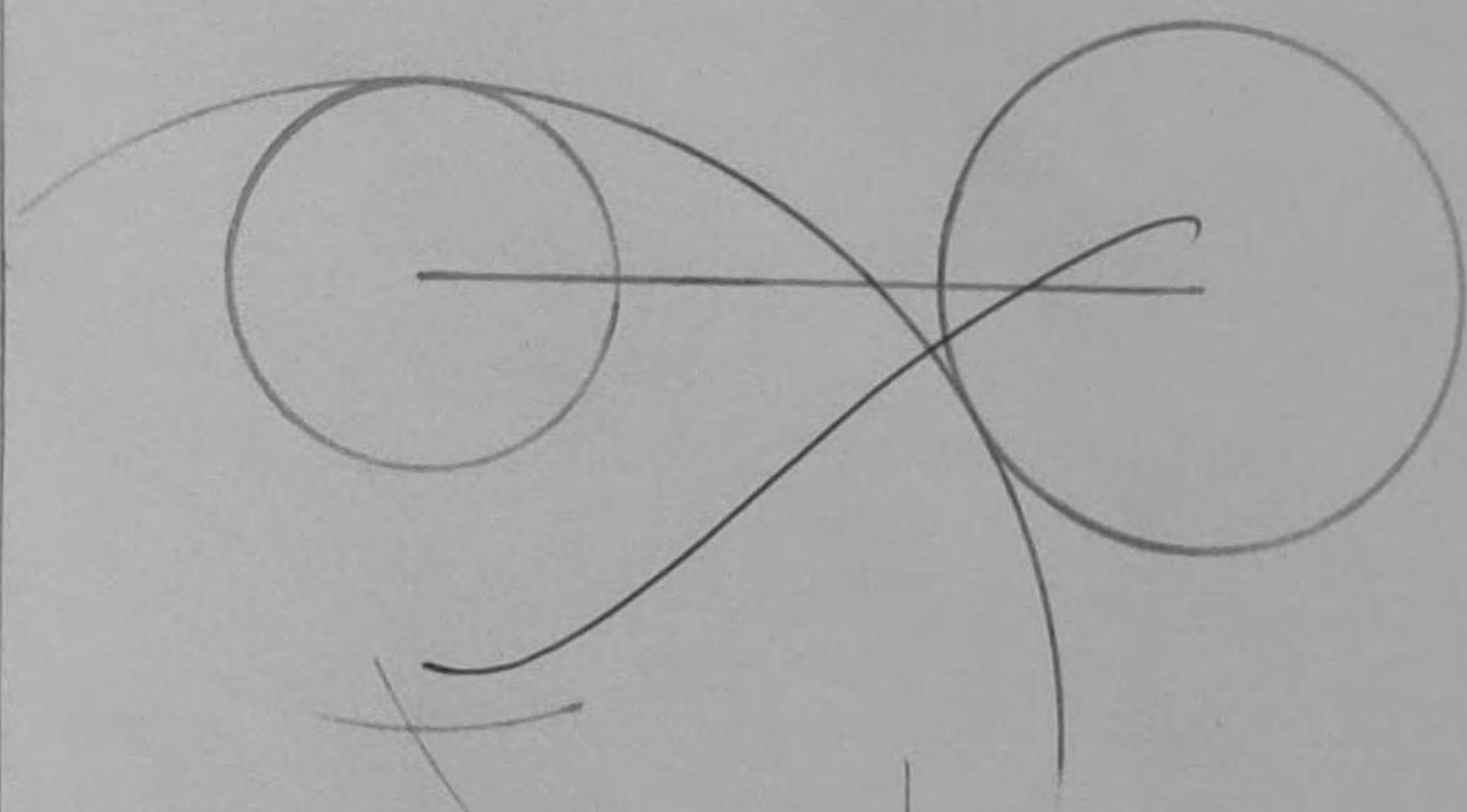

fig 5.b

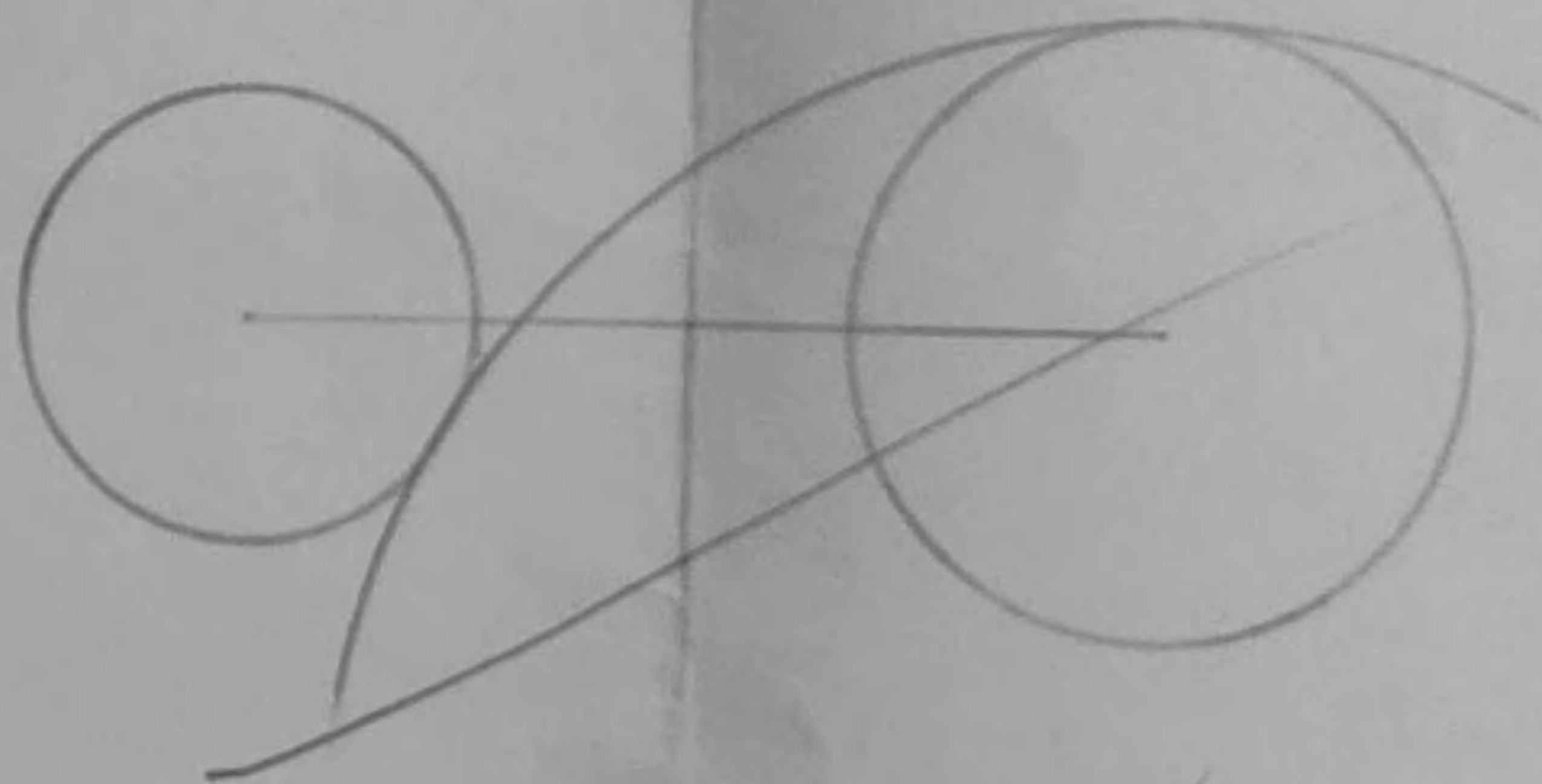

fig 5.c

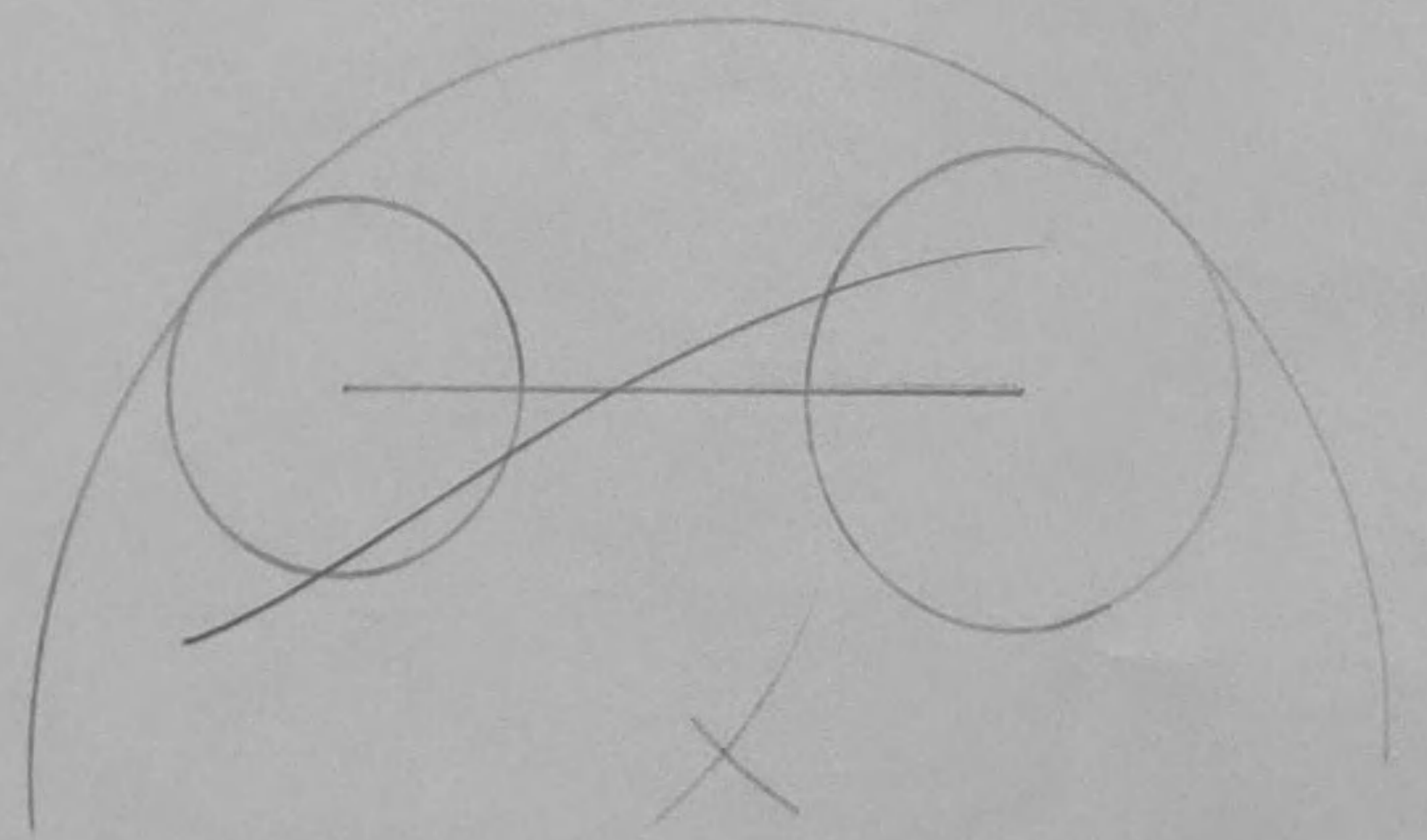

fig 5.d

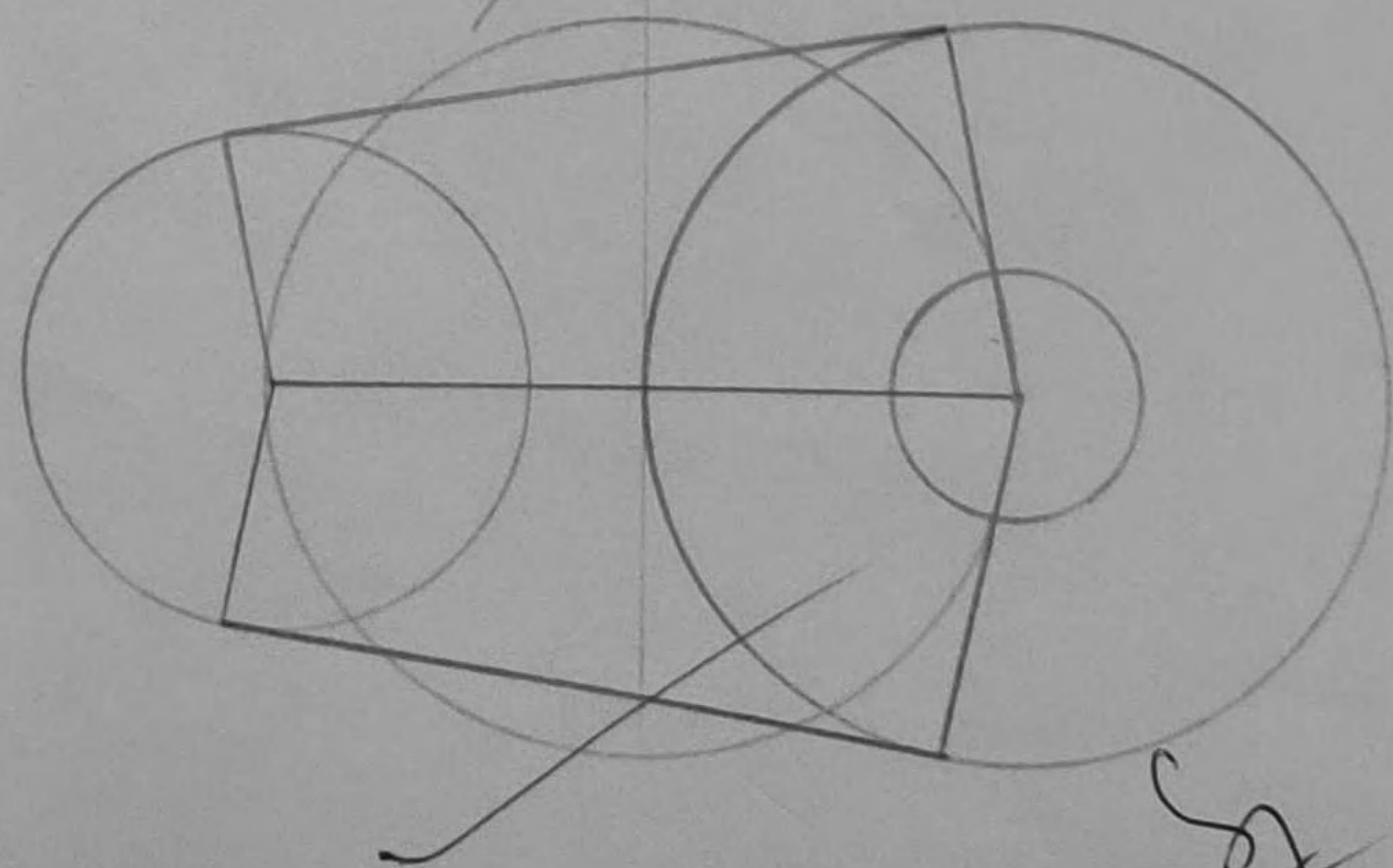
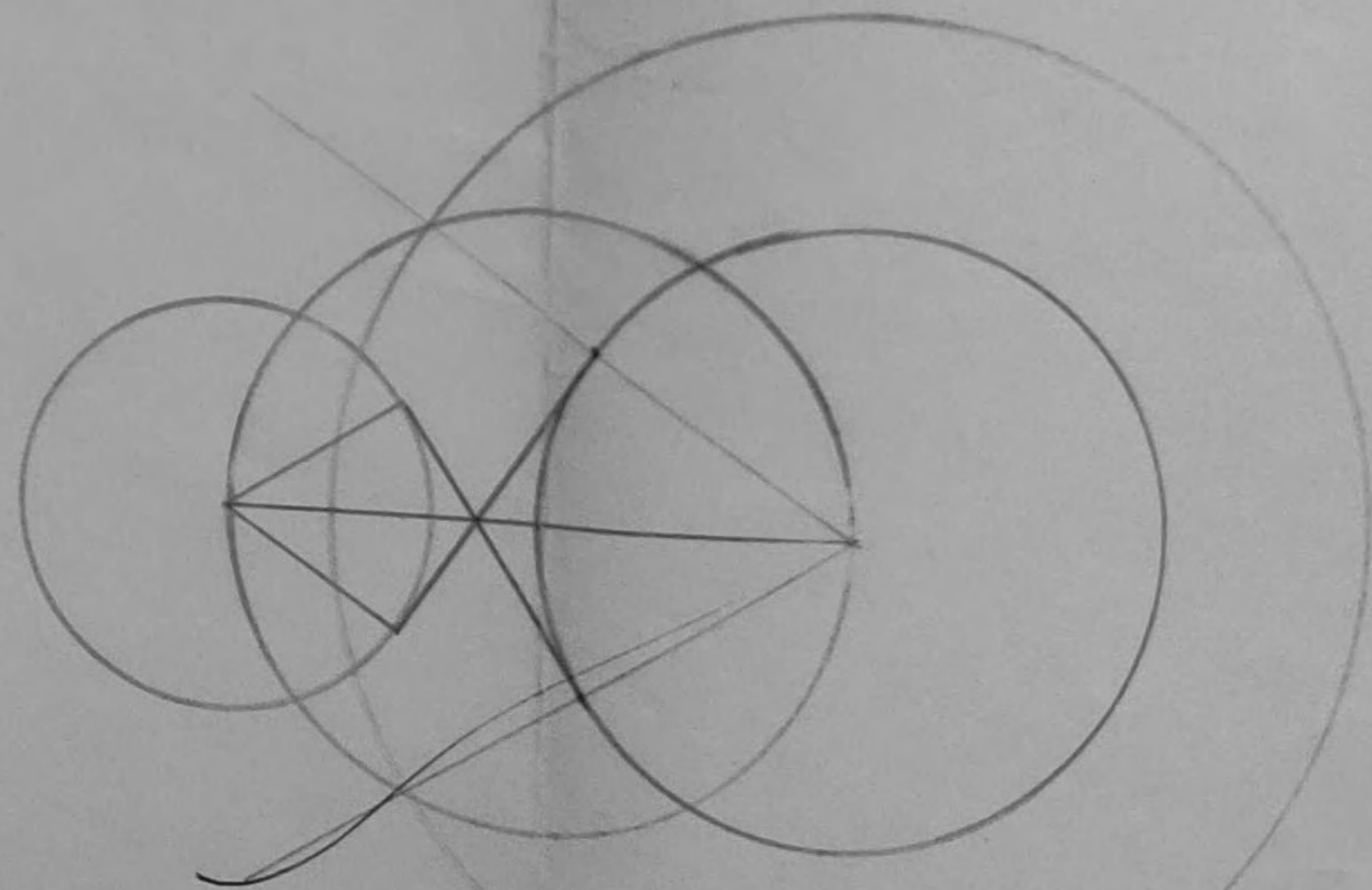

fig 6



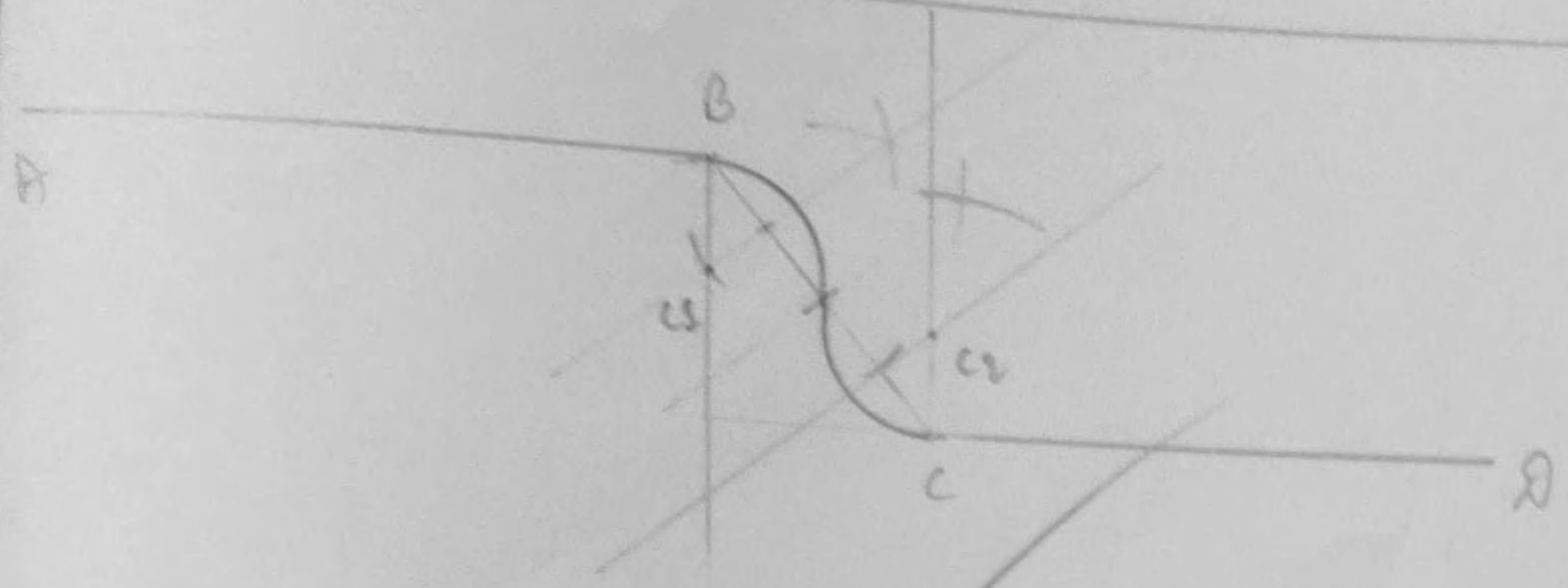

Fig 7

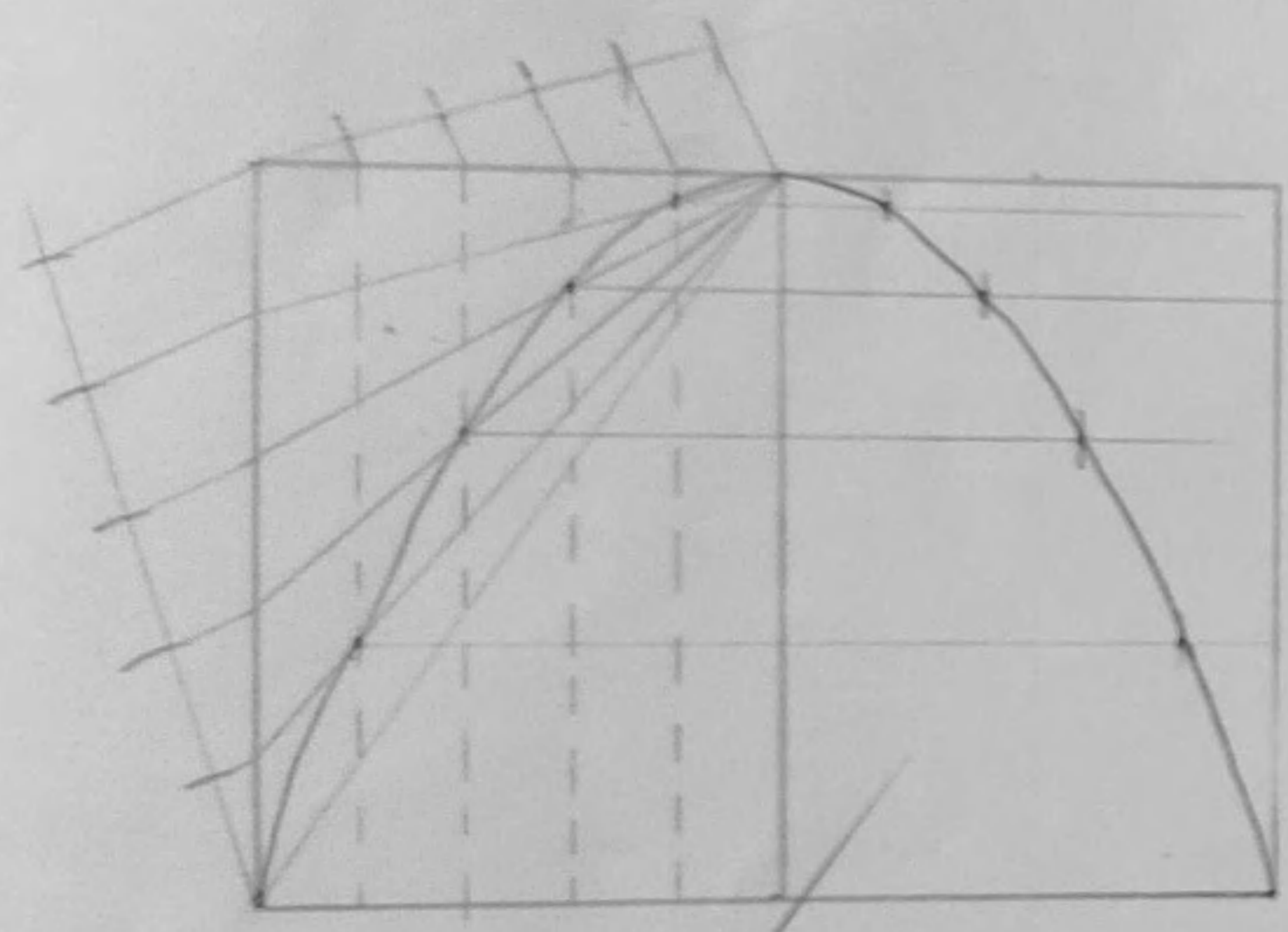

Fig. 8

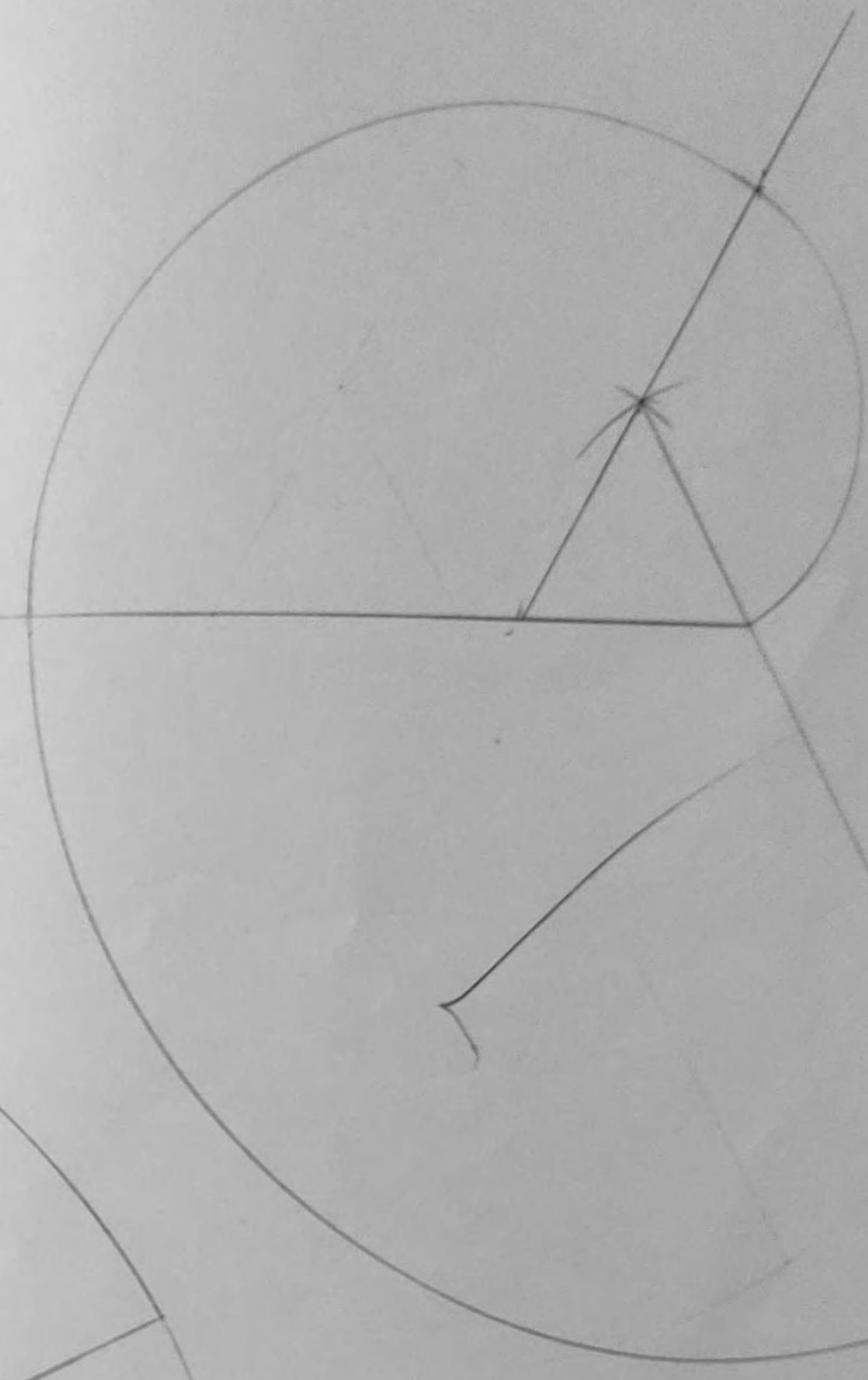

Fig 11-a

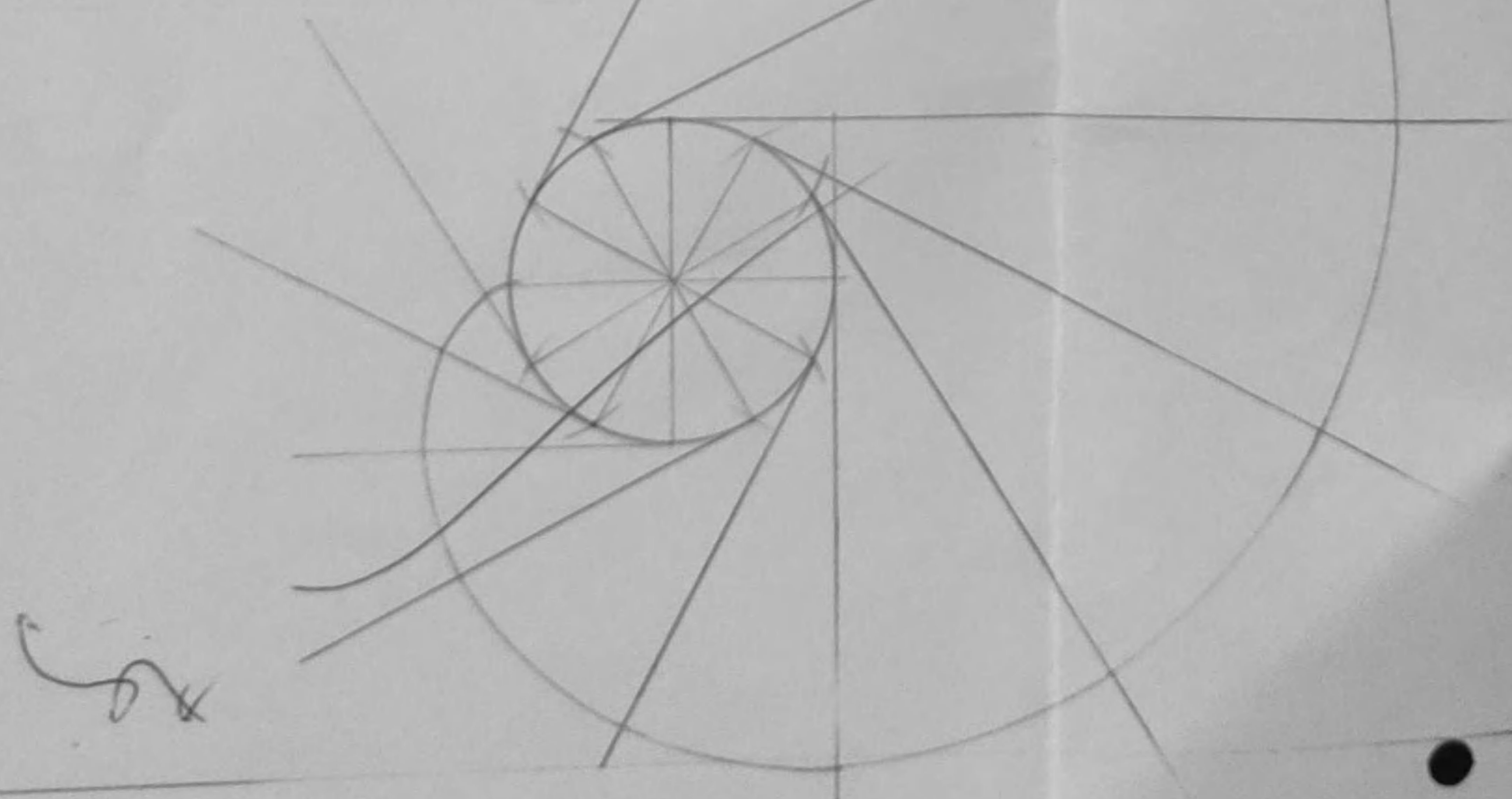

Fig 11-b

or

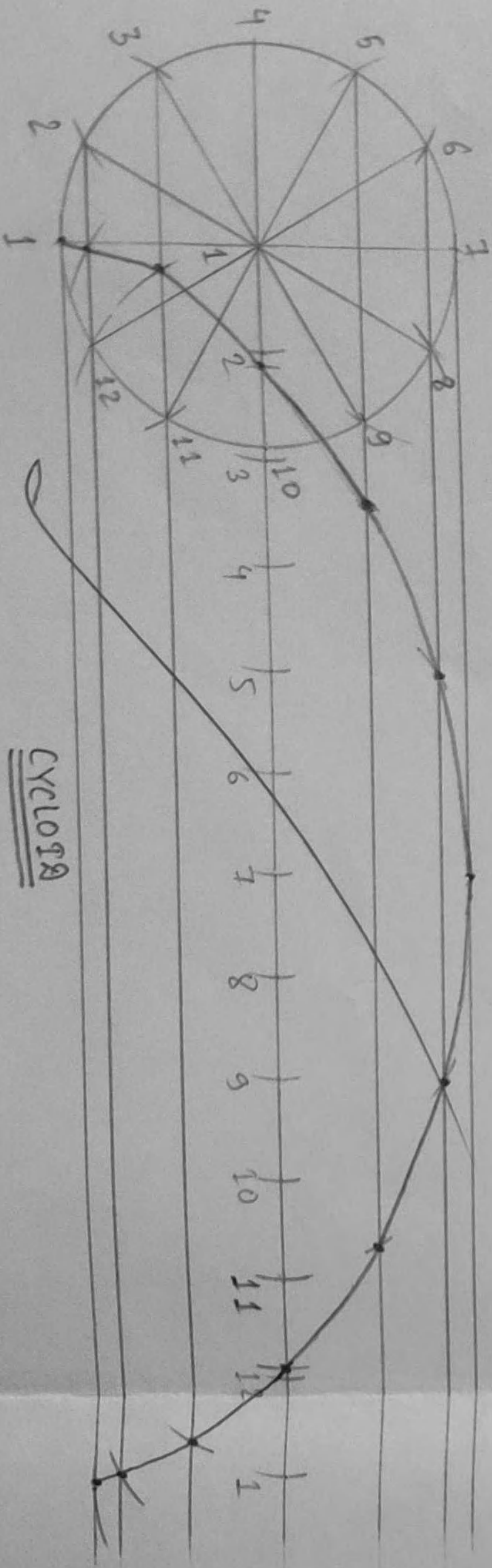

fig 12

CYCLOID

Signature

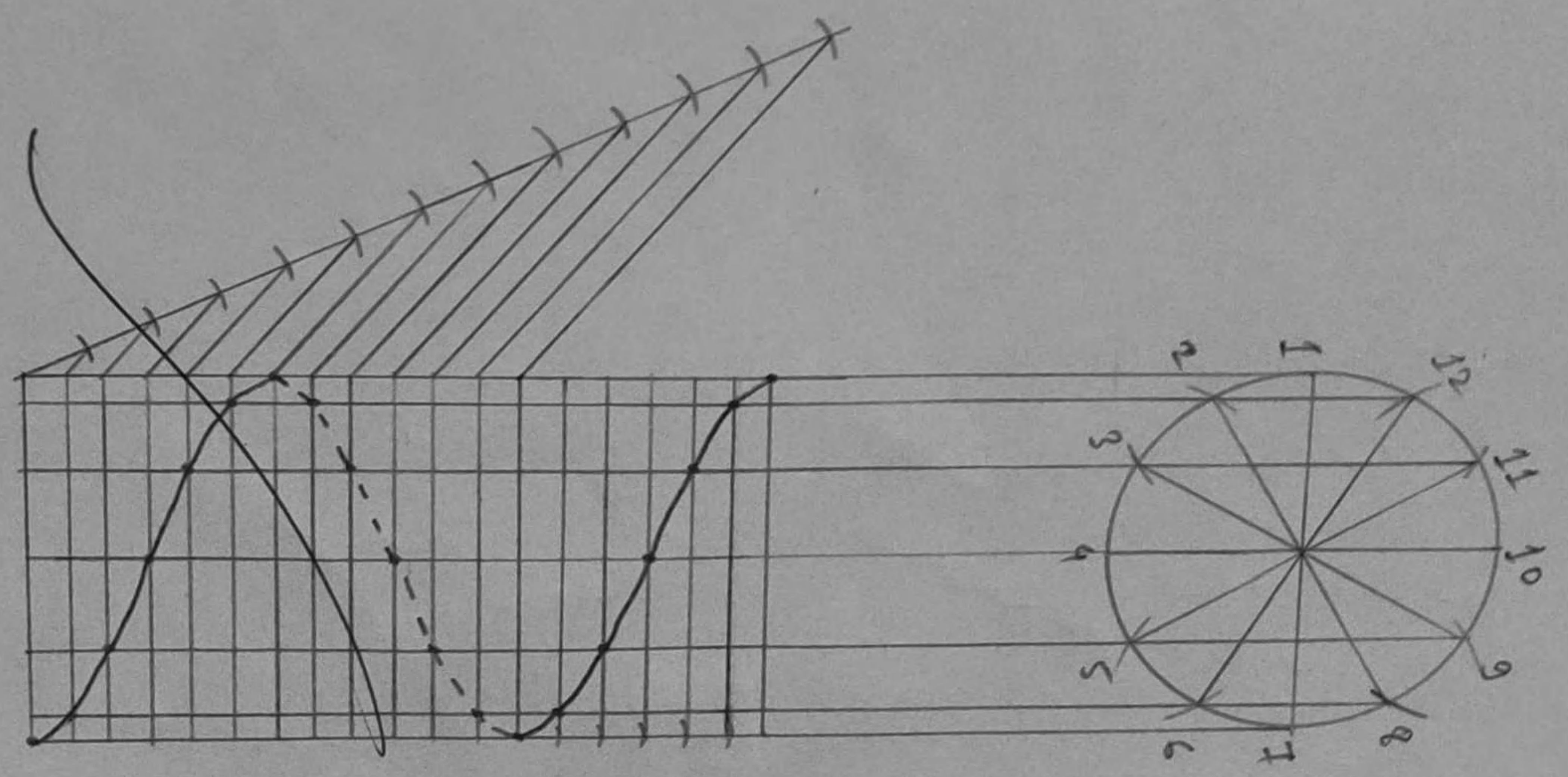

fig. 14

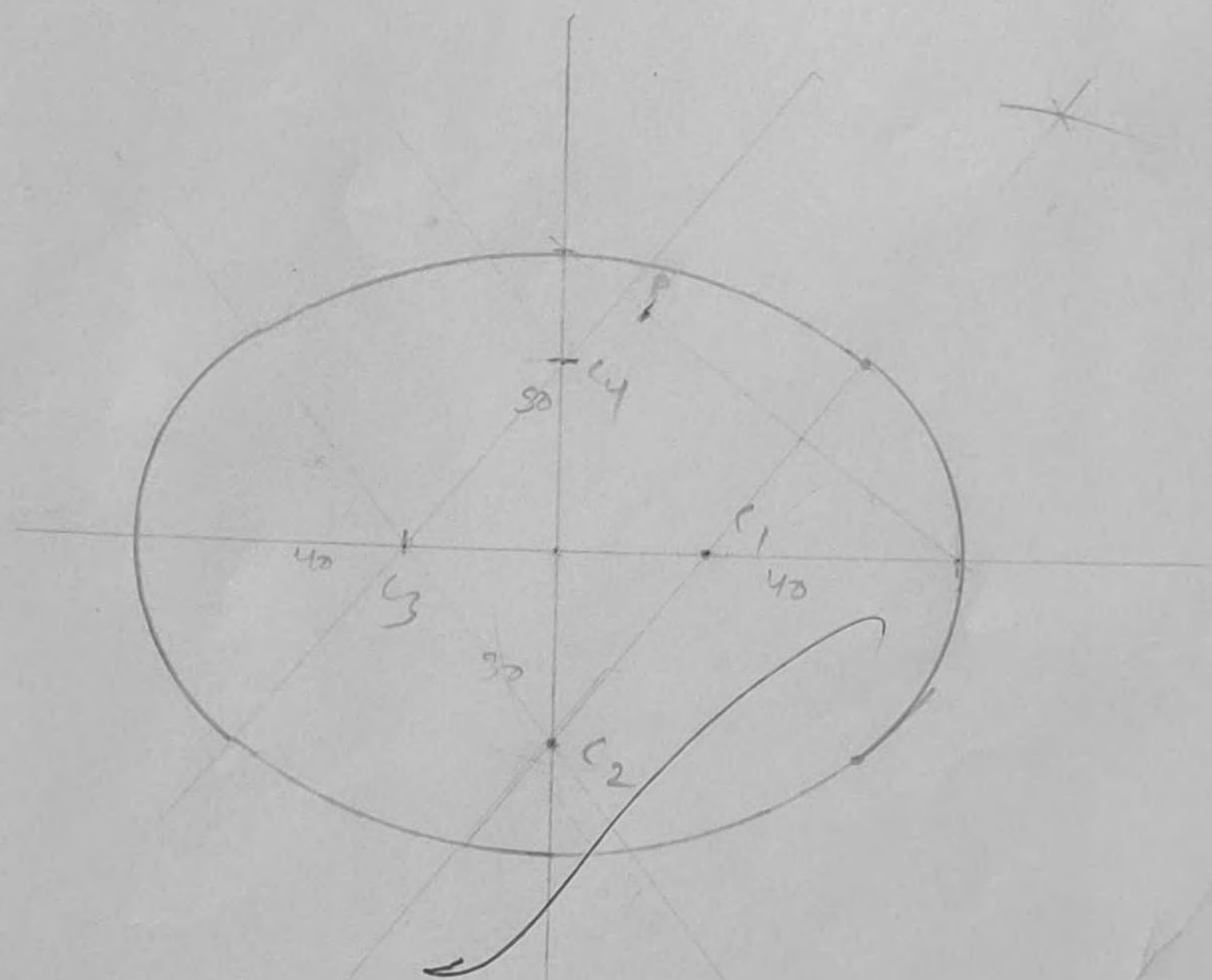

fig 9.b

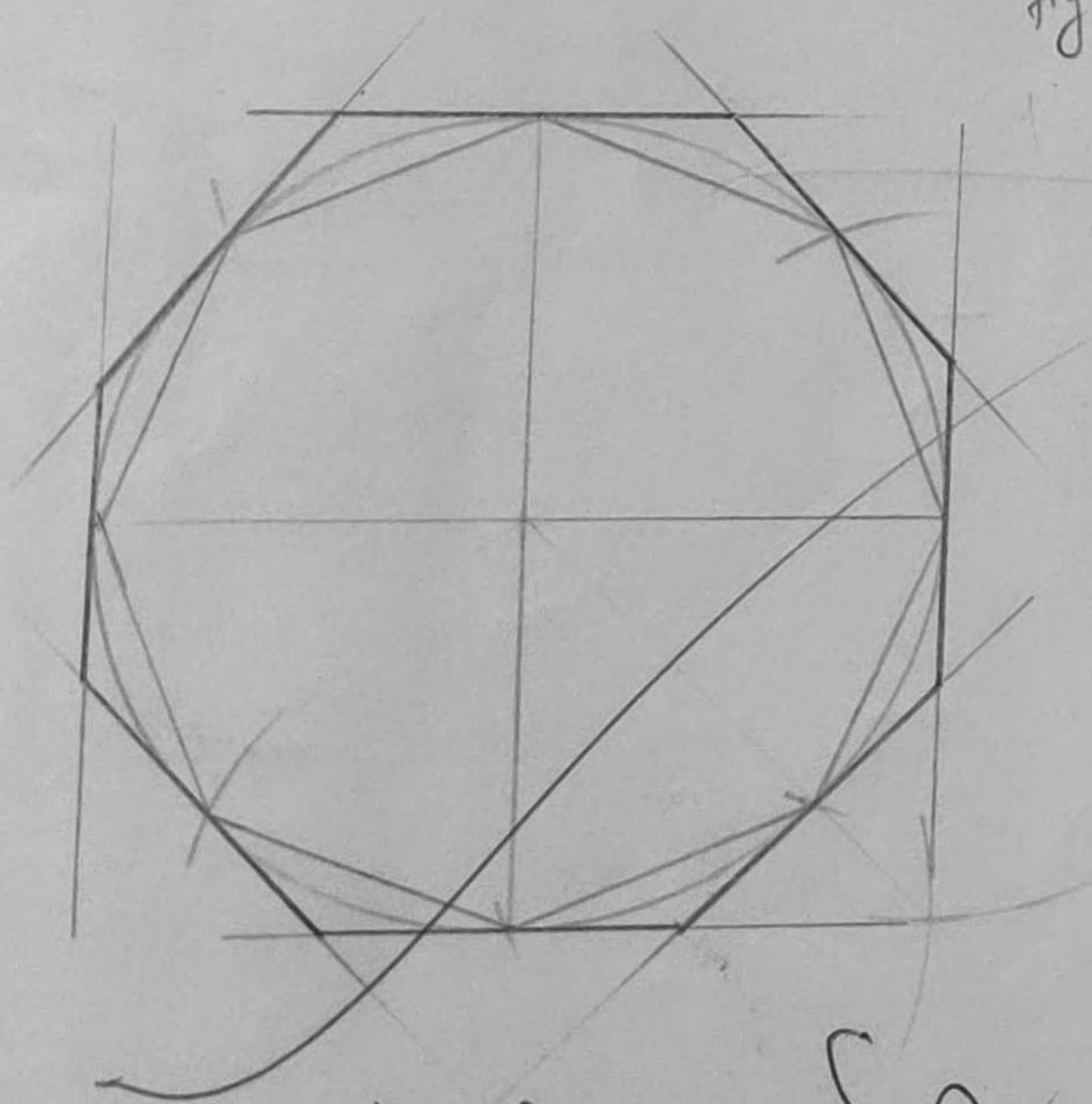

fig 2c

COX

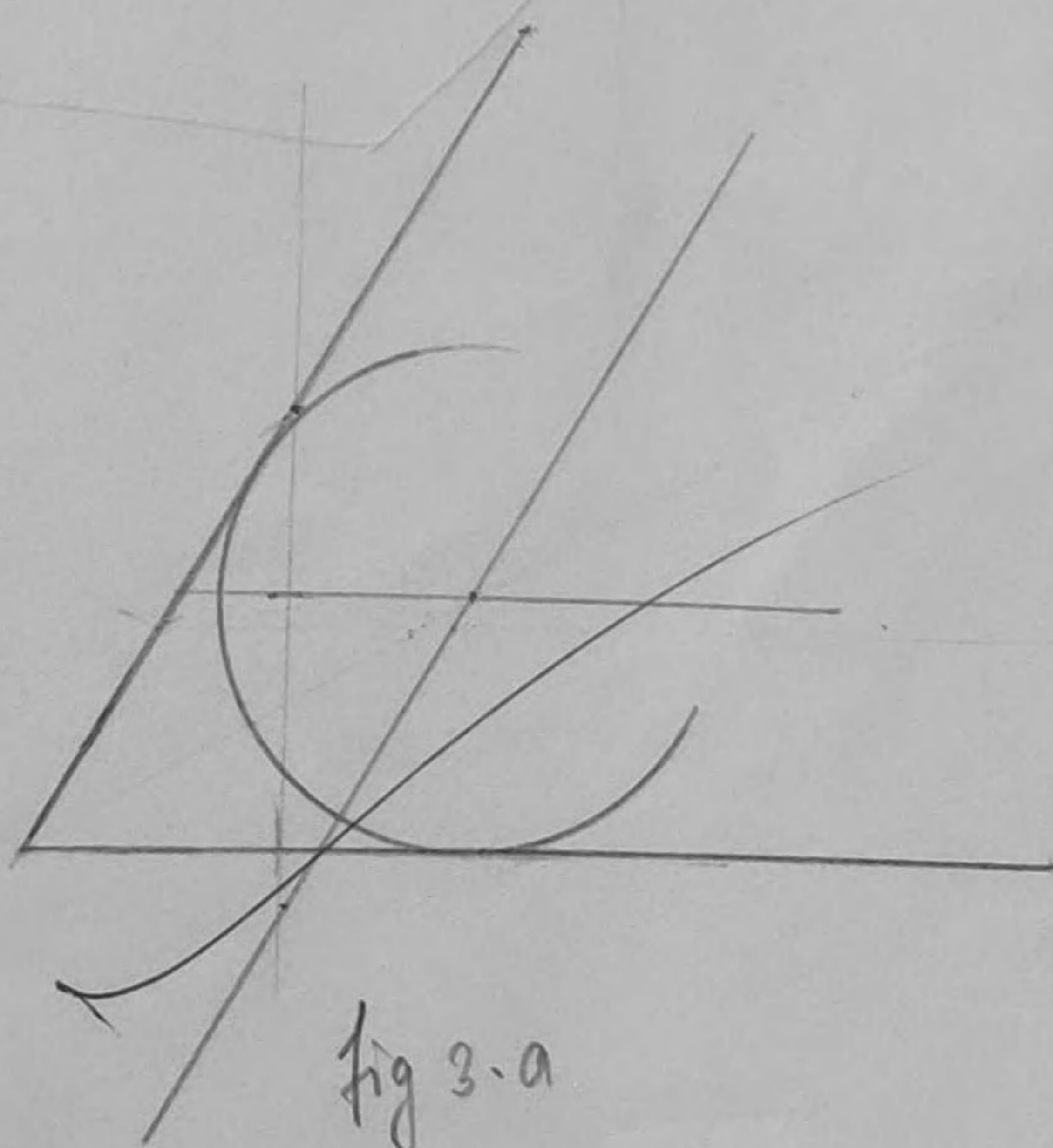

fig 3.a

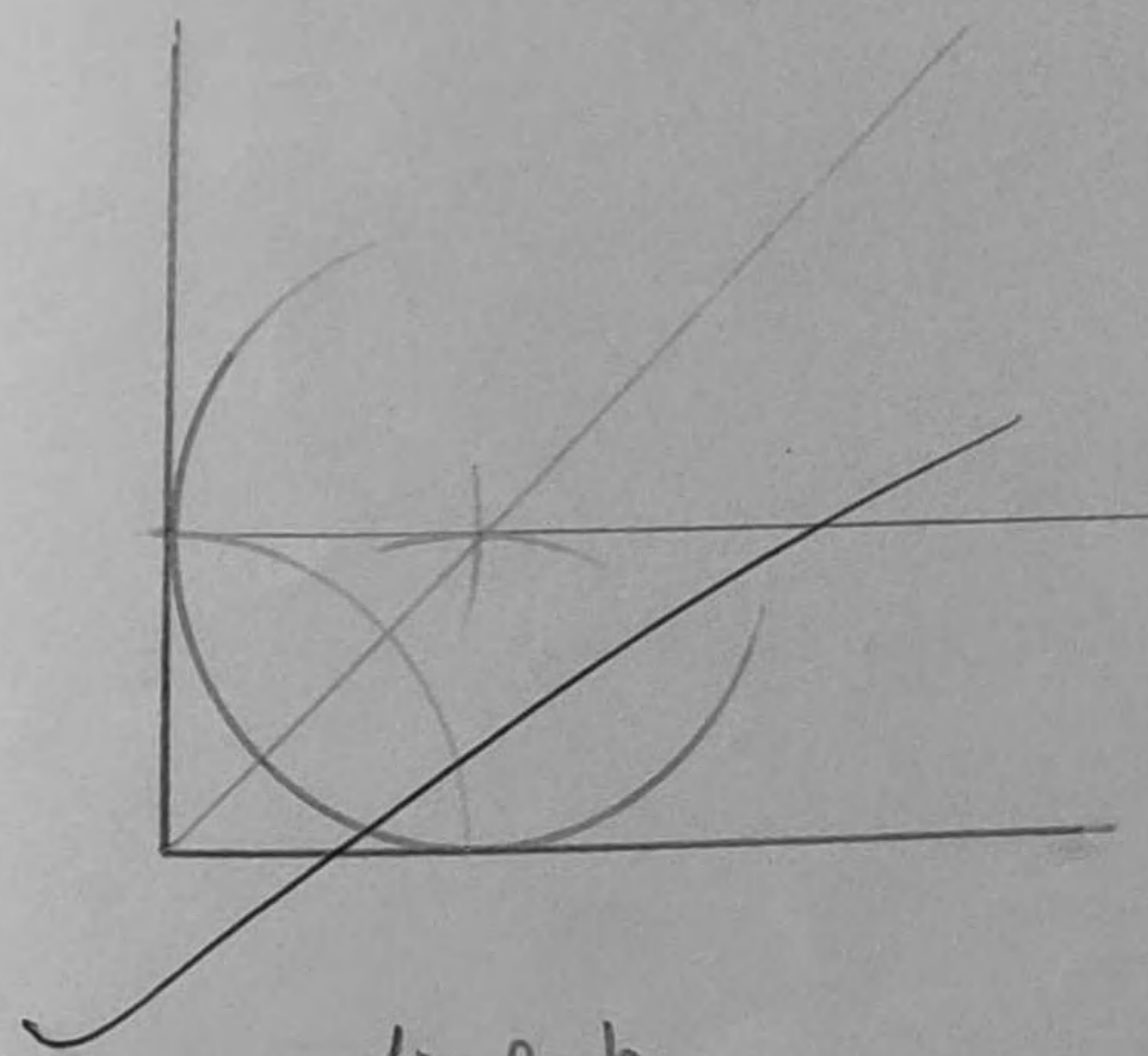

fig 3.b

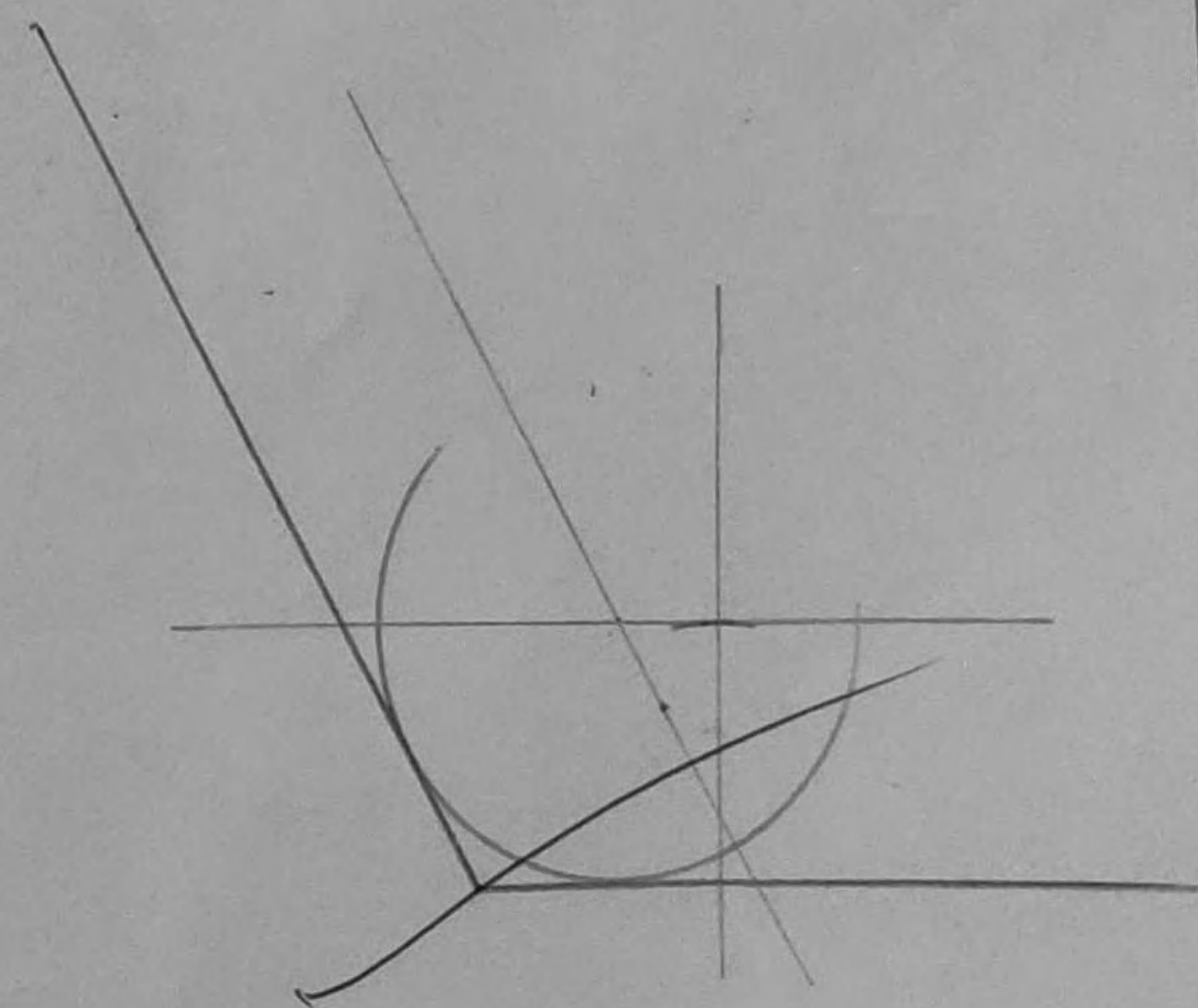

fig 3.c

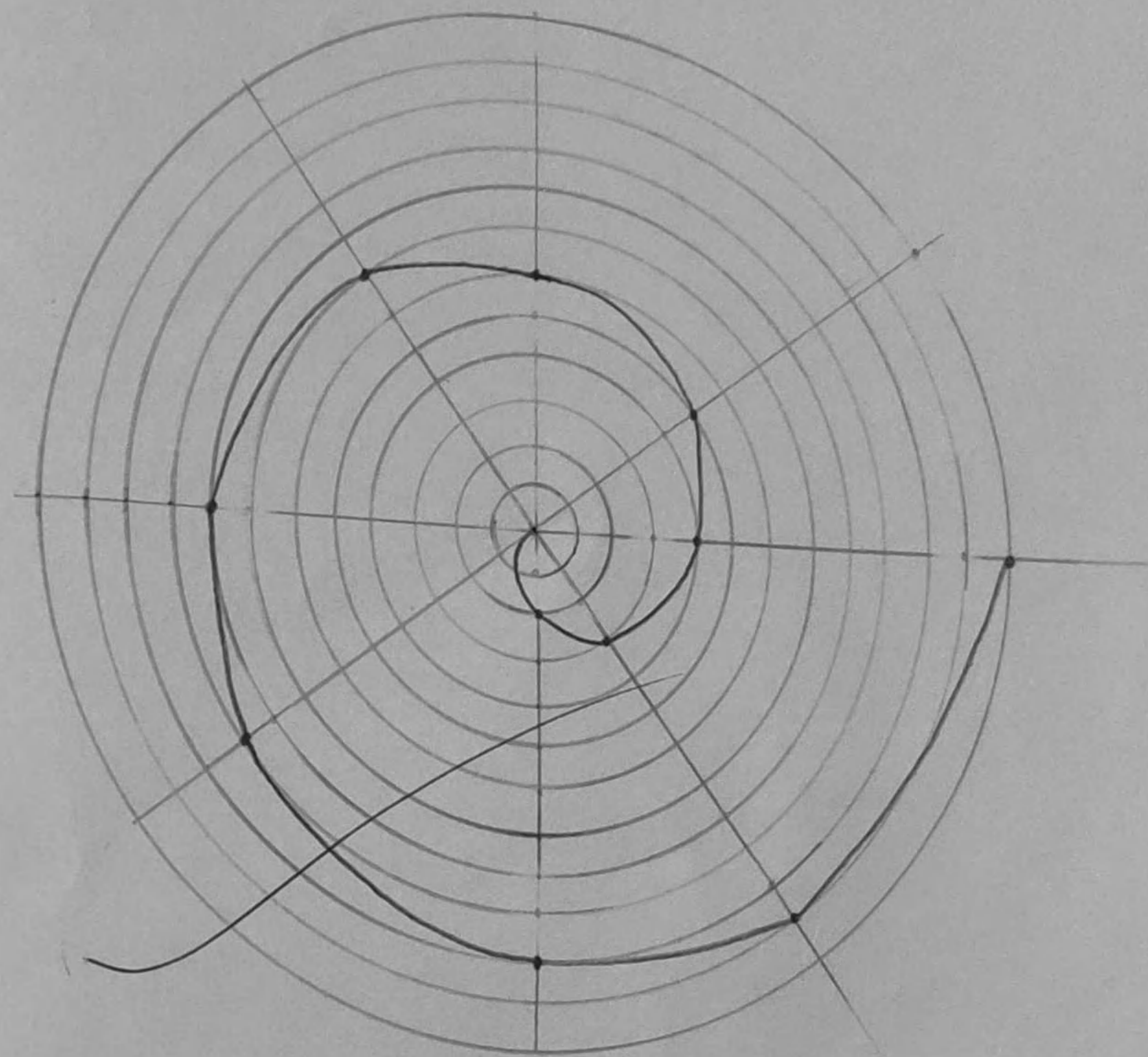
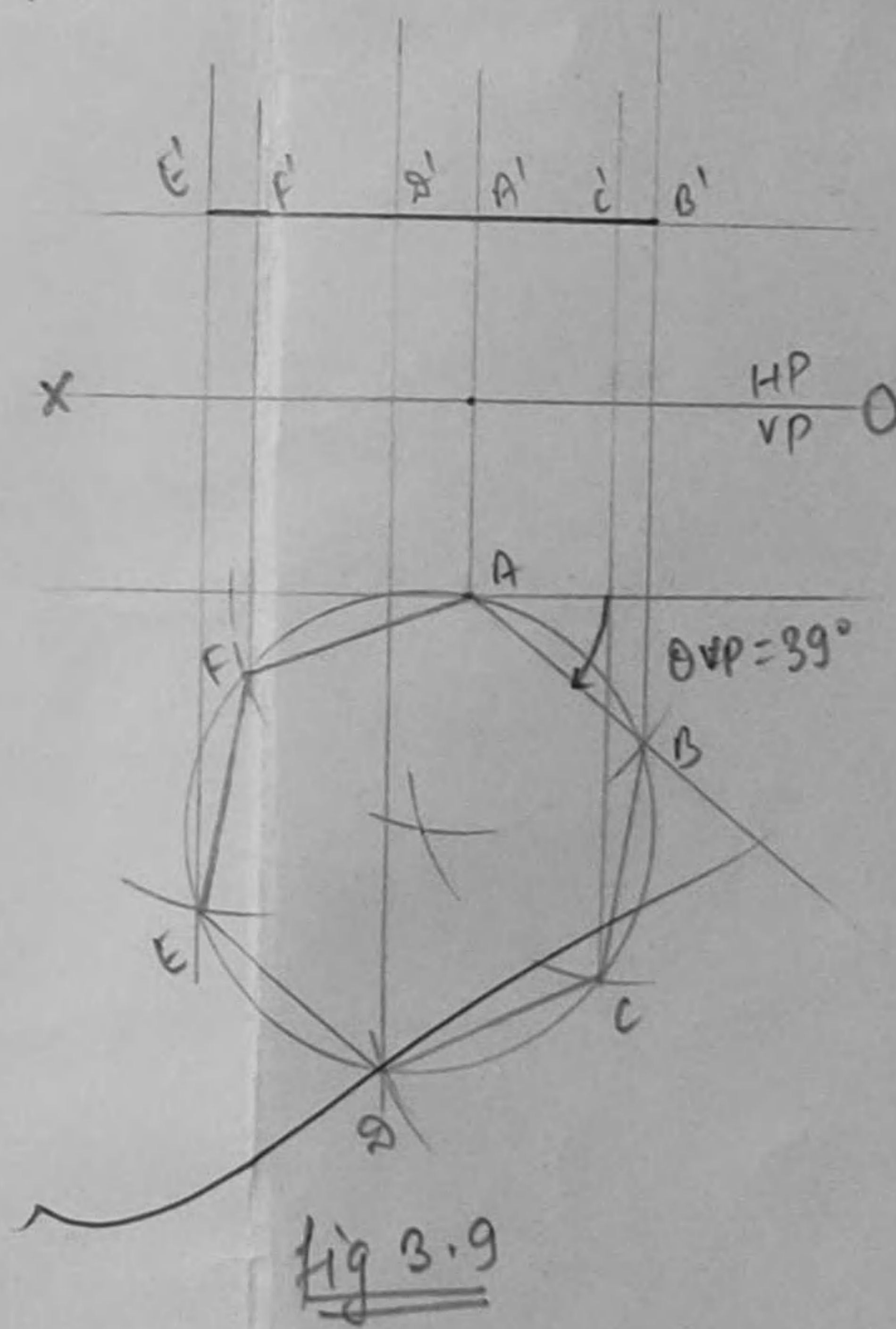
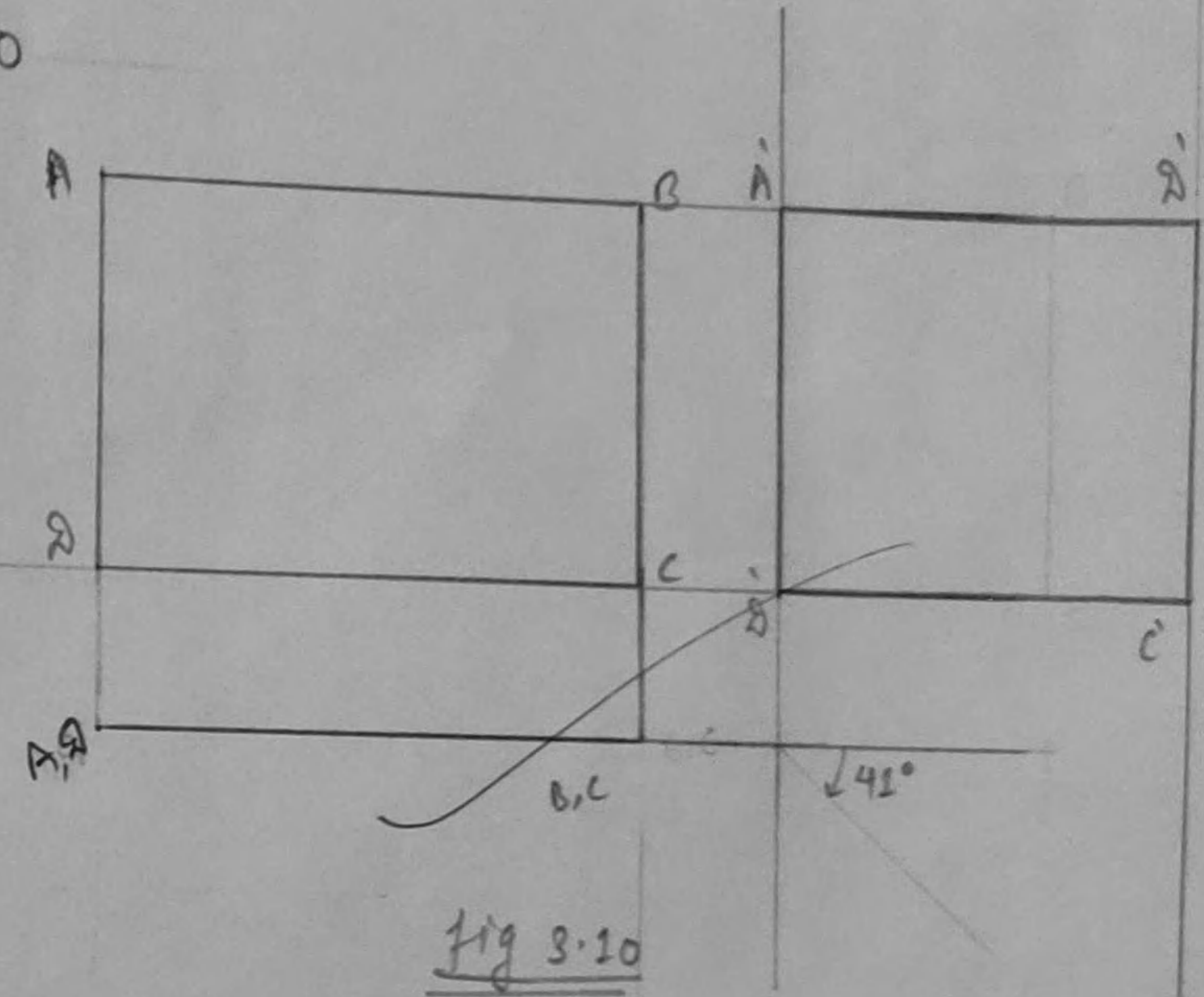
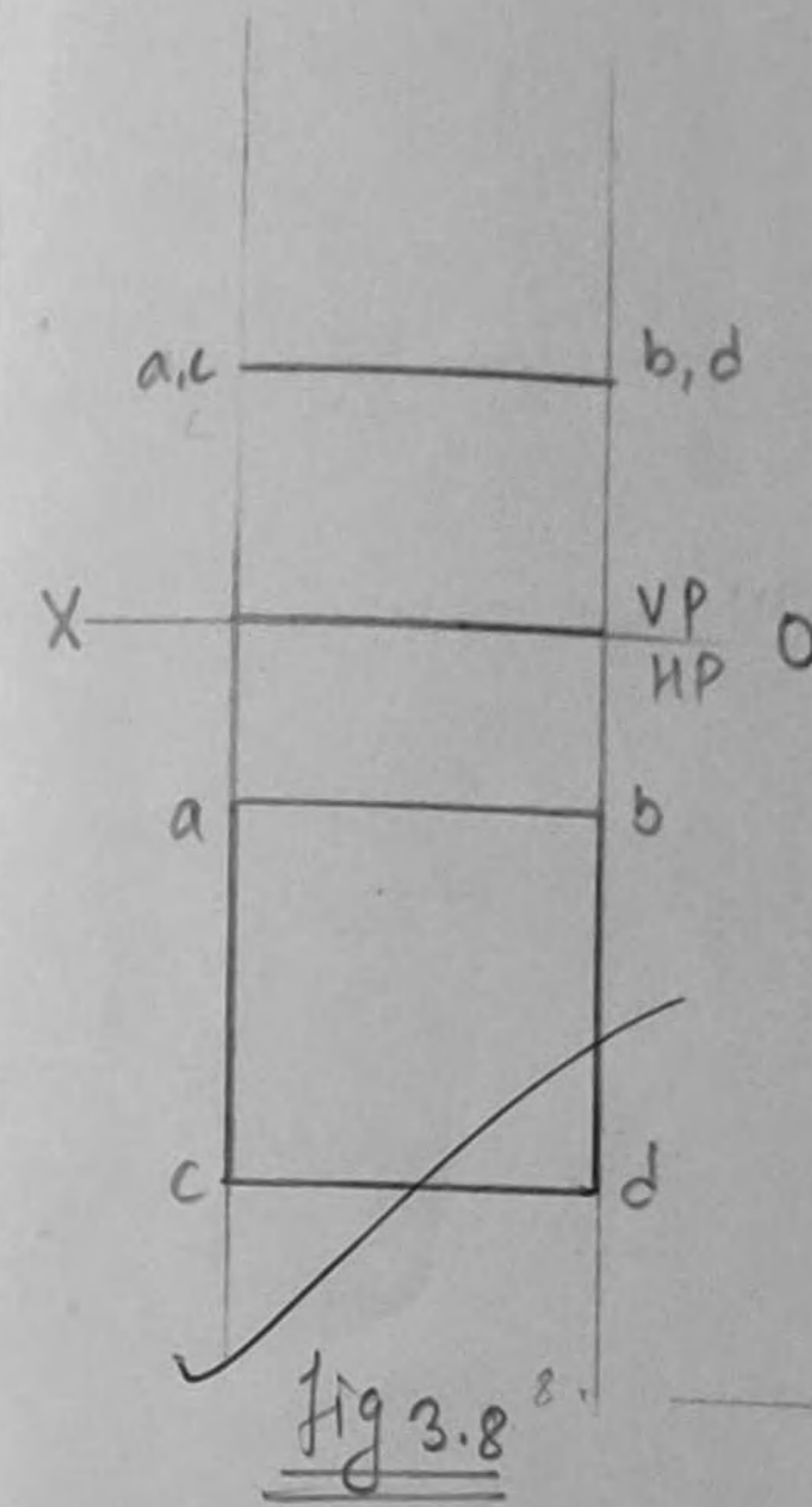
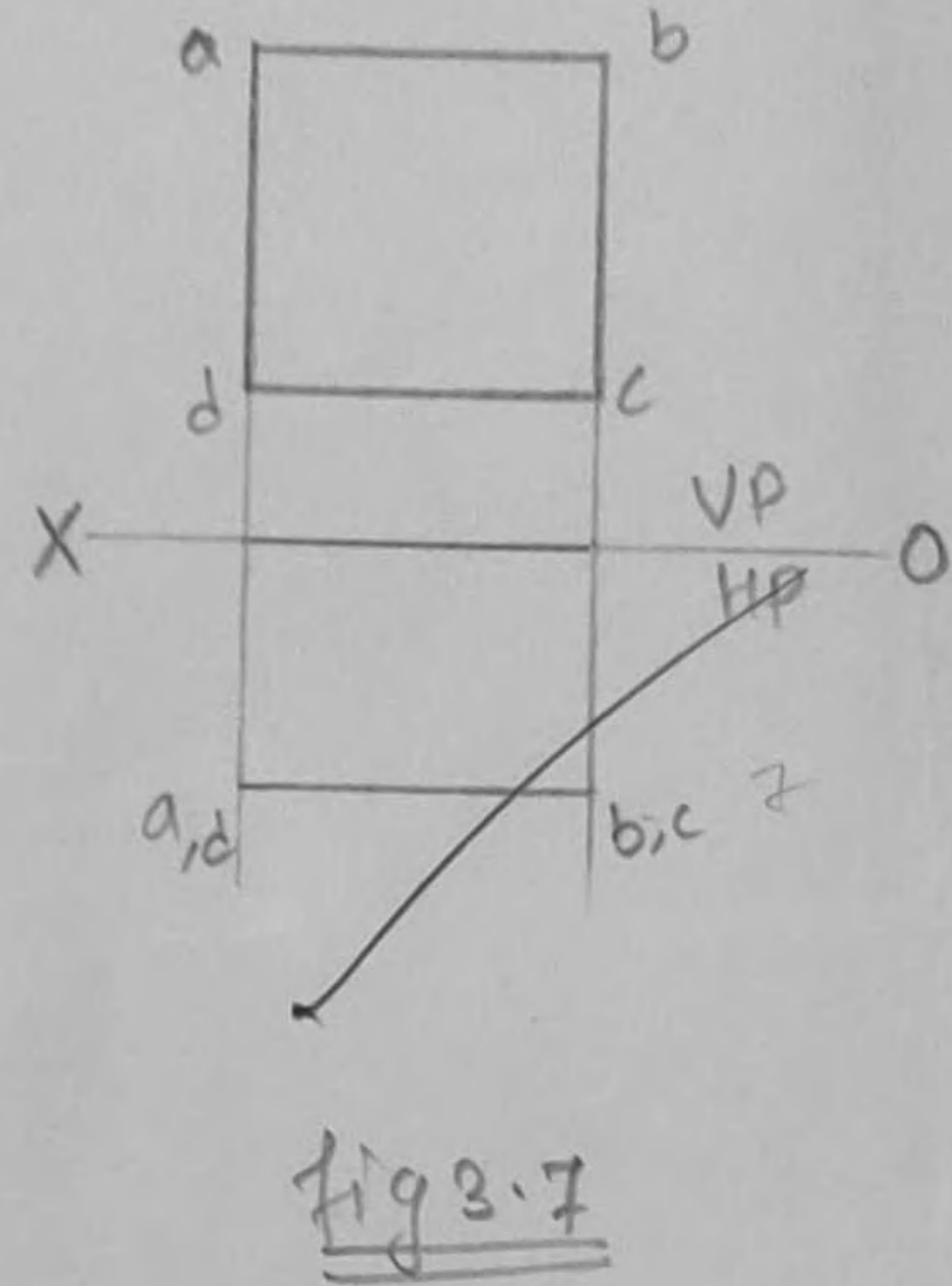
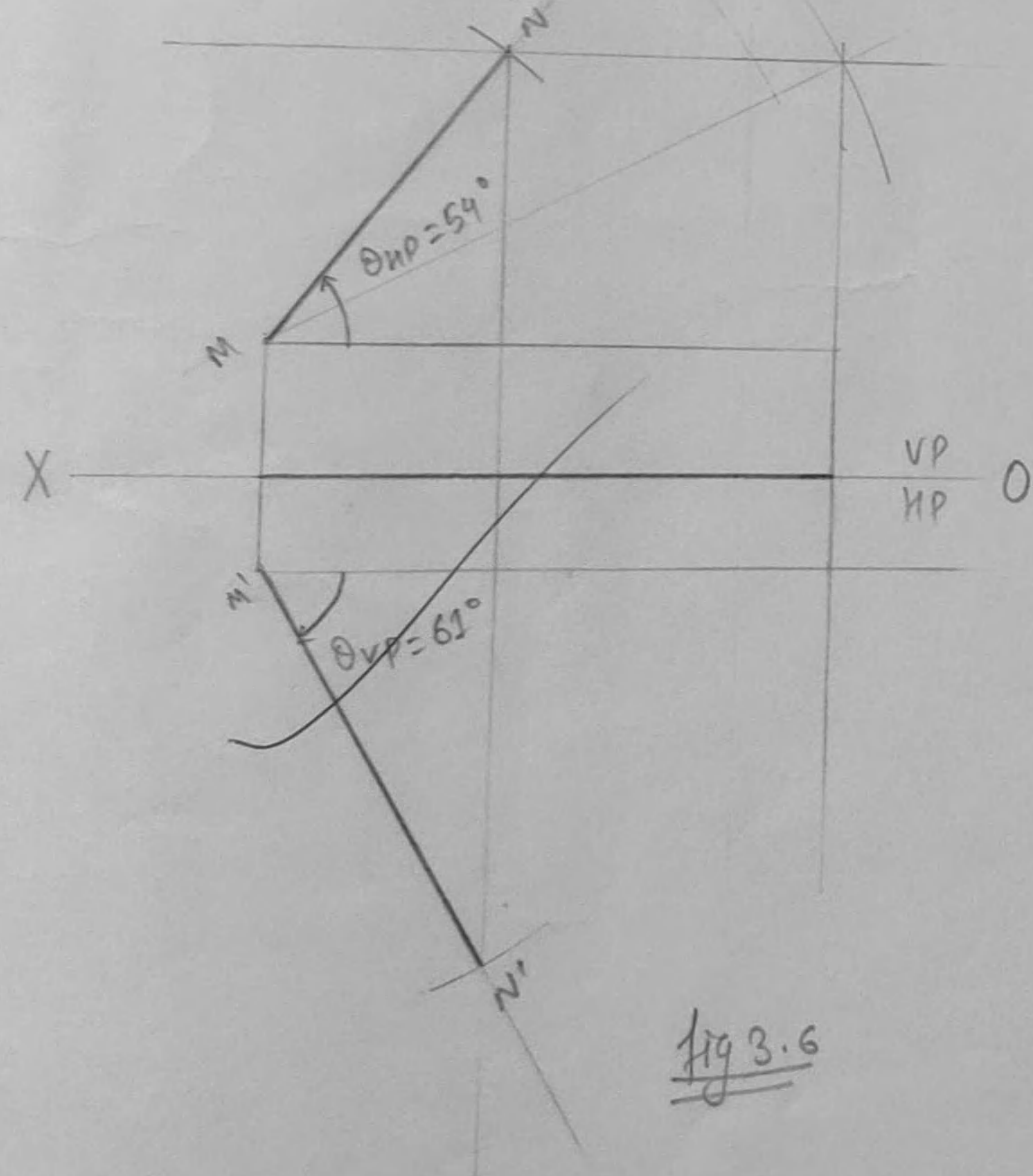
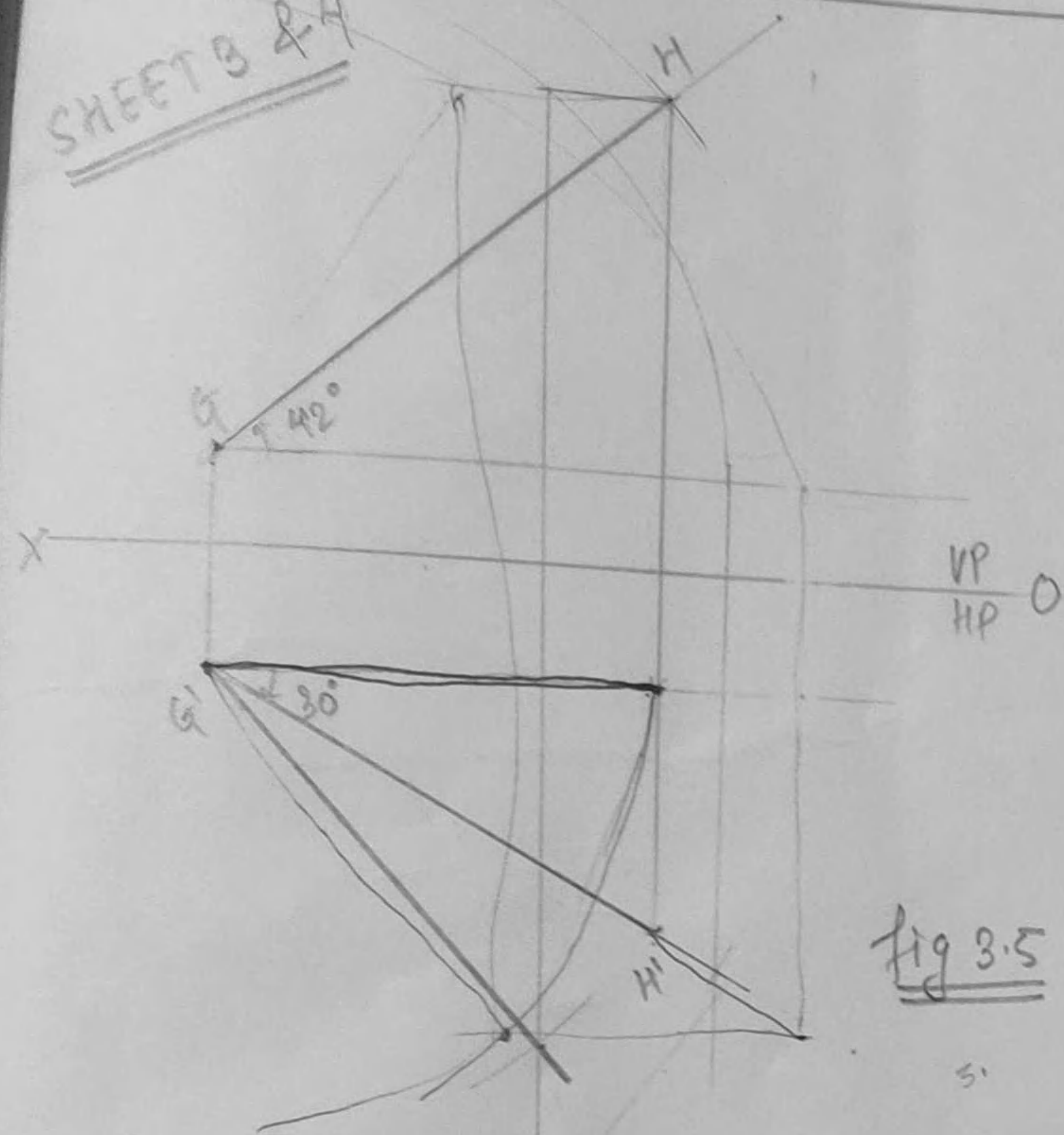

fig. 13

SHEET 3 & 4



304

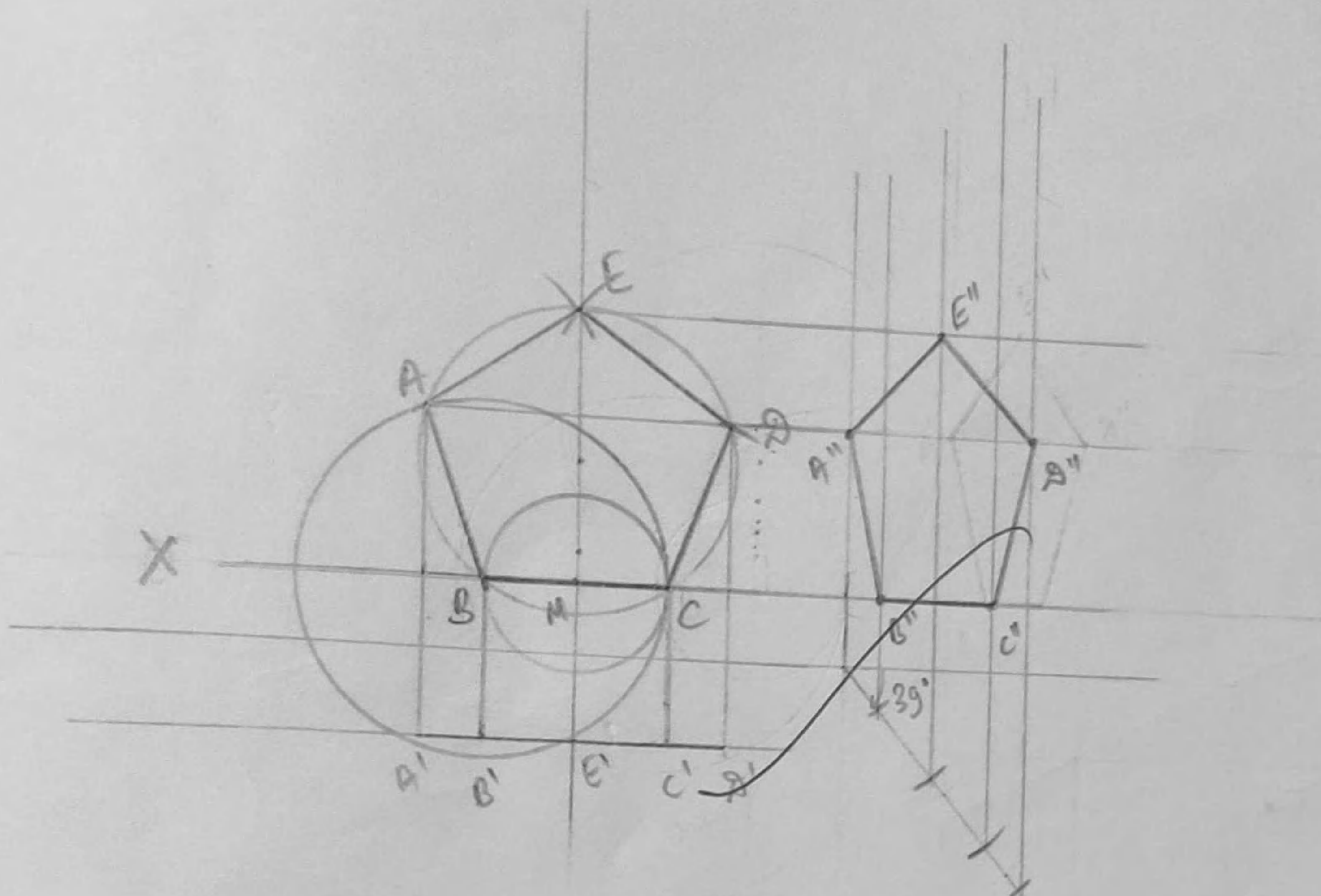

Fig 3.11

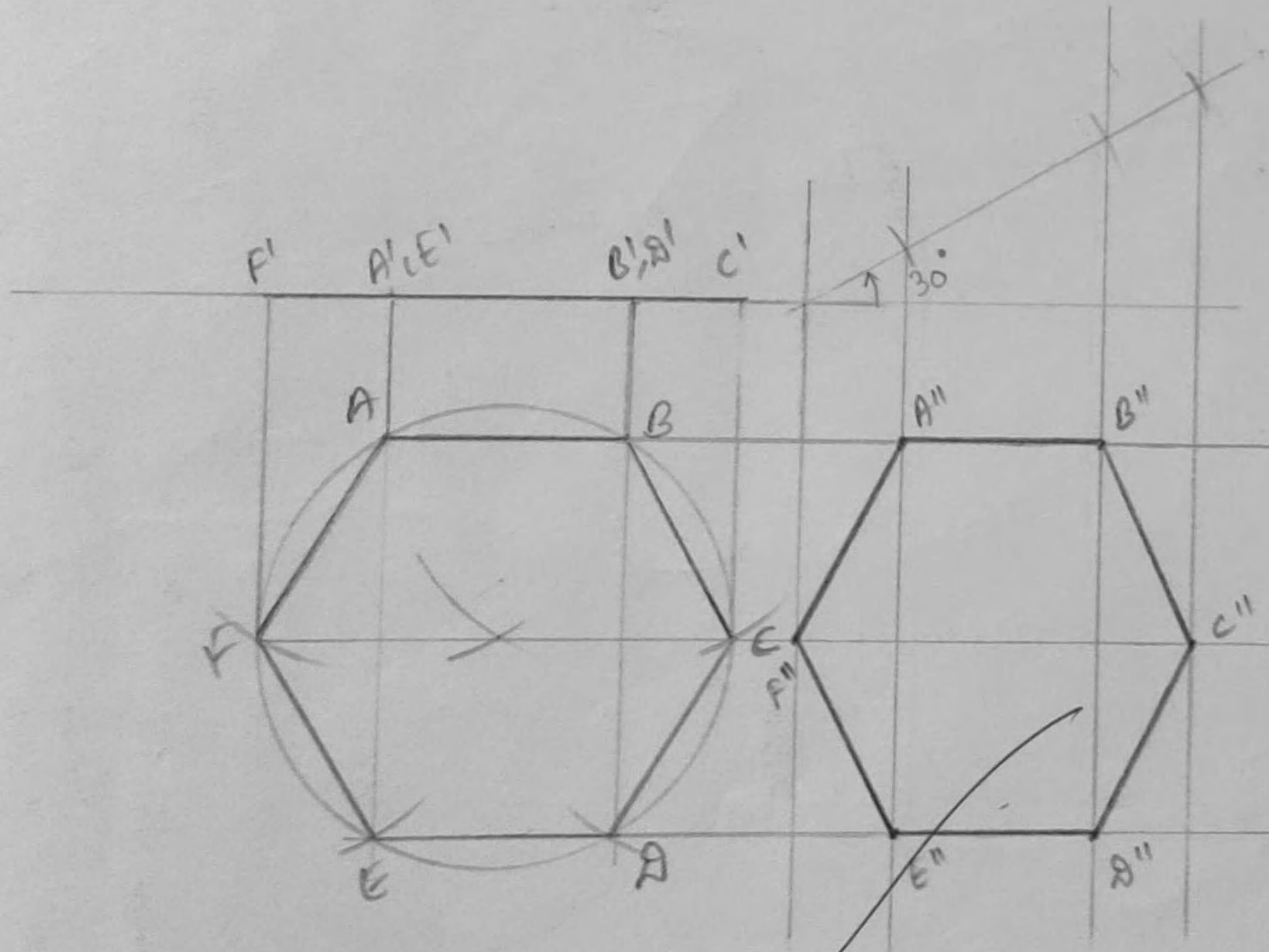

Fig 3.12

45

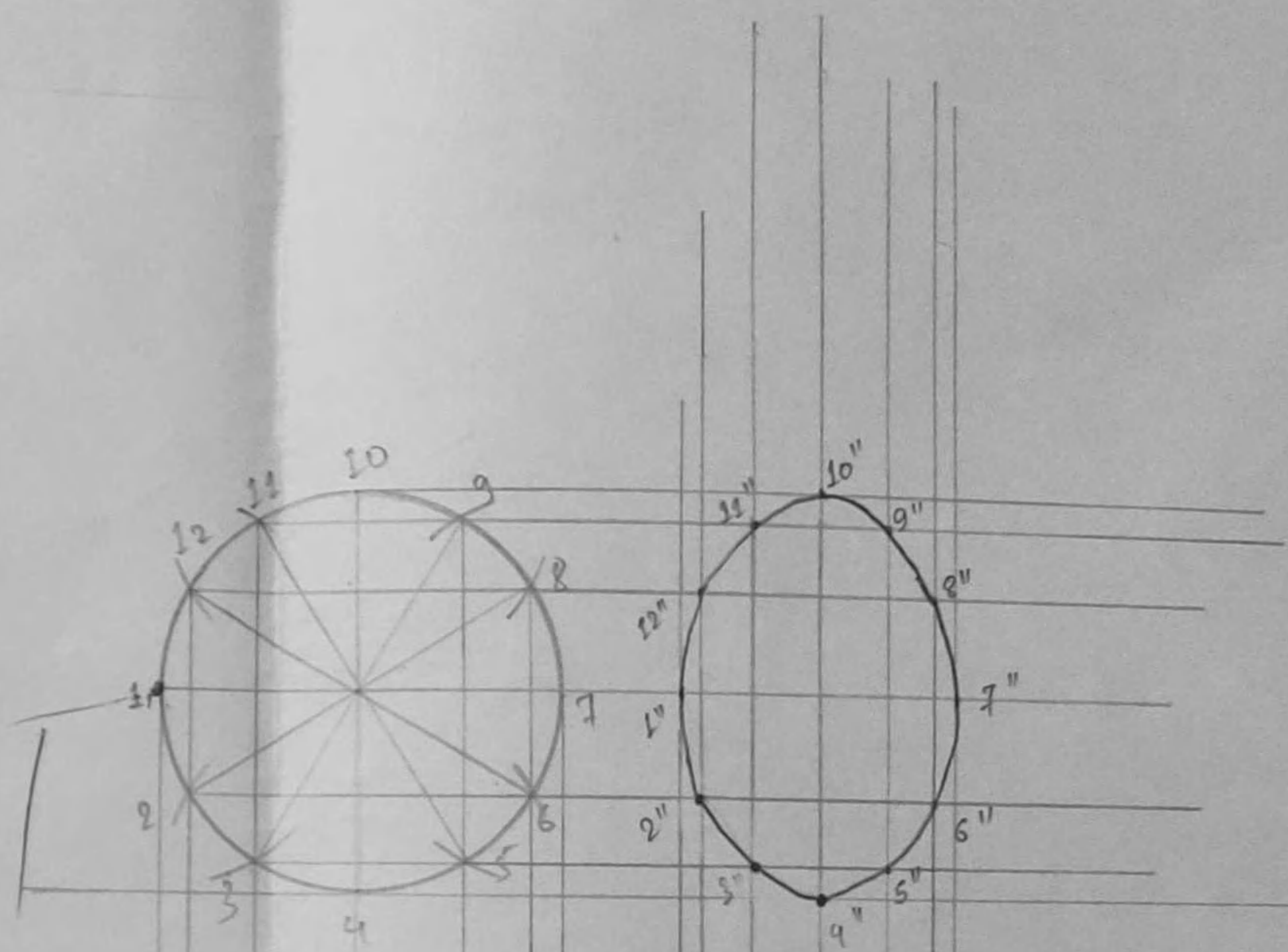
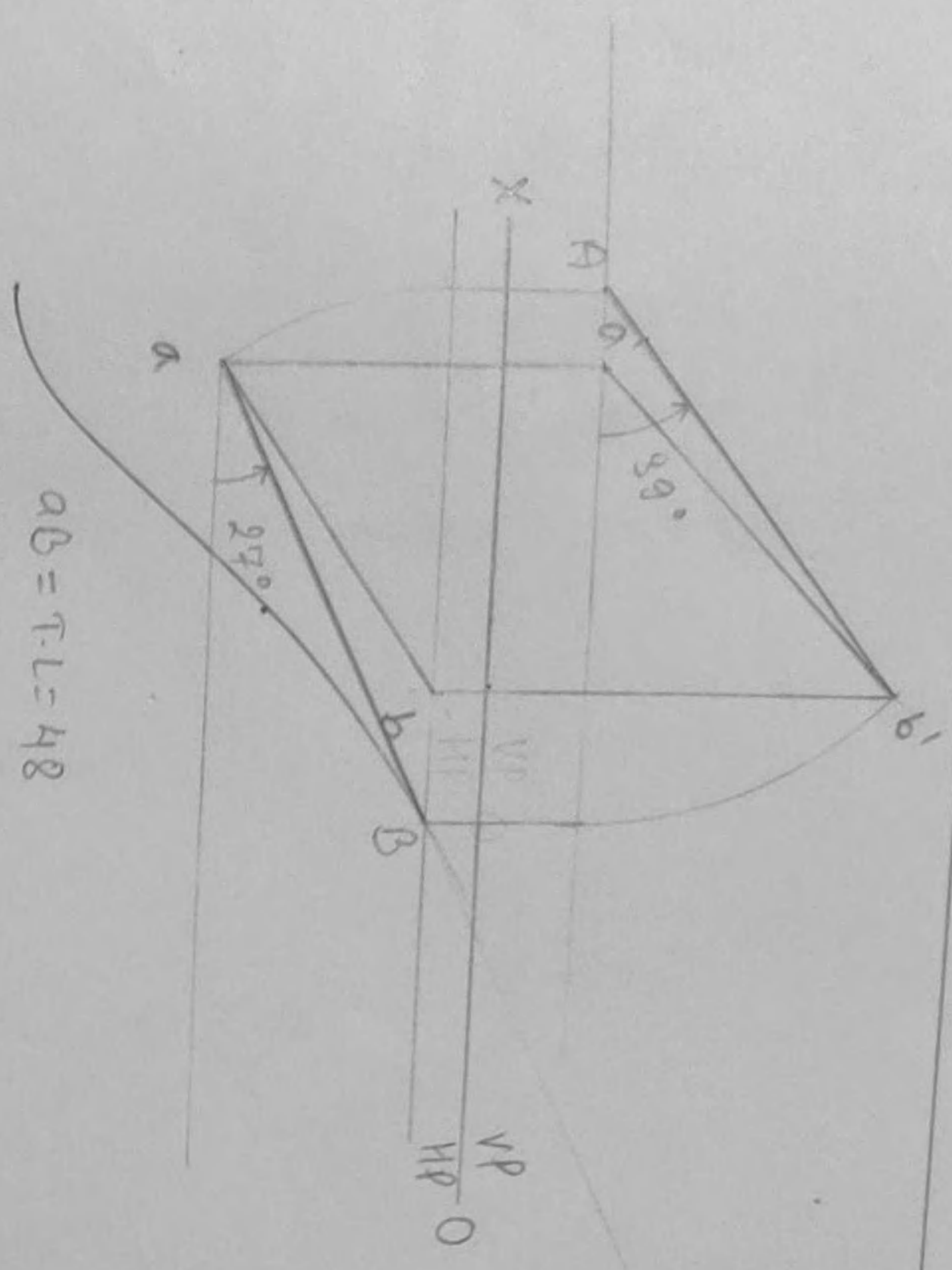
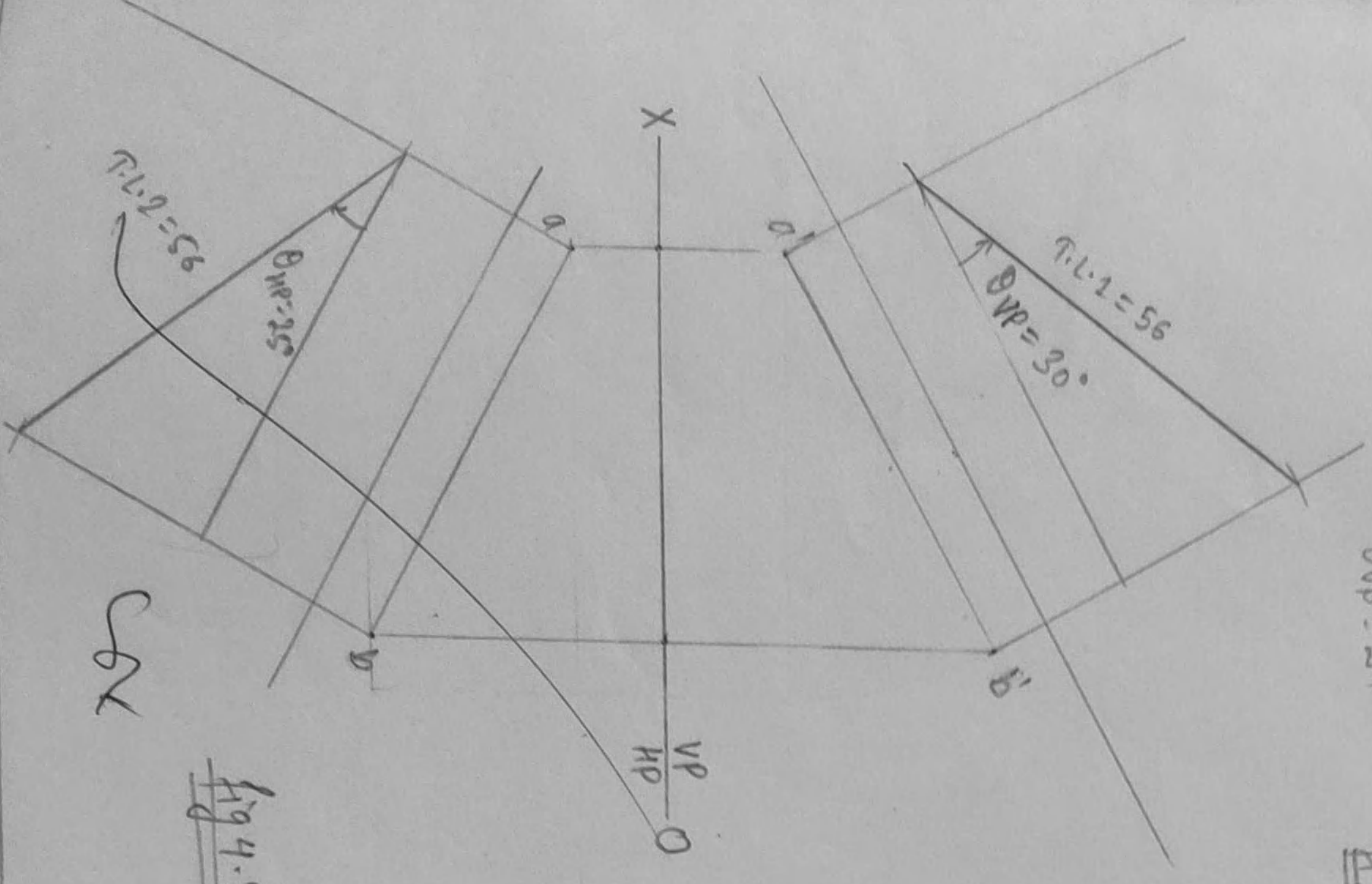

Fig 3.13



$AB = T.L = 48$
 $b'A = T.L = 48$
 $\theta_{HP} = 39^\circ$
 $\theta_{VP} = 27^\circ$

Fig 4.1



$T.L = 56$
 $\theta_{VP} = 30^\circ$
 $\theta_{HP} = 25^\circ$

CON

Fig 4.3

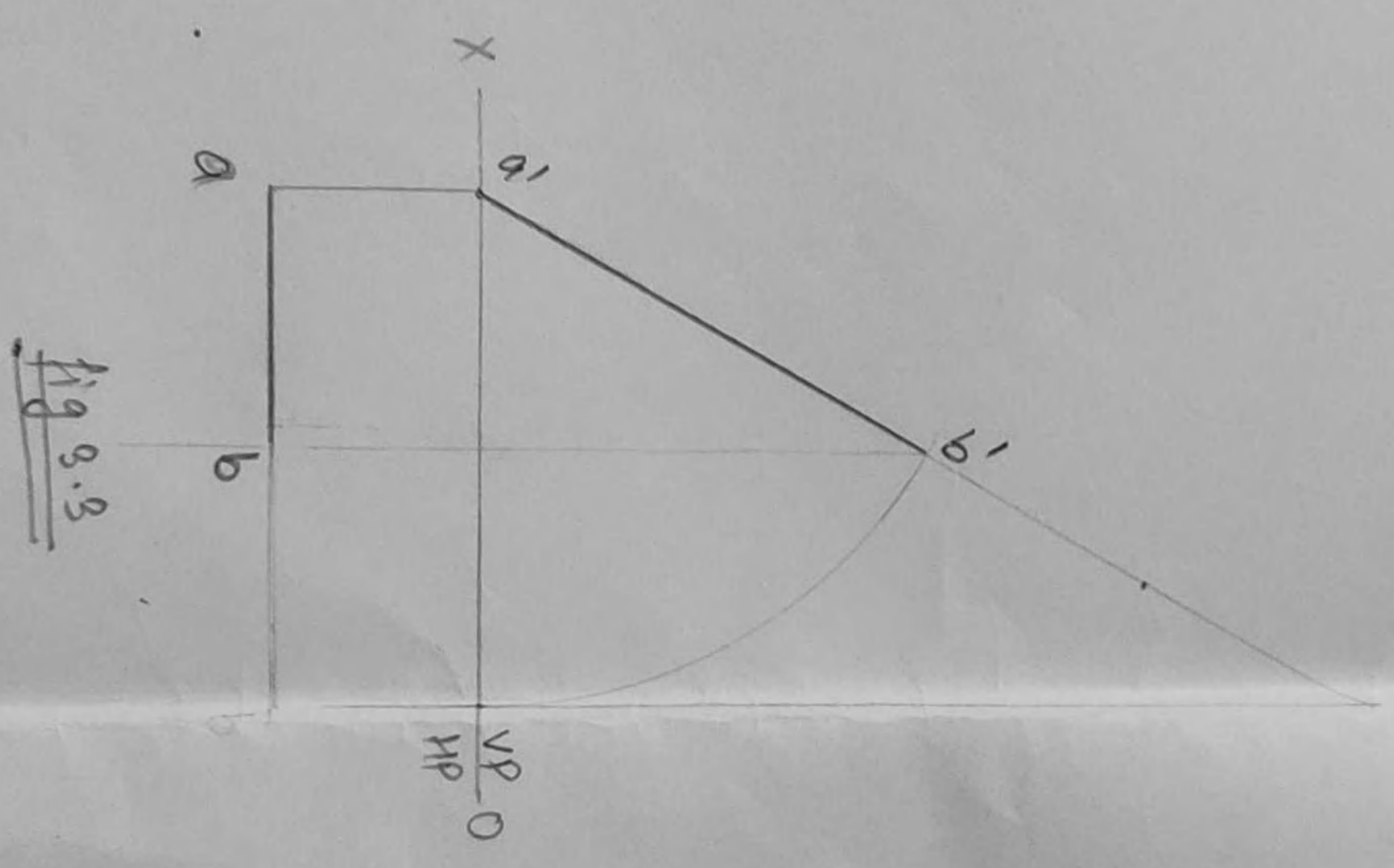
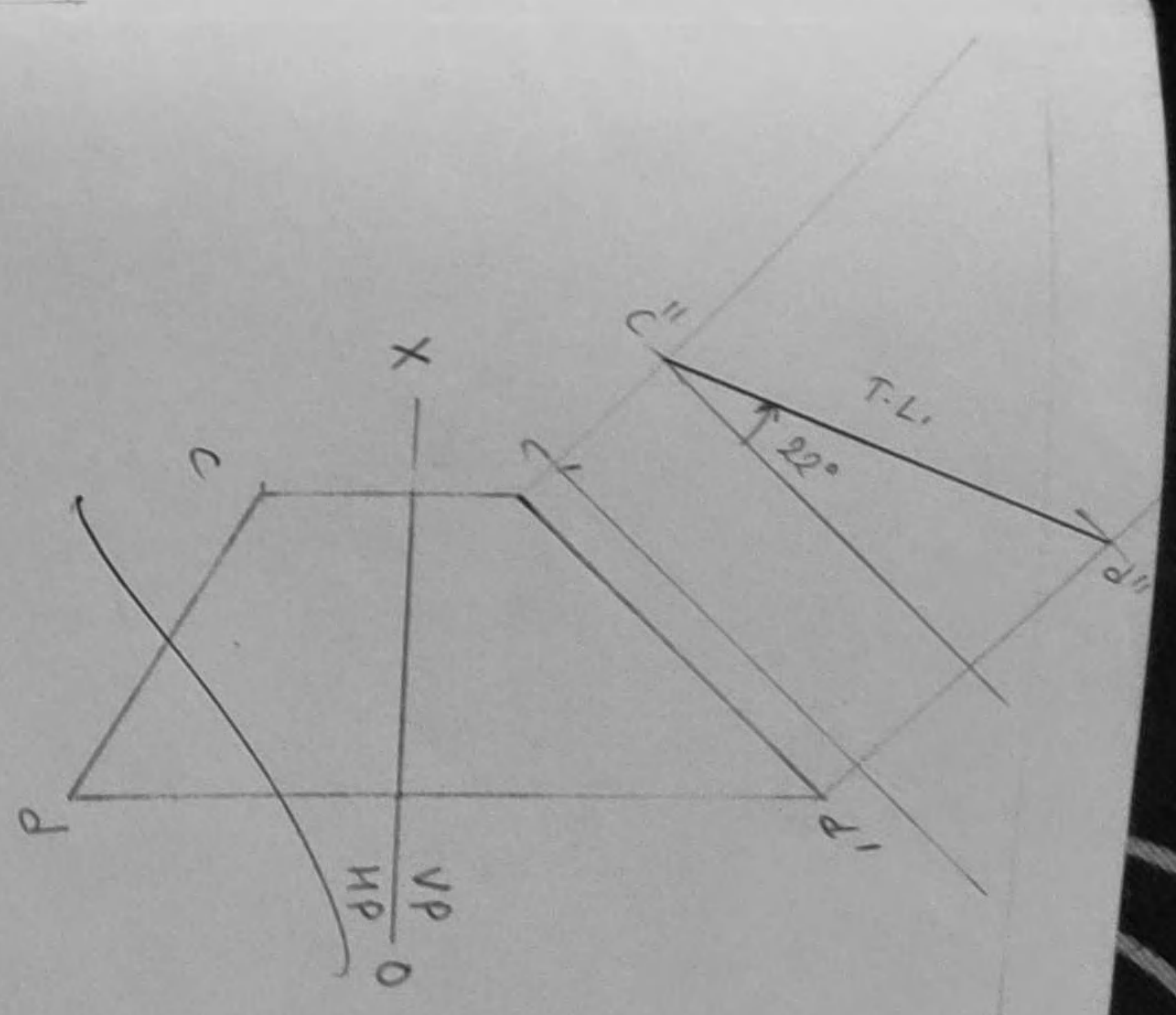

Fig 3.8



$c'd' = T.L = 46$
 $\theta_{VP} = 22^\circ$

Fig 4.2

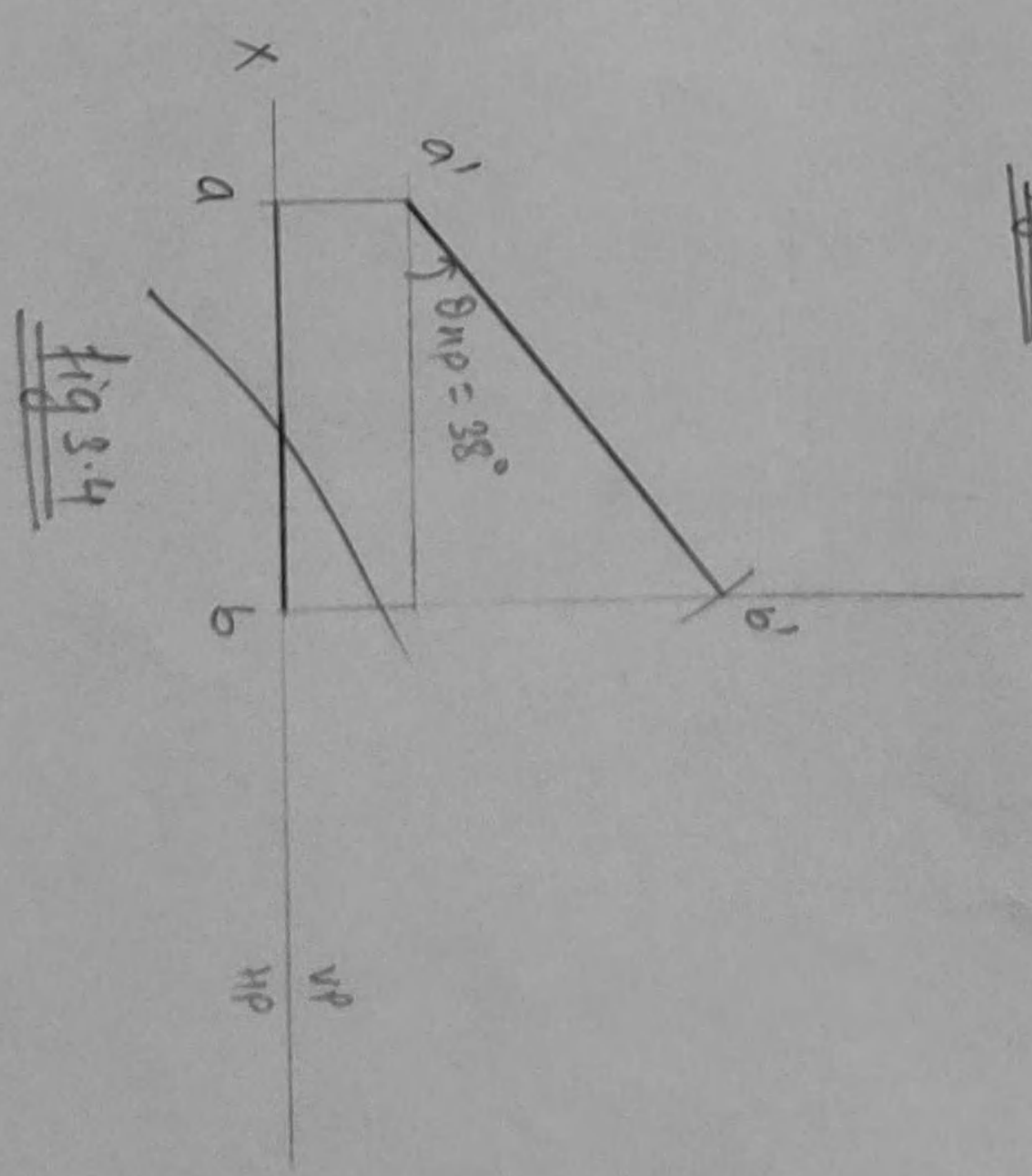
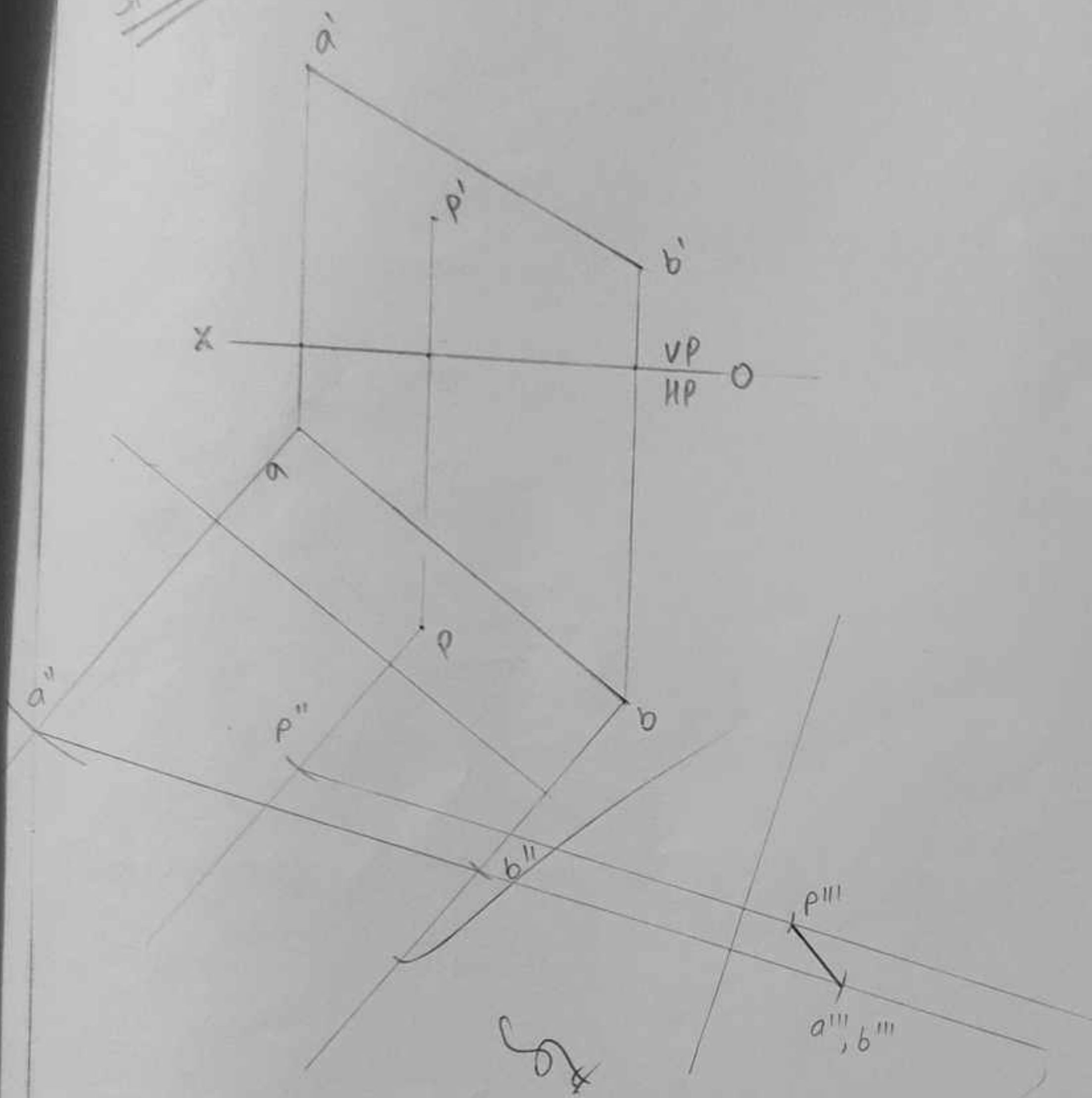

Fig 3.4

SHEET 4



$$P''' a''' = P''' b''' = 12$$

Fig 4.4

Fig 4.5

$a''b'' = 46$
 $a''c'' = 54$
 $c''b'' = 43$



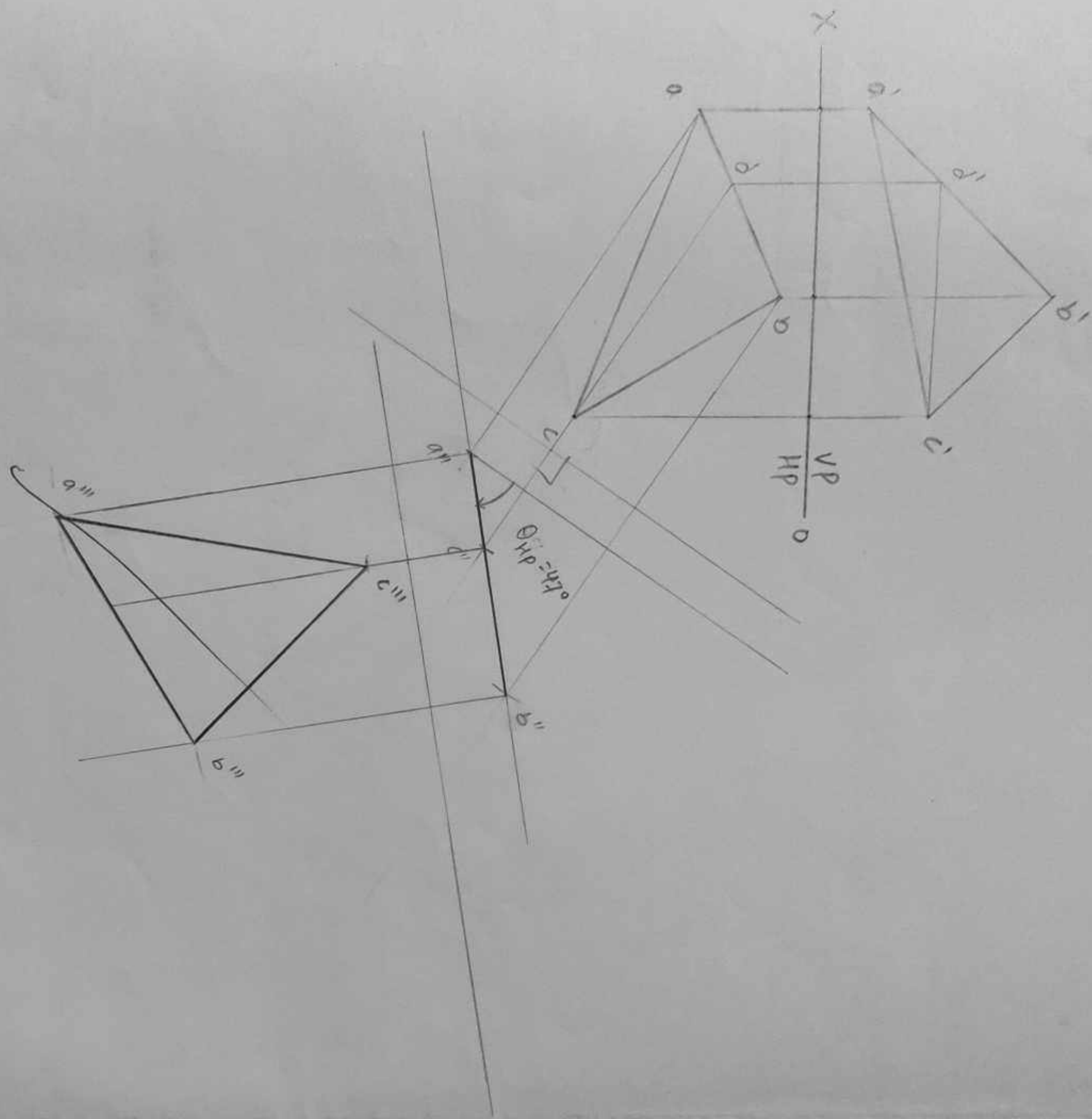

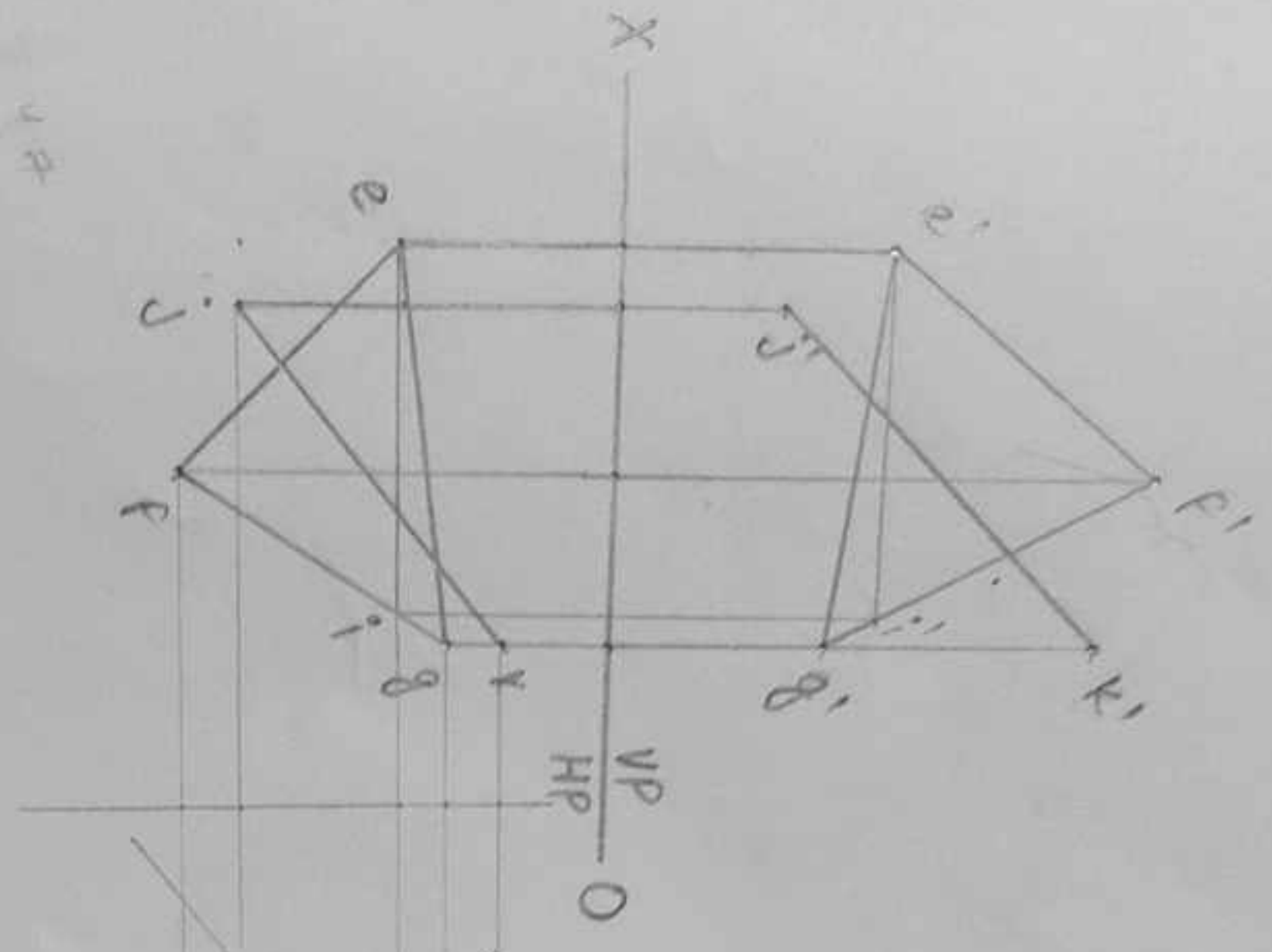
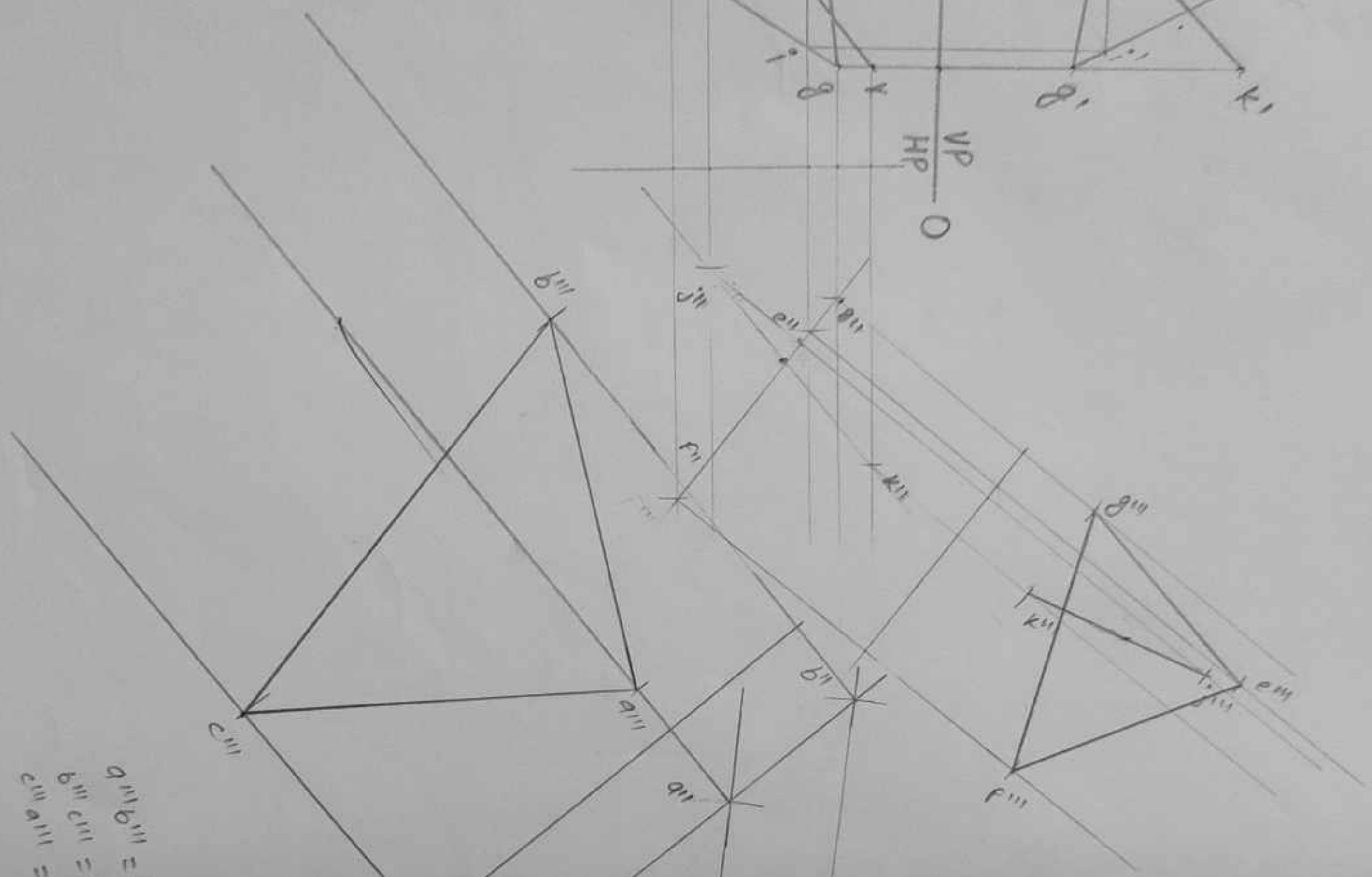

Fig 4.5



$a''b''' = 5d$
 $b''c''' = 5d$
 $c''d''' = 5d$

$\theta_{HP} = 45^\circ$

OX

Fig 4.6

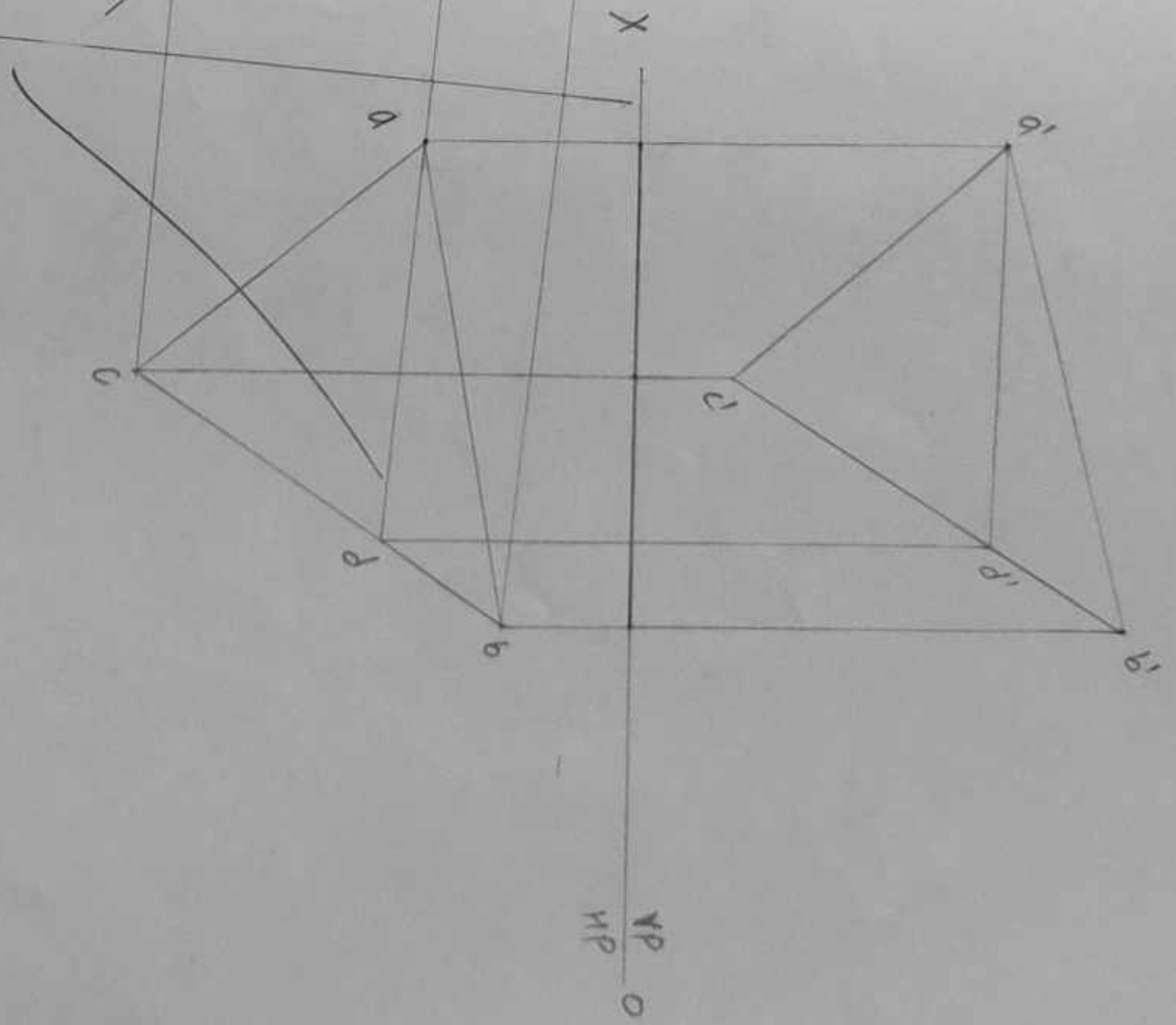

VP
HP
O

Fig 4.9

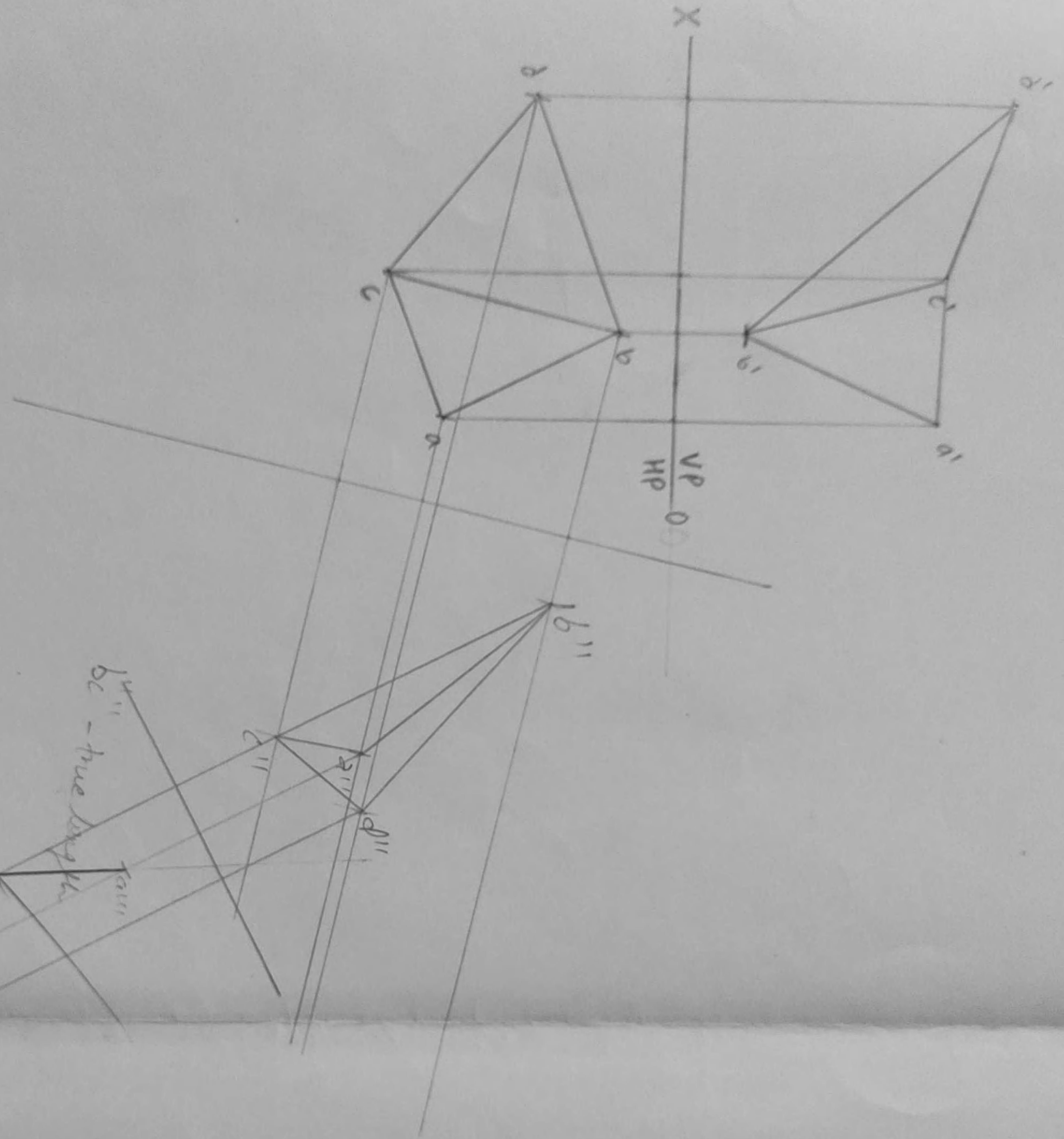

502

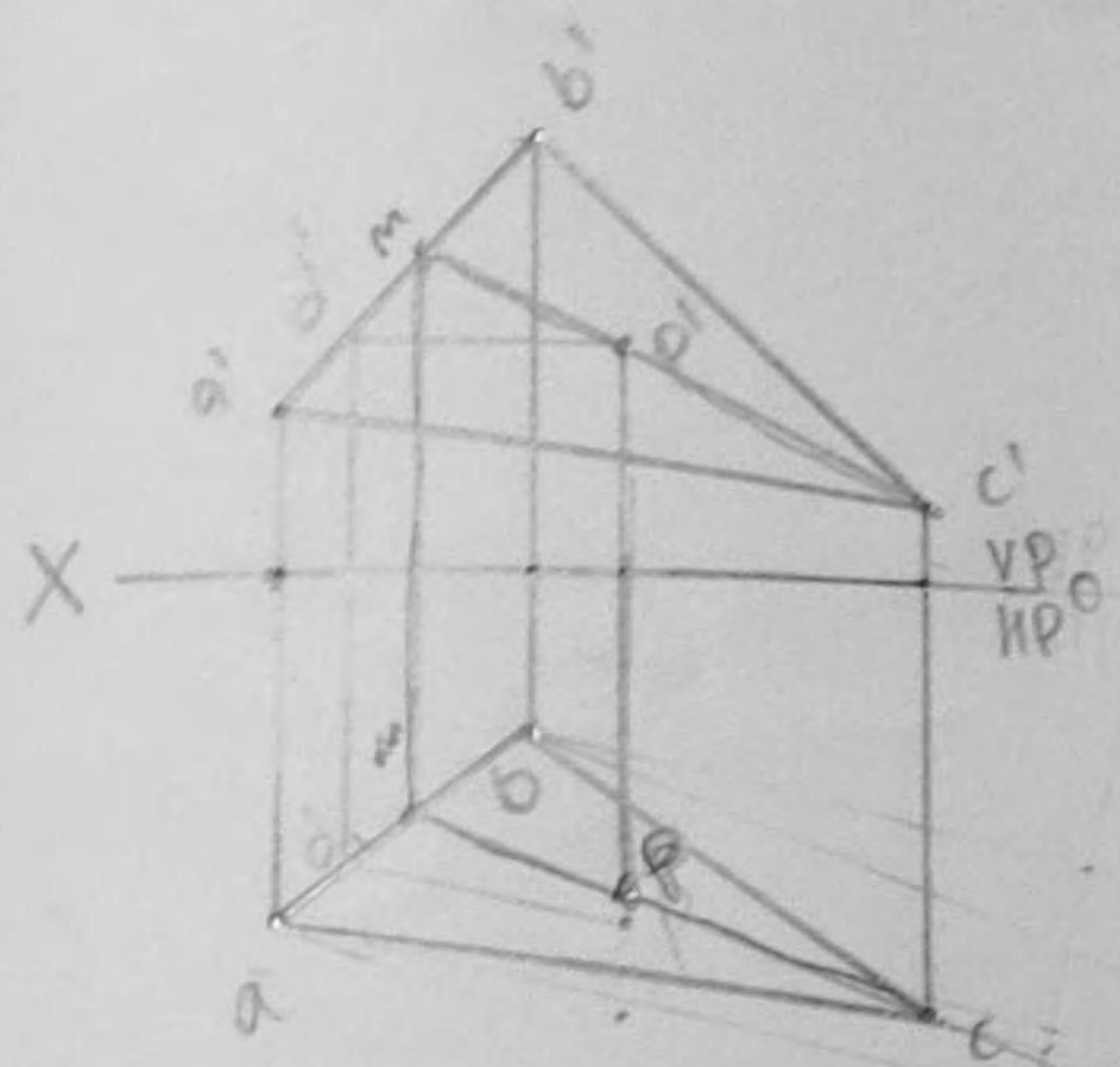

Fig 4.8

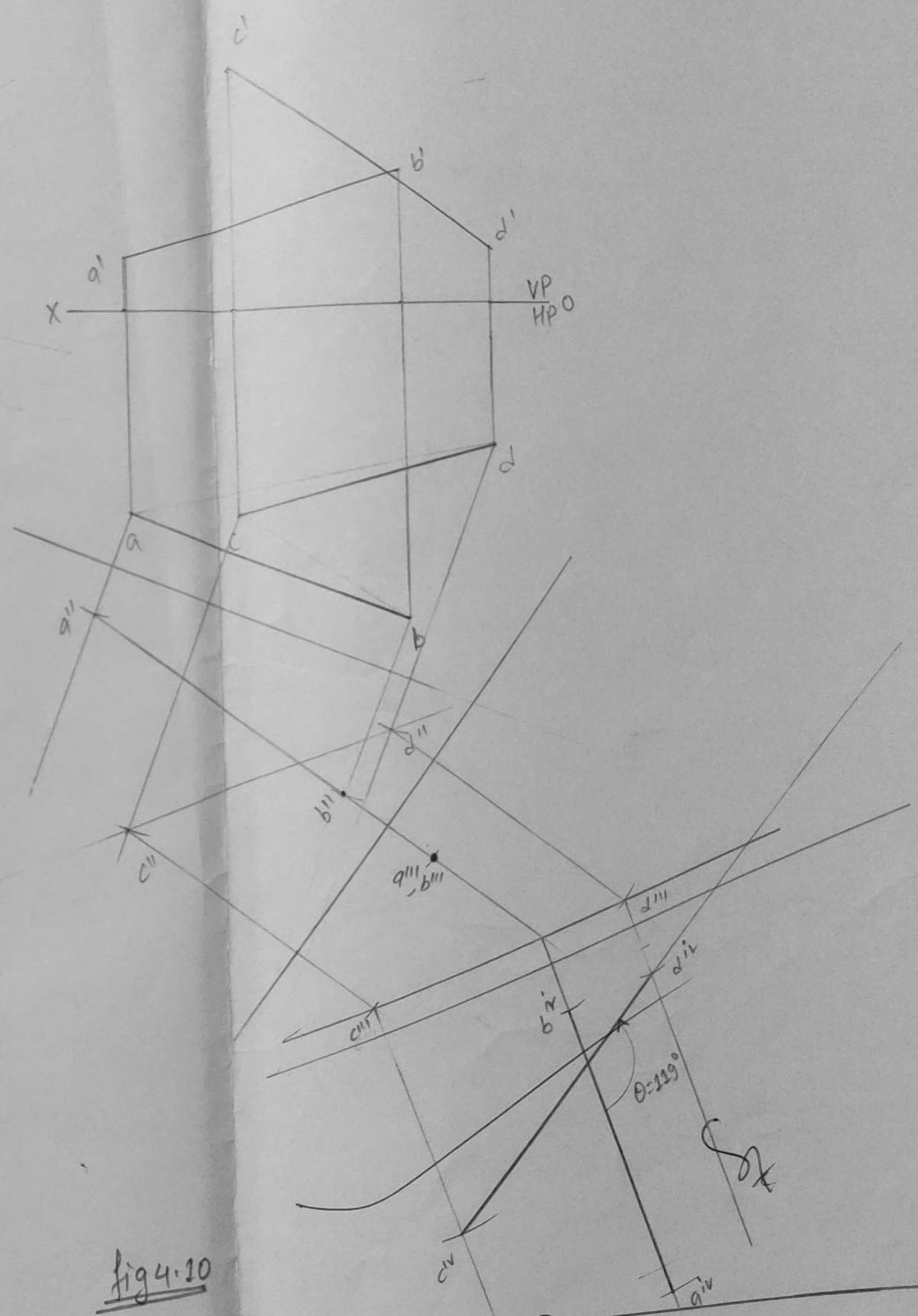

Fig 4.10

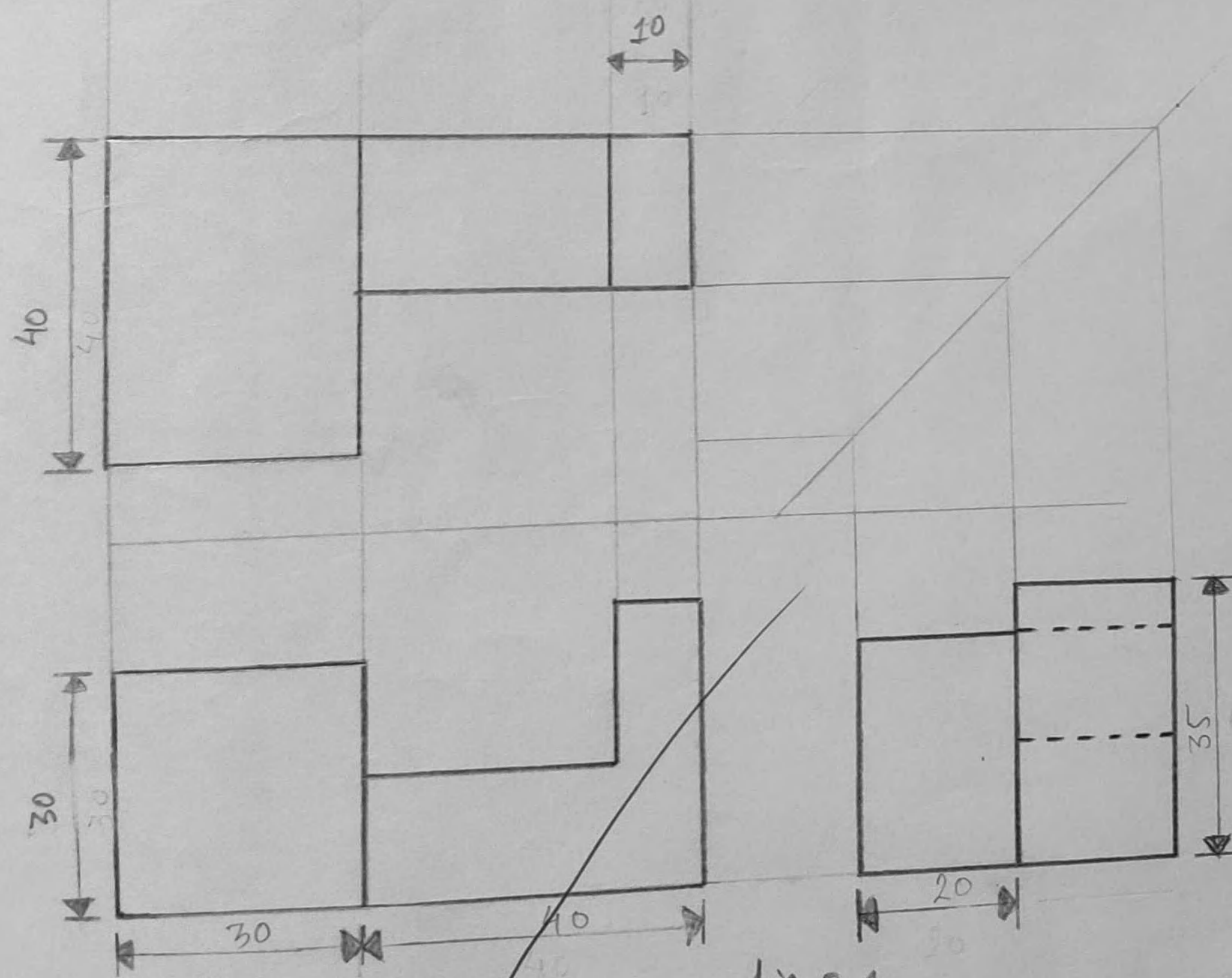

fig 5.1

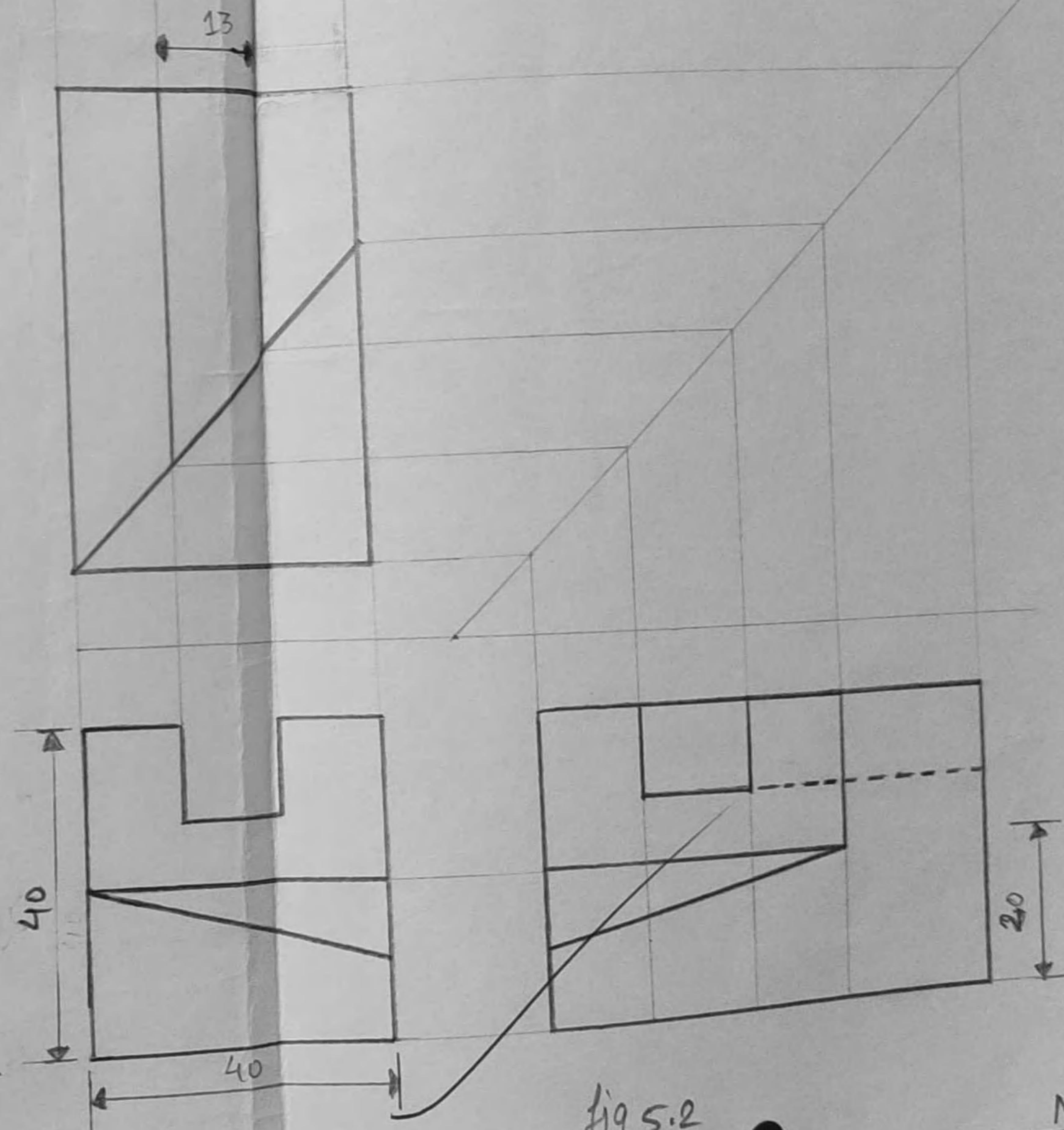

fig 5.2

Fig

Name :- Krishan Murari Arya
Rollno :- 1009

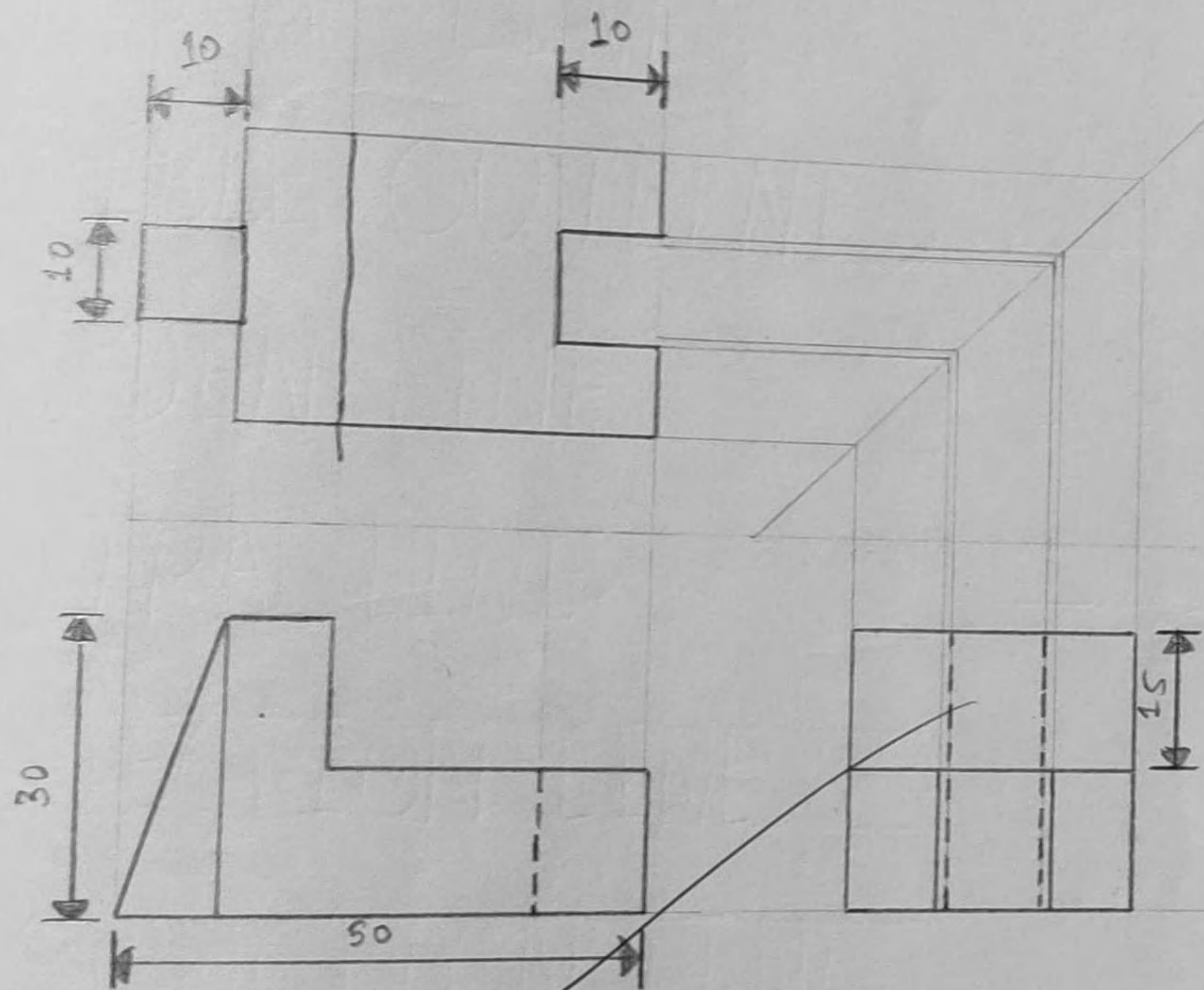

Fig 5.3

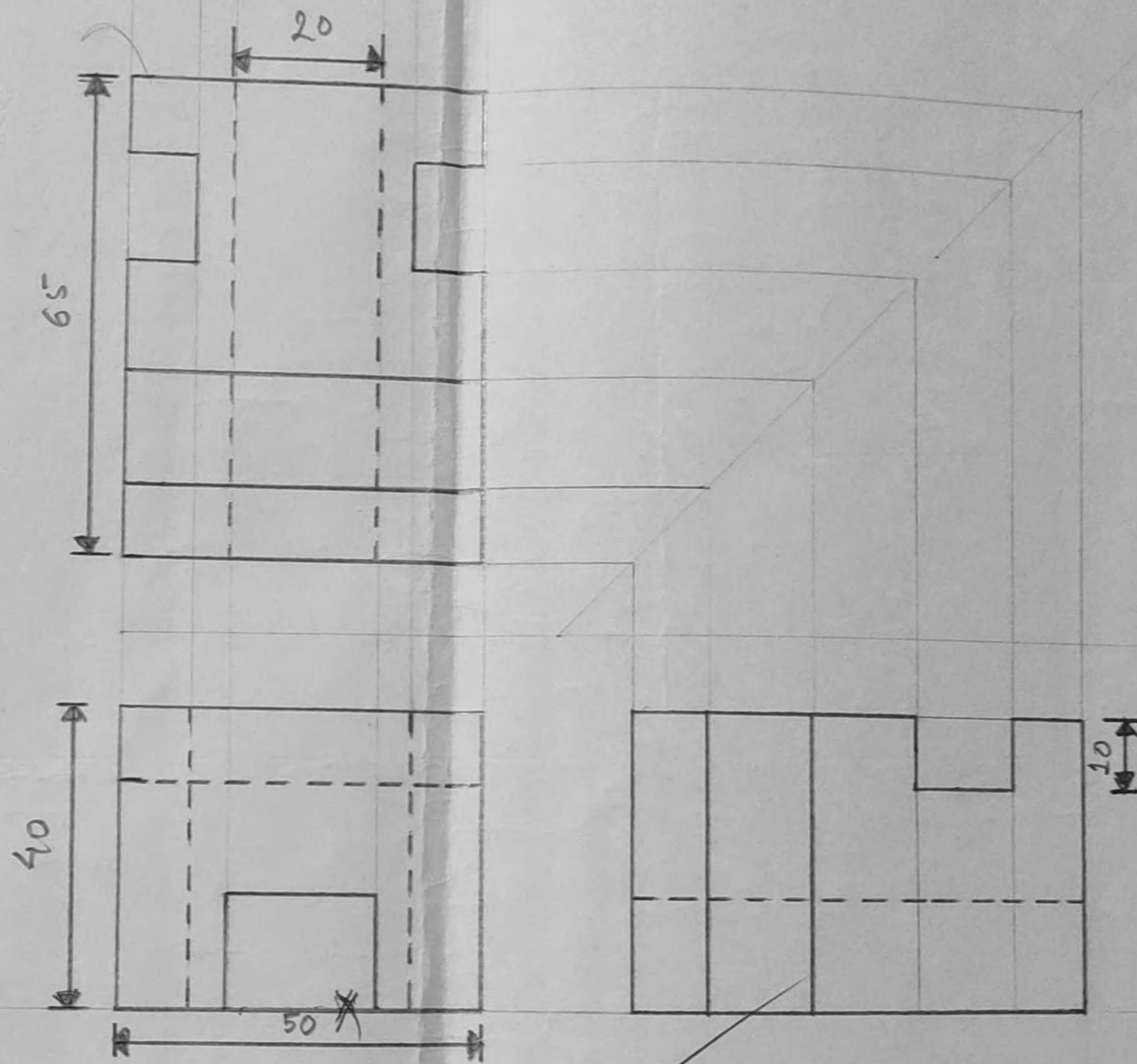

Fig 5.4

S.N.	DESCRIPTION	QTY.	MATERIAL	REMARK
DRAWN BY	KRISHNA MURARI ARYAL		NCE	
ROLL NO	009			
CHKD BY	<i>[Signature]</i>			
TITLE				
SCALE	1:1		DRG. SHEET NO.:	3
DATE	20/5/08/15			
METRIC SYSTEM				

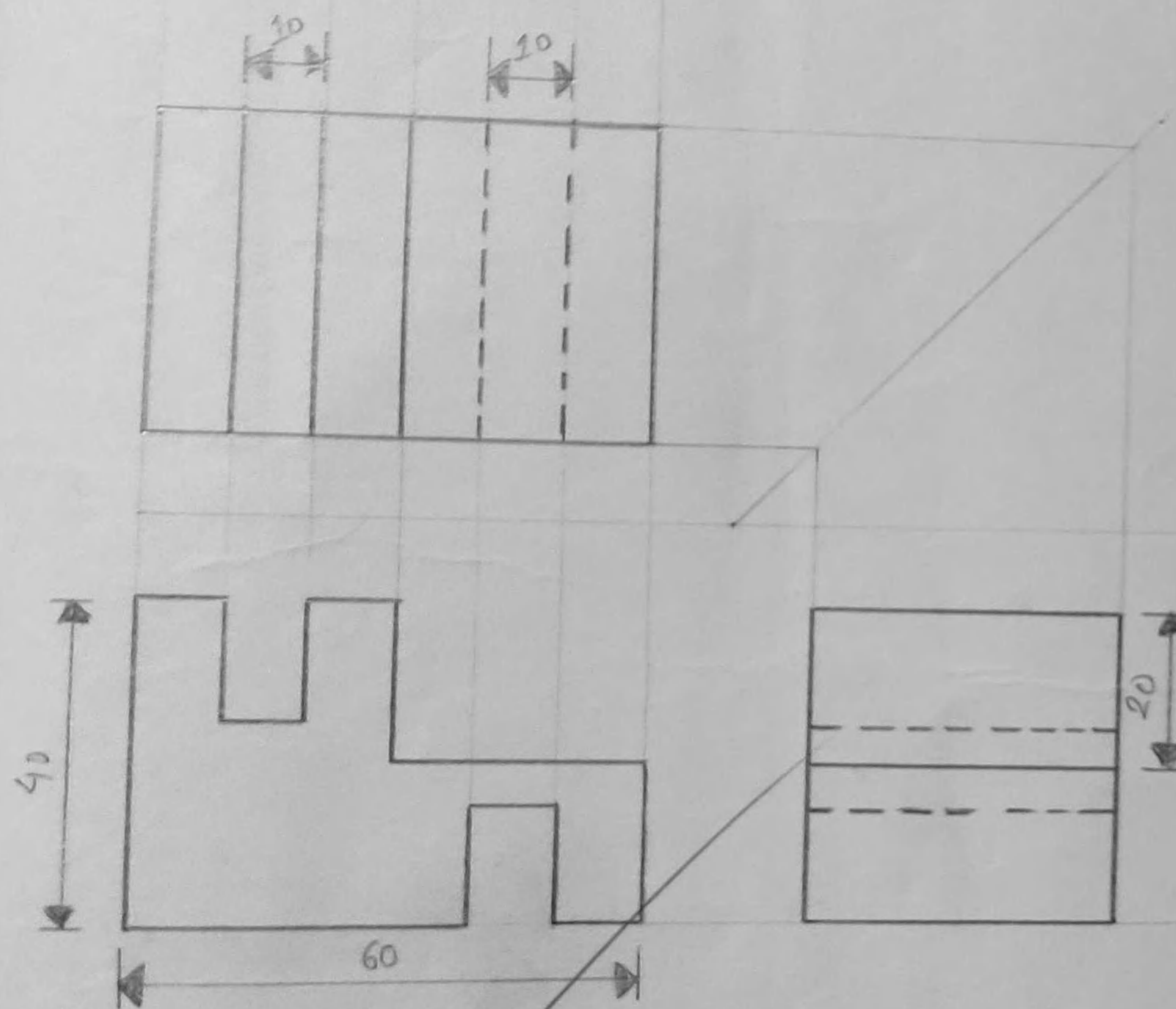

Fig 5.5

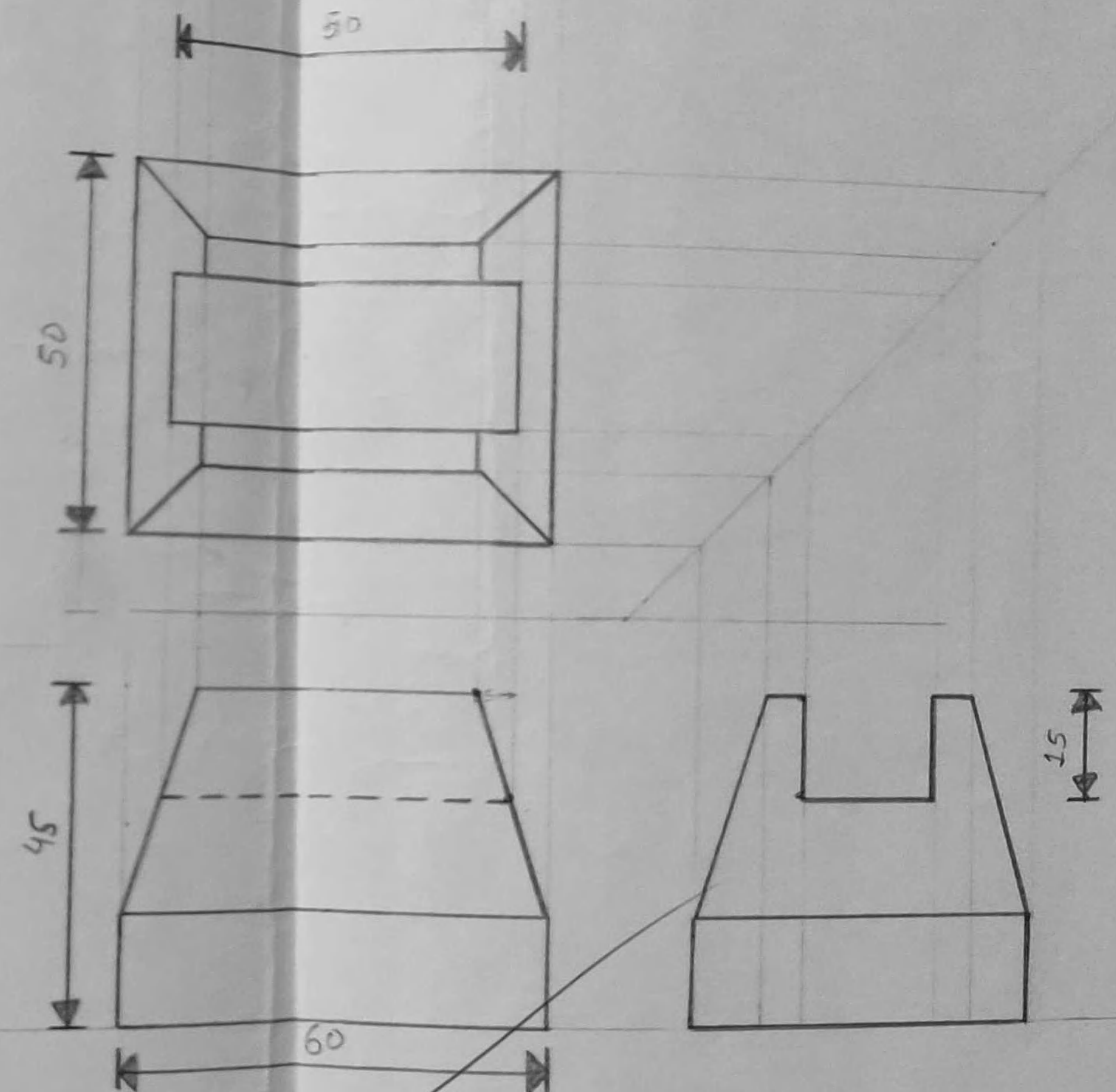

Fig 5.6

S.N.	DESCRIPTION	QTY.	MATERIAL	REMARK
DRAWN BY	KRISHNA MURARI ARYAL			
ROLL NO	009		NCE	
CHKD BY				
TITLE				
SCALE	1:1			
DATE	20/5/1081/15			
	METRIC SYSTEM			
				DRG. SHEET NO. 4

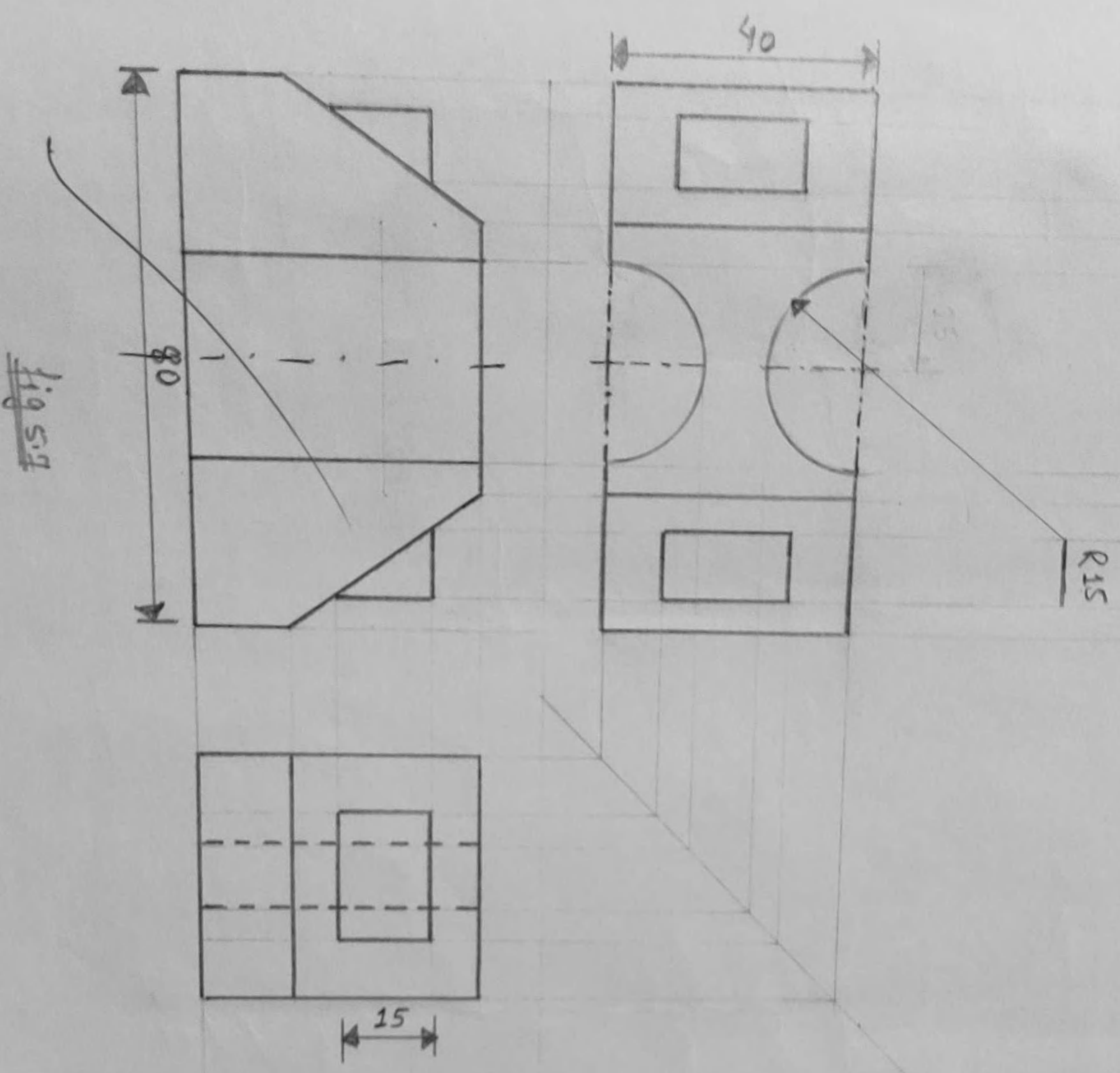

Fig 5.9

S.N.	DESCRIPTION	QTY	MATERIAL	REMARK
DRAWN BY				
ROLL NO				
CHKD BY				
TITLE				
SCALE	1:1			DRG. SHEET NO: 5
DATE	2015/08/15			
	METRIC SYSTEM			

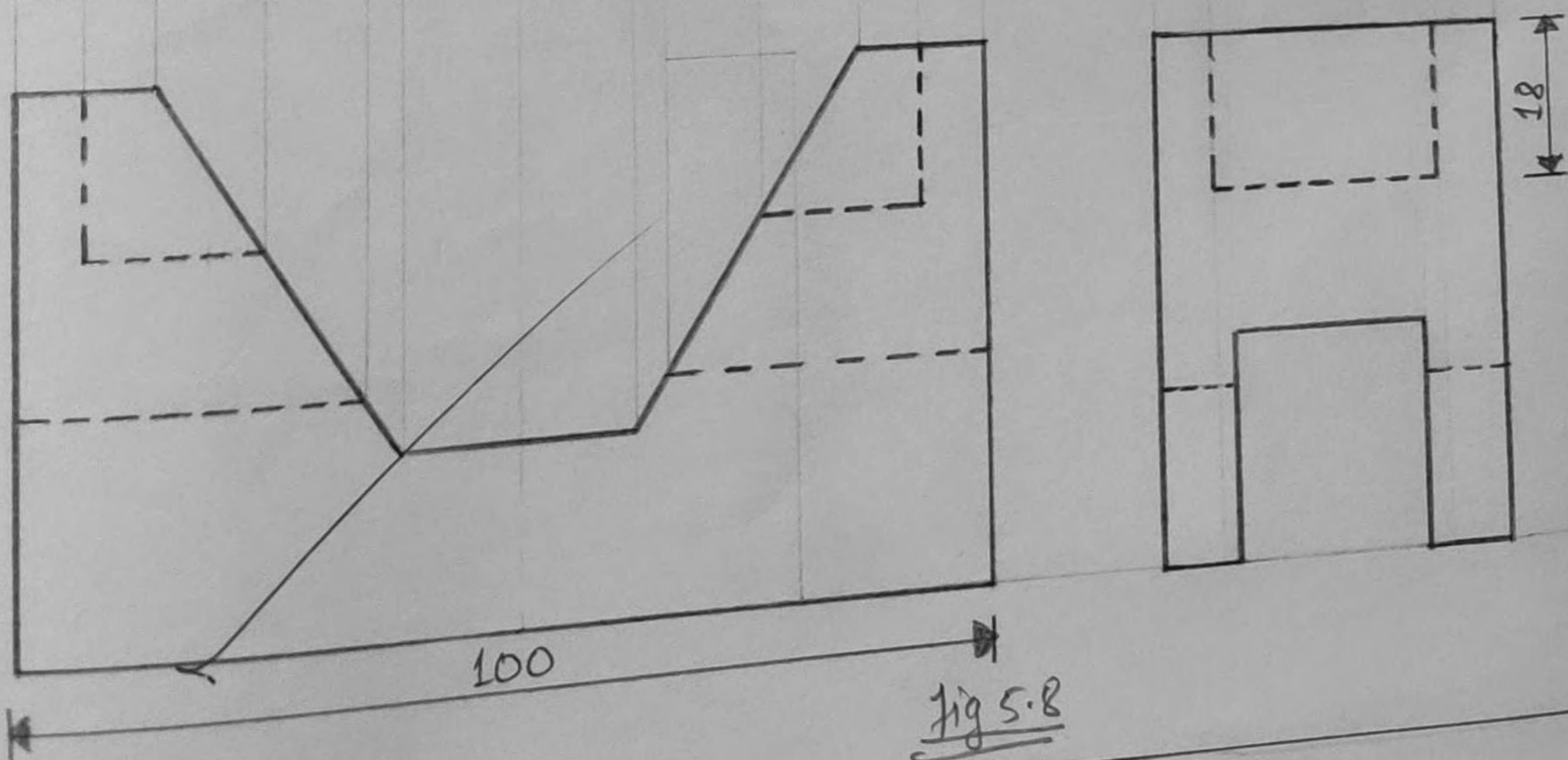
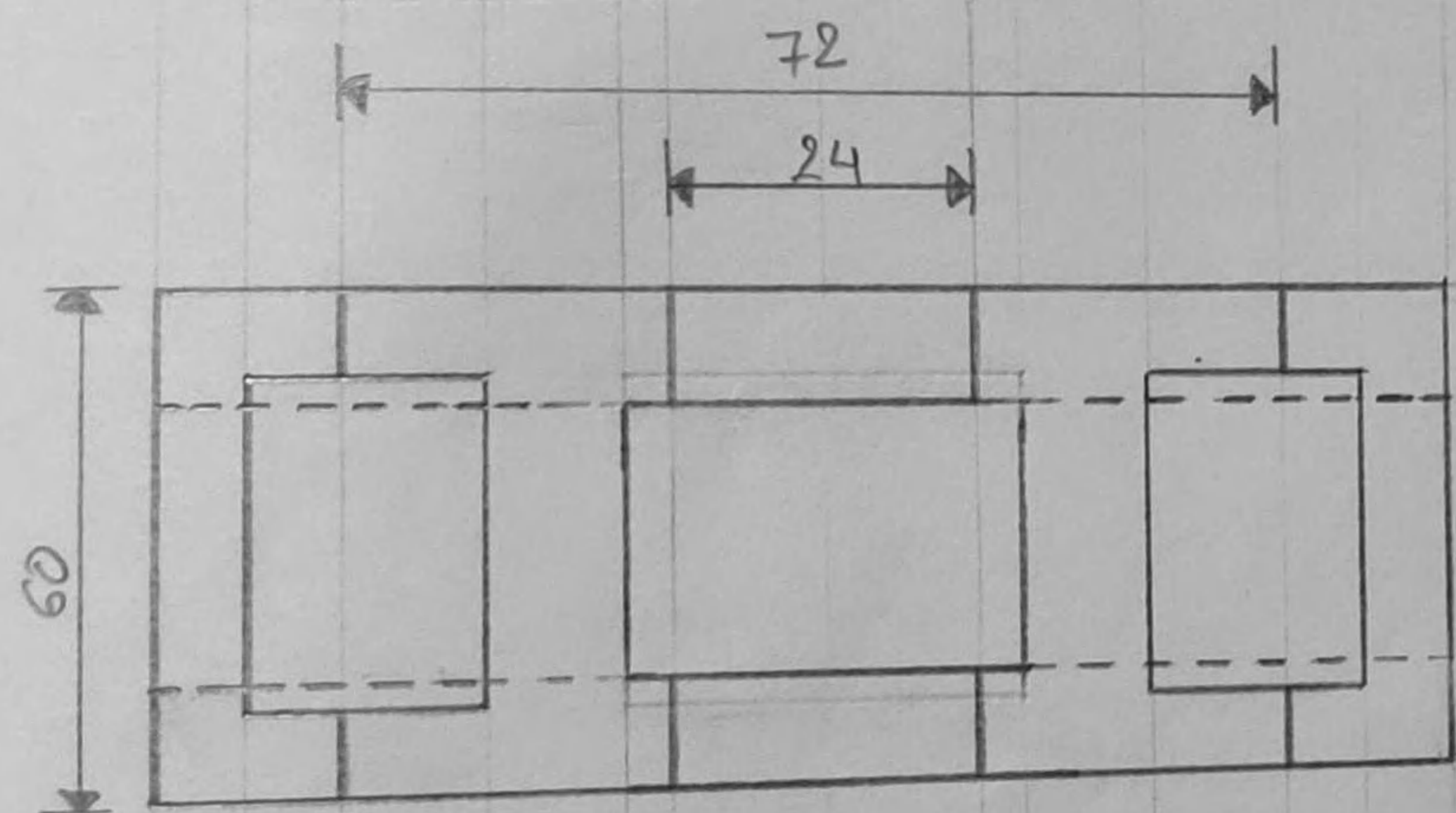
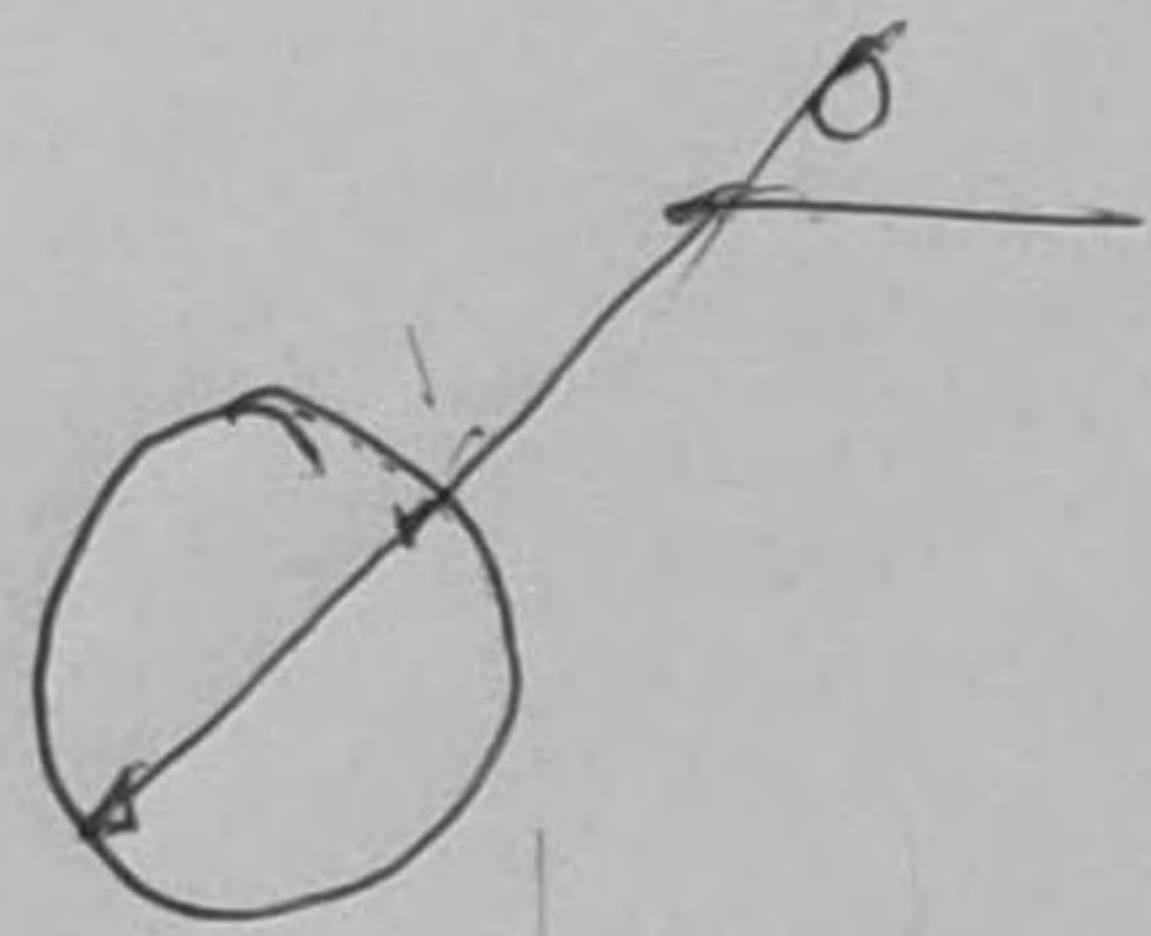

Fig 5.8

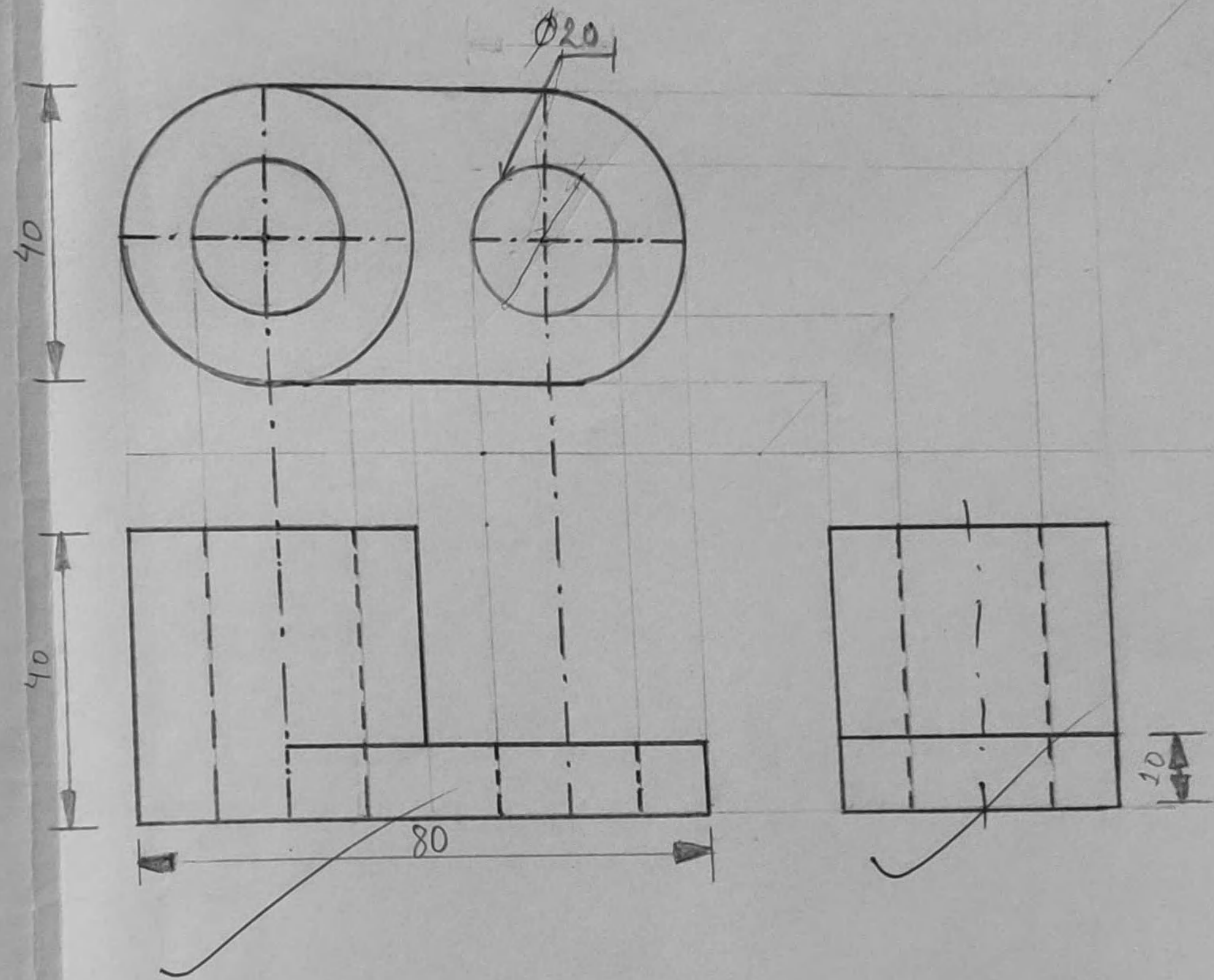

Fig 5.9

S.N.	DESCRIPTION	QTY	MATERIAL	REMARK
DRAWN BY	KRISHNA MURARI ARYAL			NCE
ROLL NO	009			
CHKD BY	<i>[Signature]</i>			
TITLE				
SCALE	1:1			
DATE	2025/08/22			
	METRIC SYSTEM			
			DRG SHEET NO: 6	

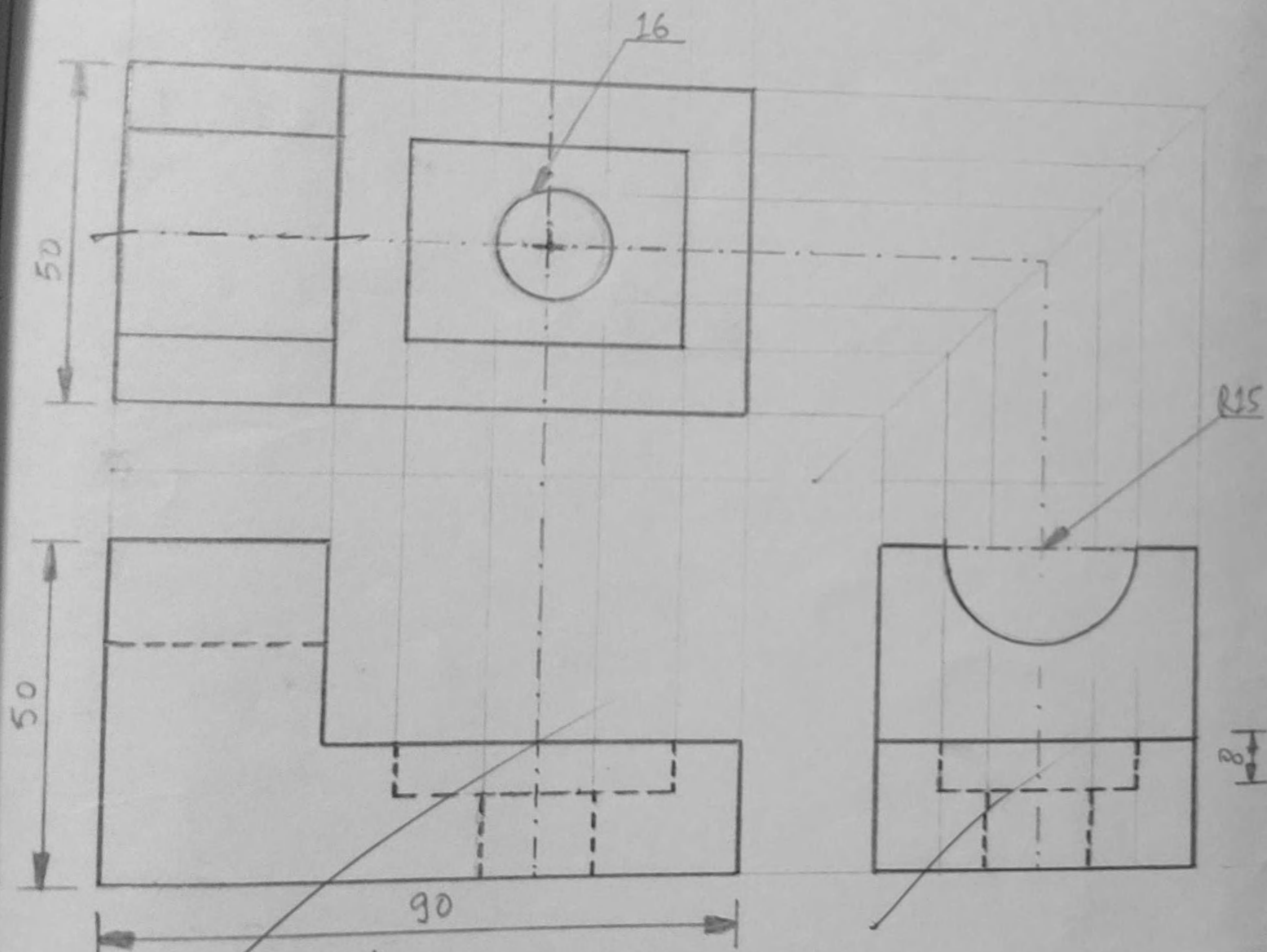

Fig 5.10

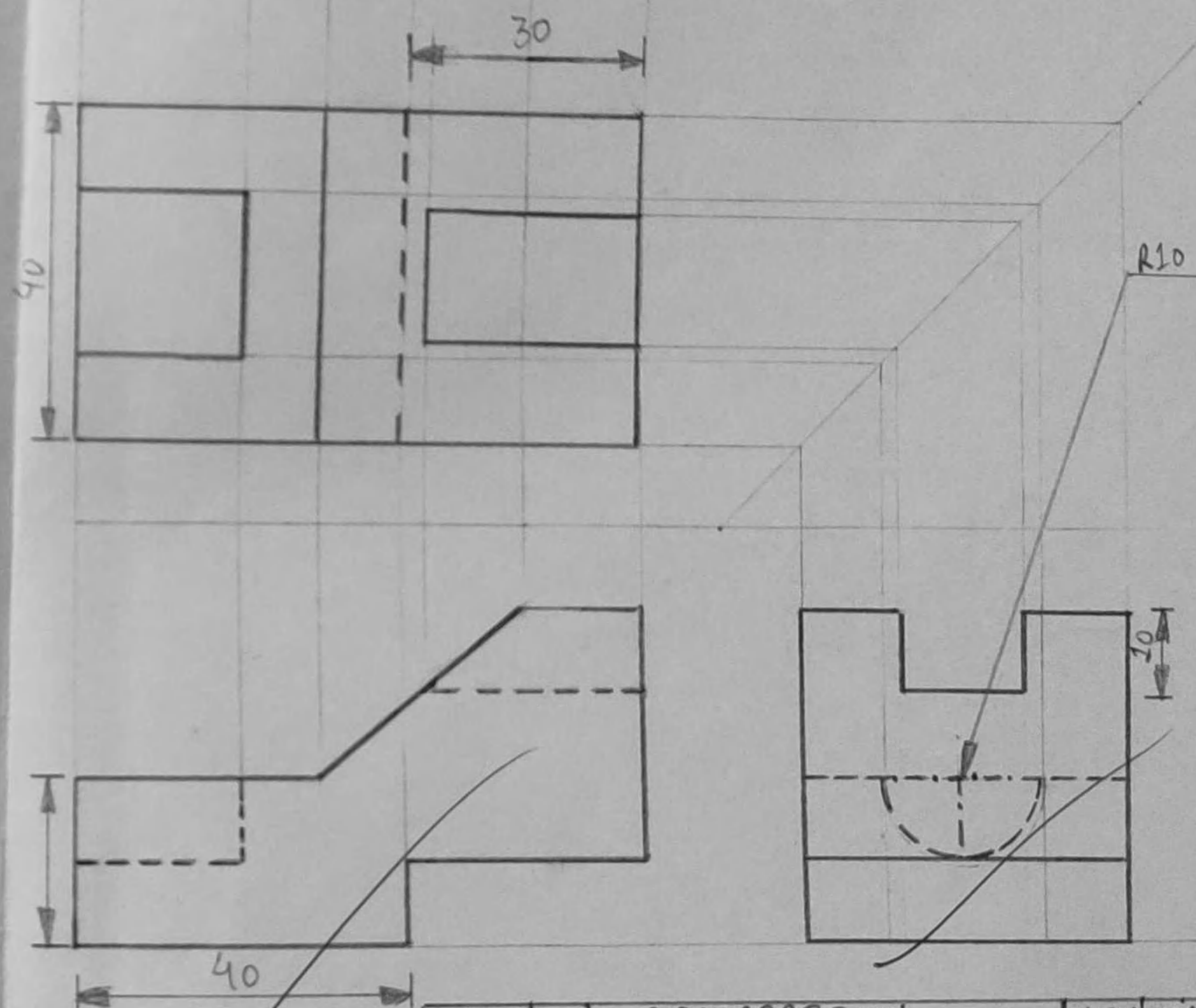

Fig 5.12

S.N	DESCRIPTION	QTY	MATERIAL	REMARK
DRAWN BY	KRISHNA MURARI ARYAL.			
ROLL NO	009.			NCE
CHKD BY	<i>[Signature]</i>			
TITLE				
SCALE	1:1			DRG. SHEET NO → 7
DATE	20/5/08/22			
	METRIC SYSTEM			

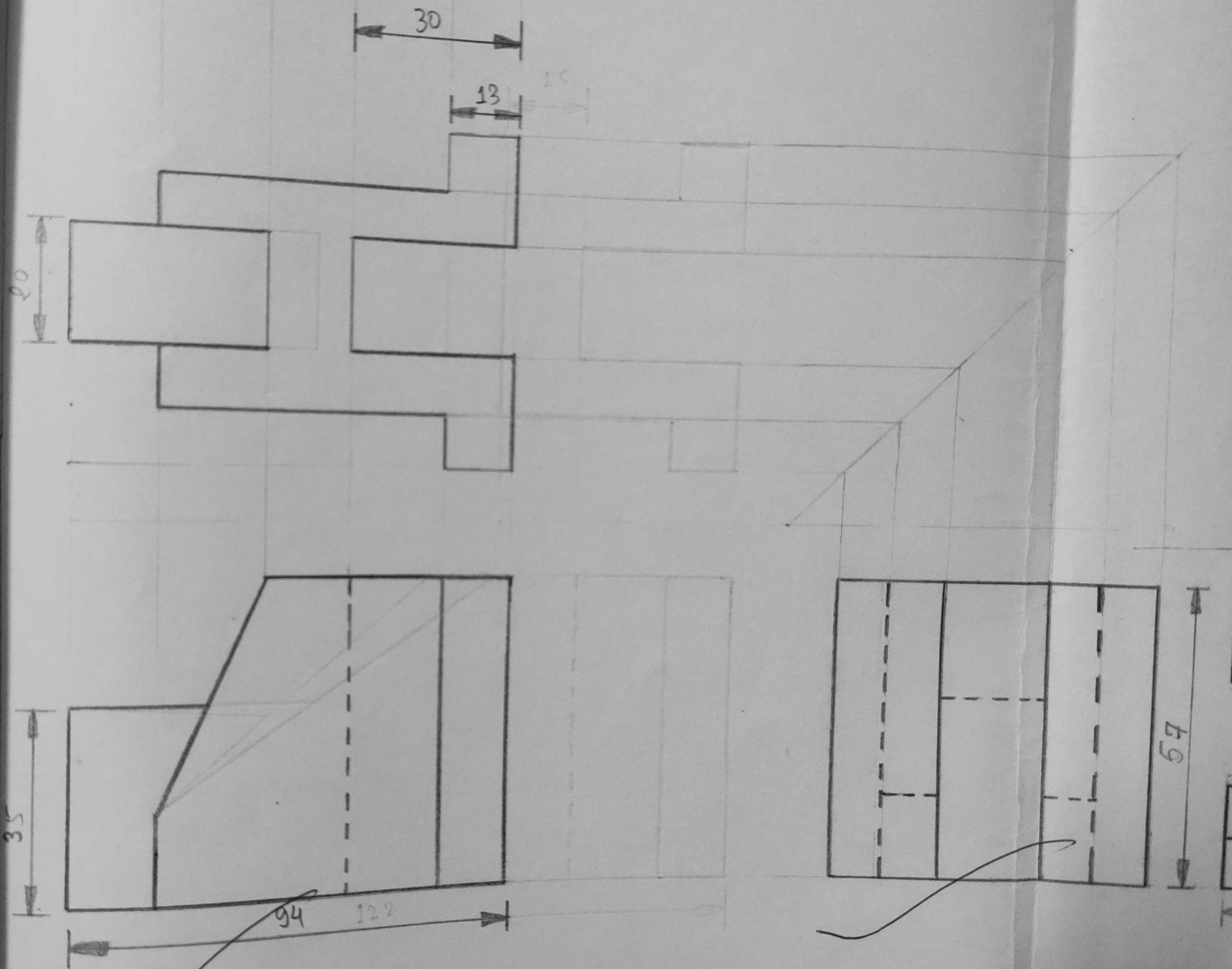

Fig 5.11

SHEET 5 REV.

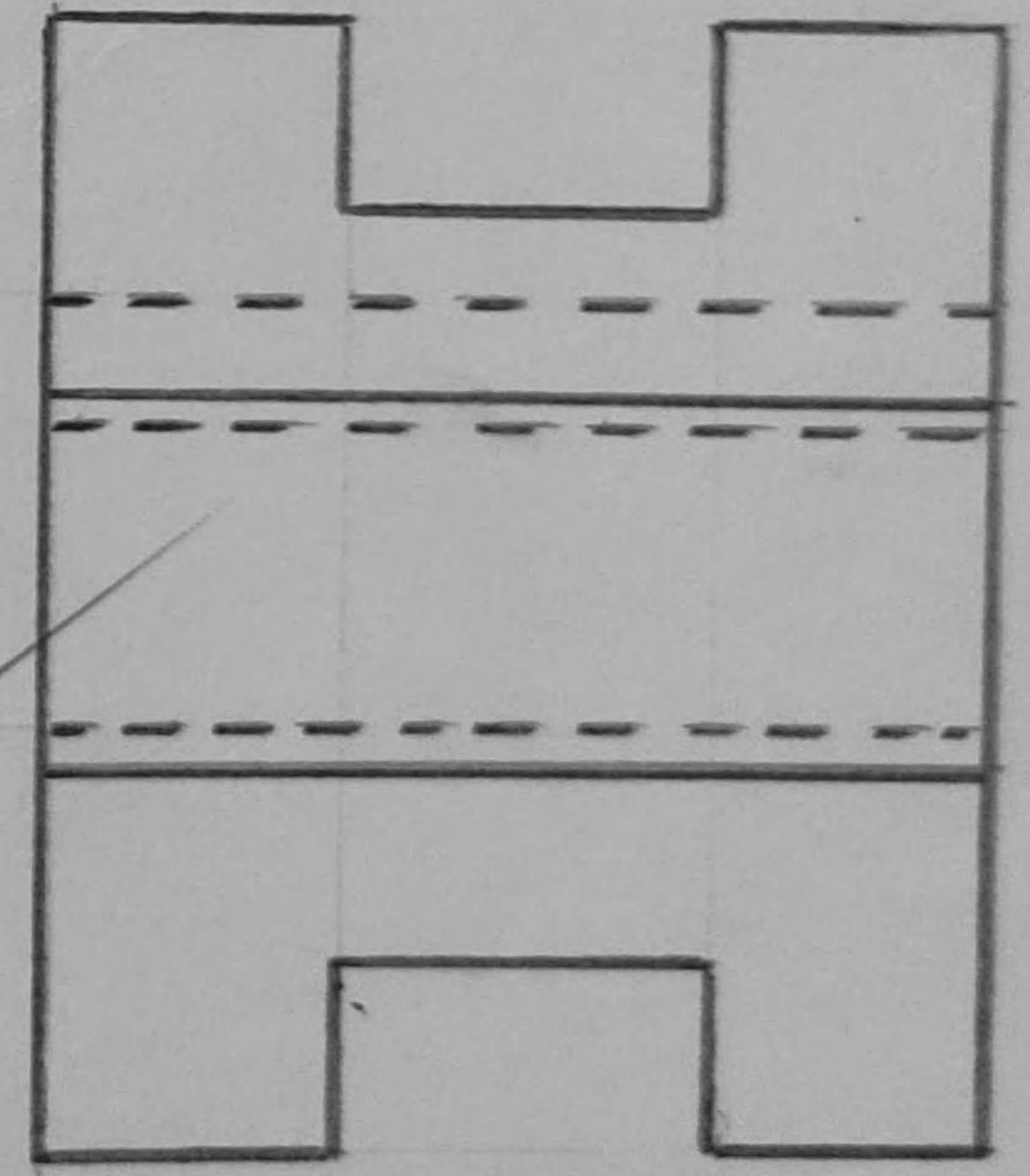
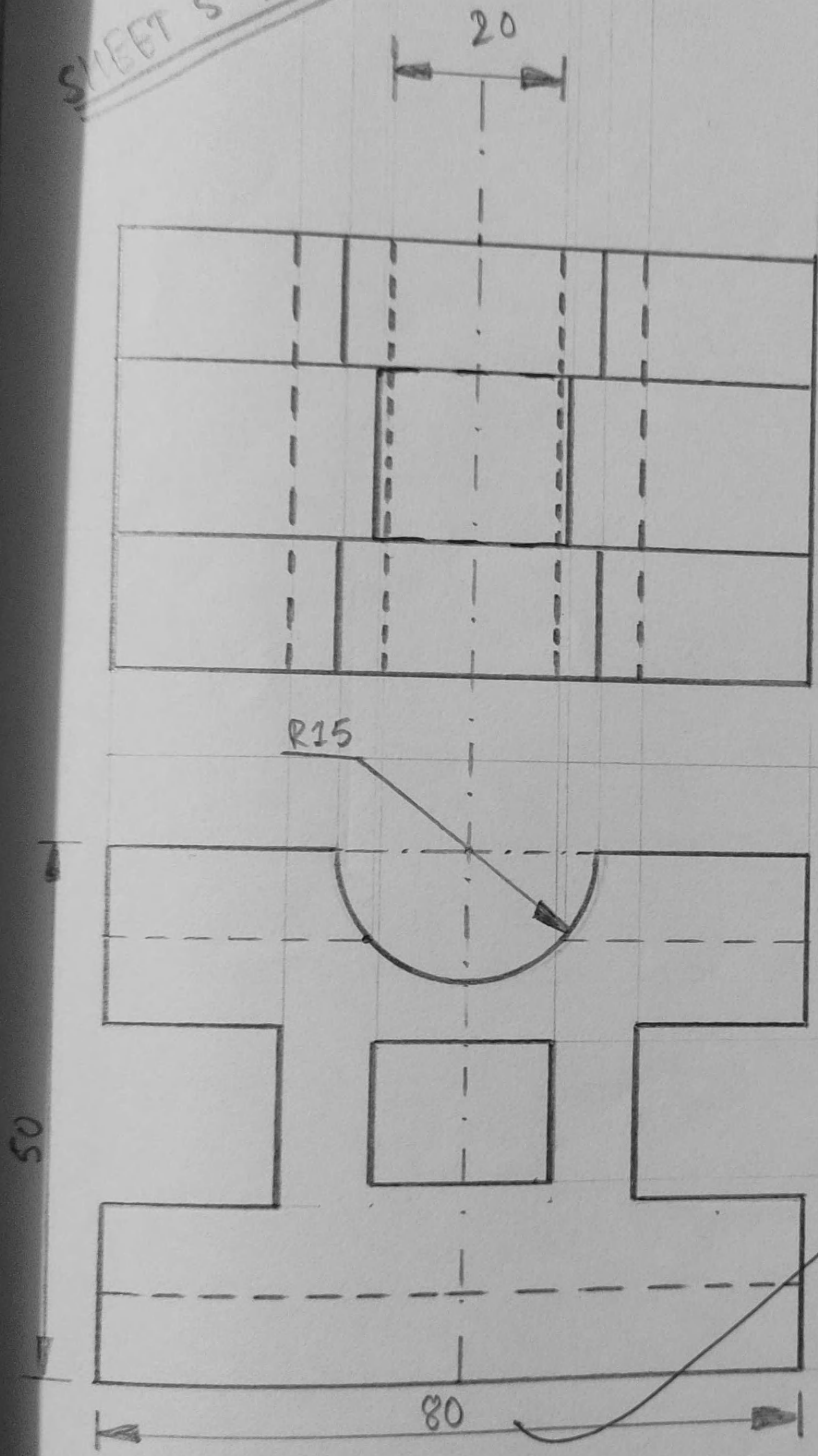
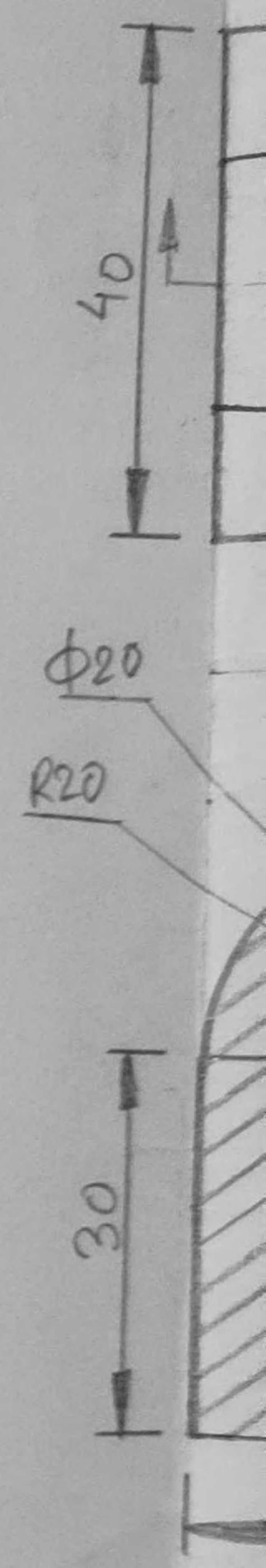

Fig 5.19



$\phi 20$
R20

Fig 5.20

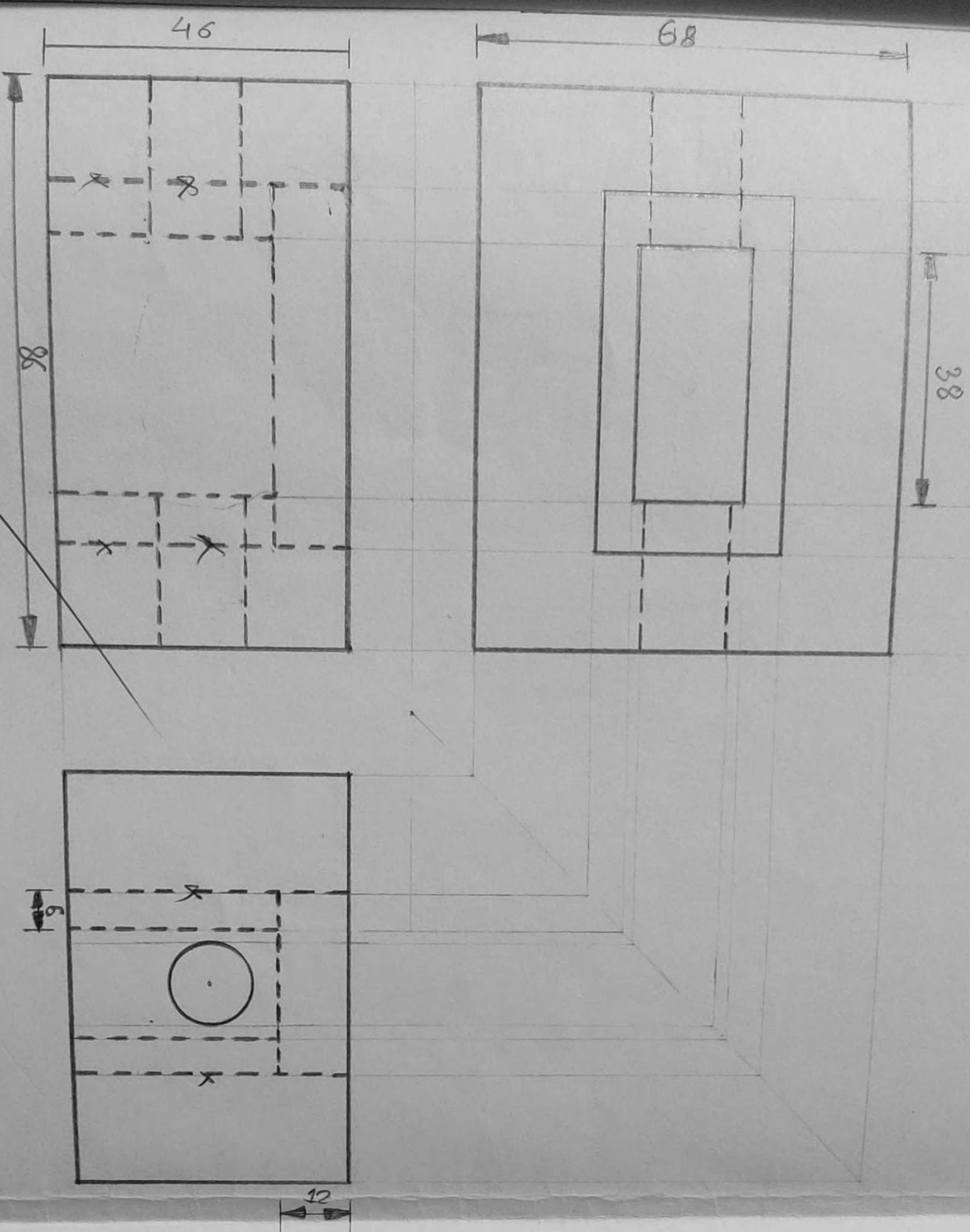

Fig 6.1

88

S.N.	DESCRIPTION	QTY	MATERIAL	REMARK
DRAWN BY	KRISHNA MURARI ARYAL			
ROLL NO.	009			NCE
CHKD BY				
TITLE				
SCALE	1:1			DRG. SHEET NO. 9
DATE	20/5/08/22			
METRIC SYSTEM				

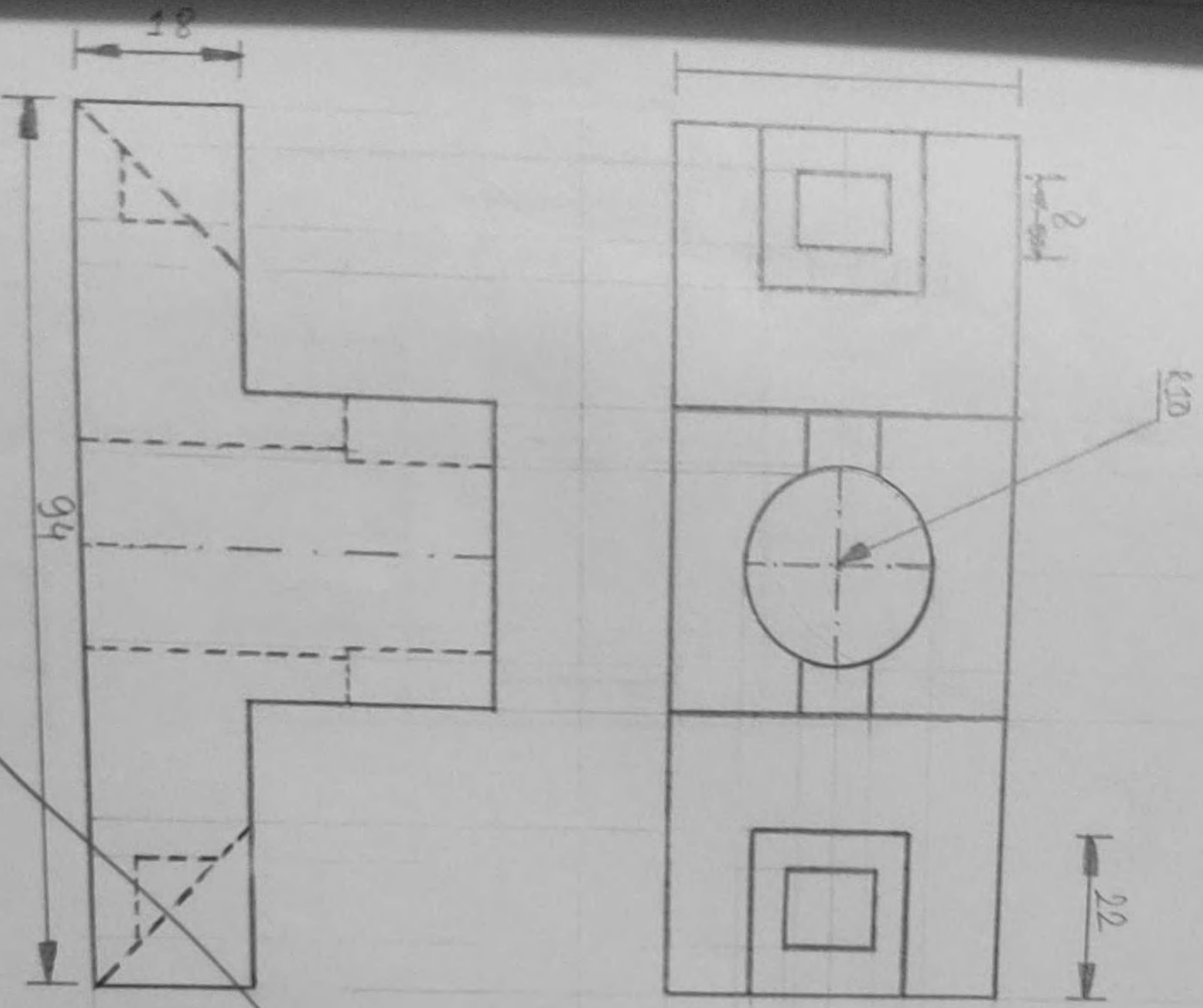

Fig 6.5

OK

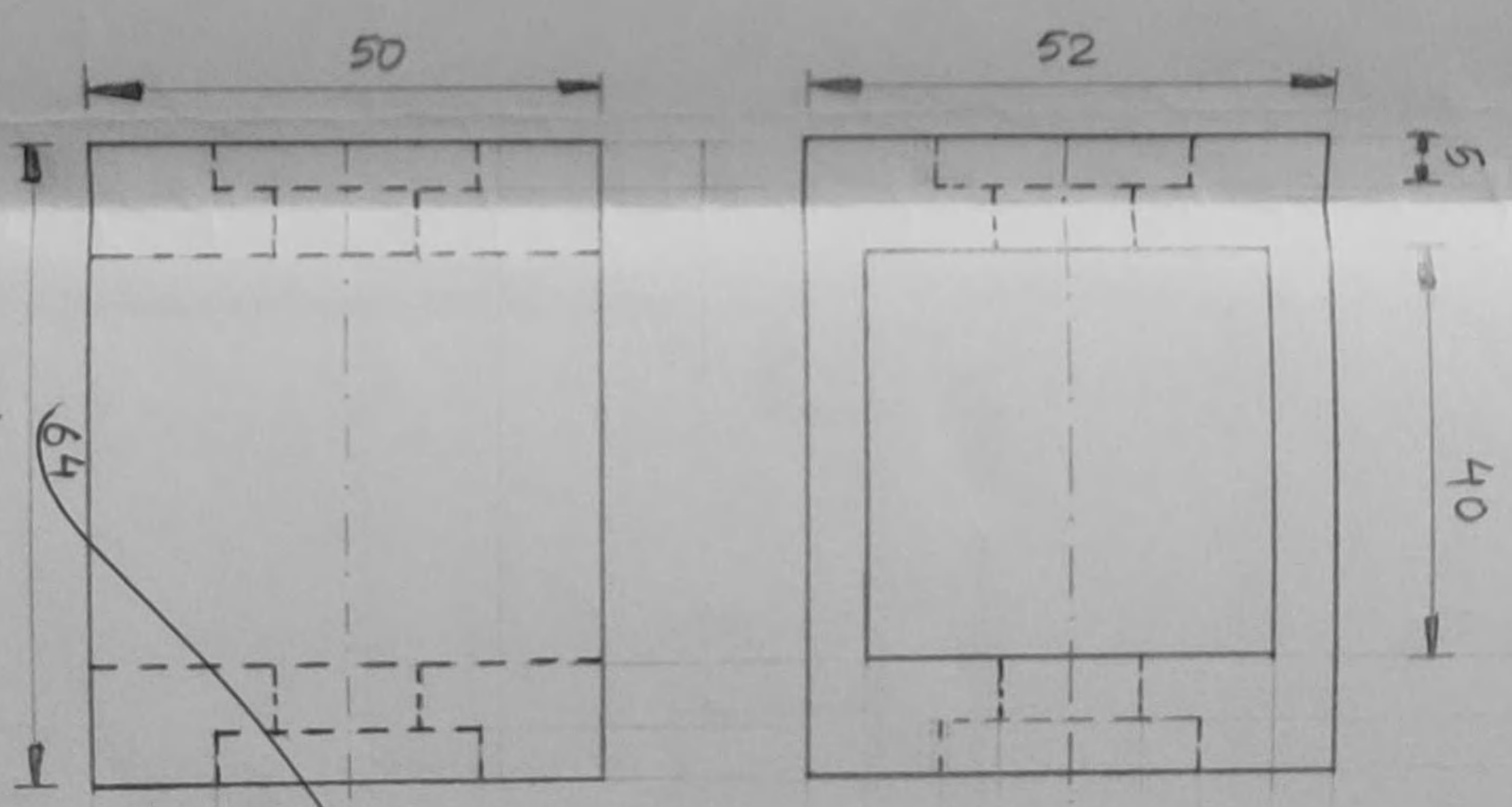
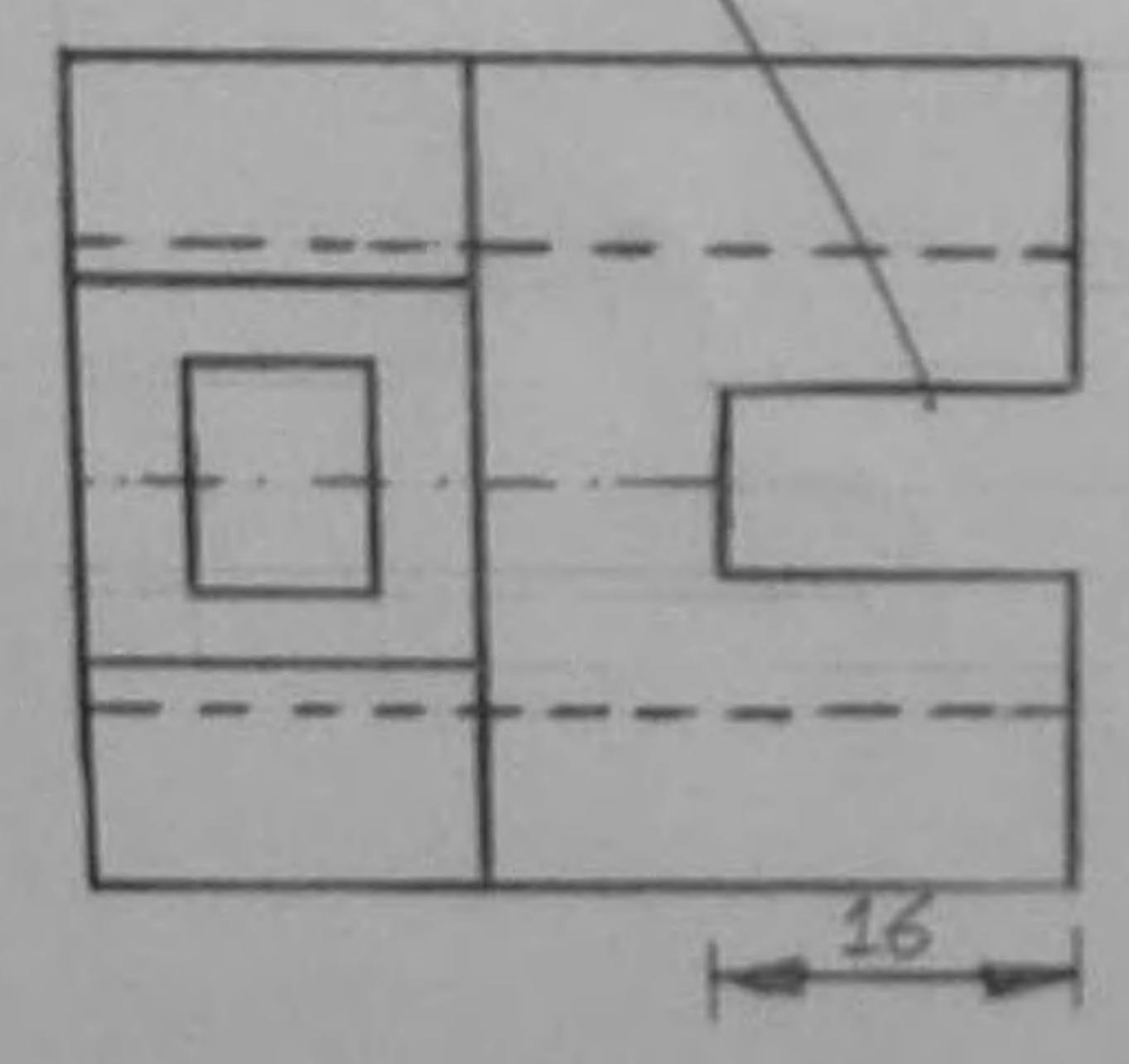
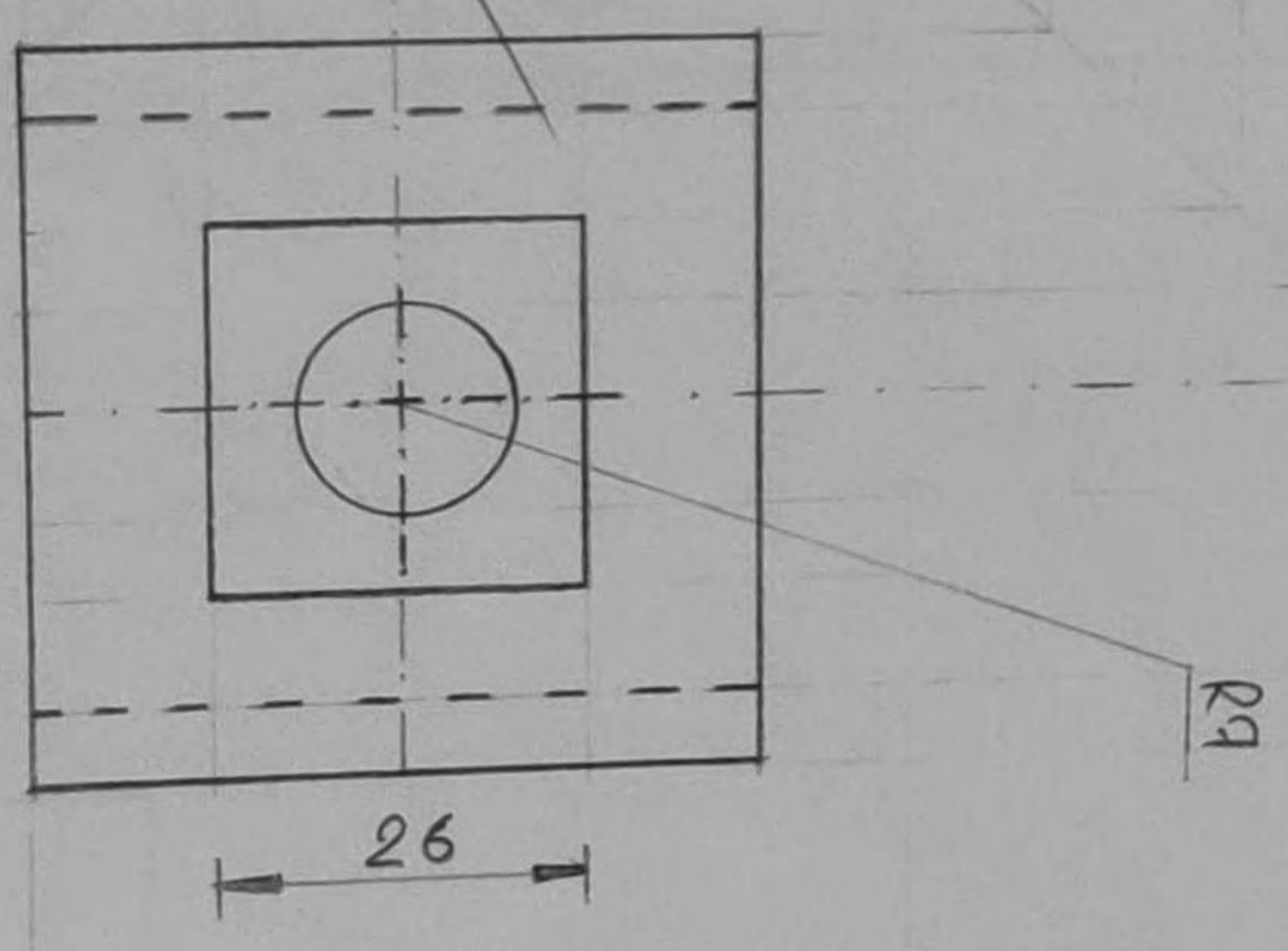
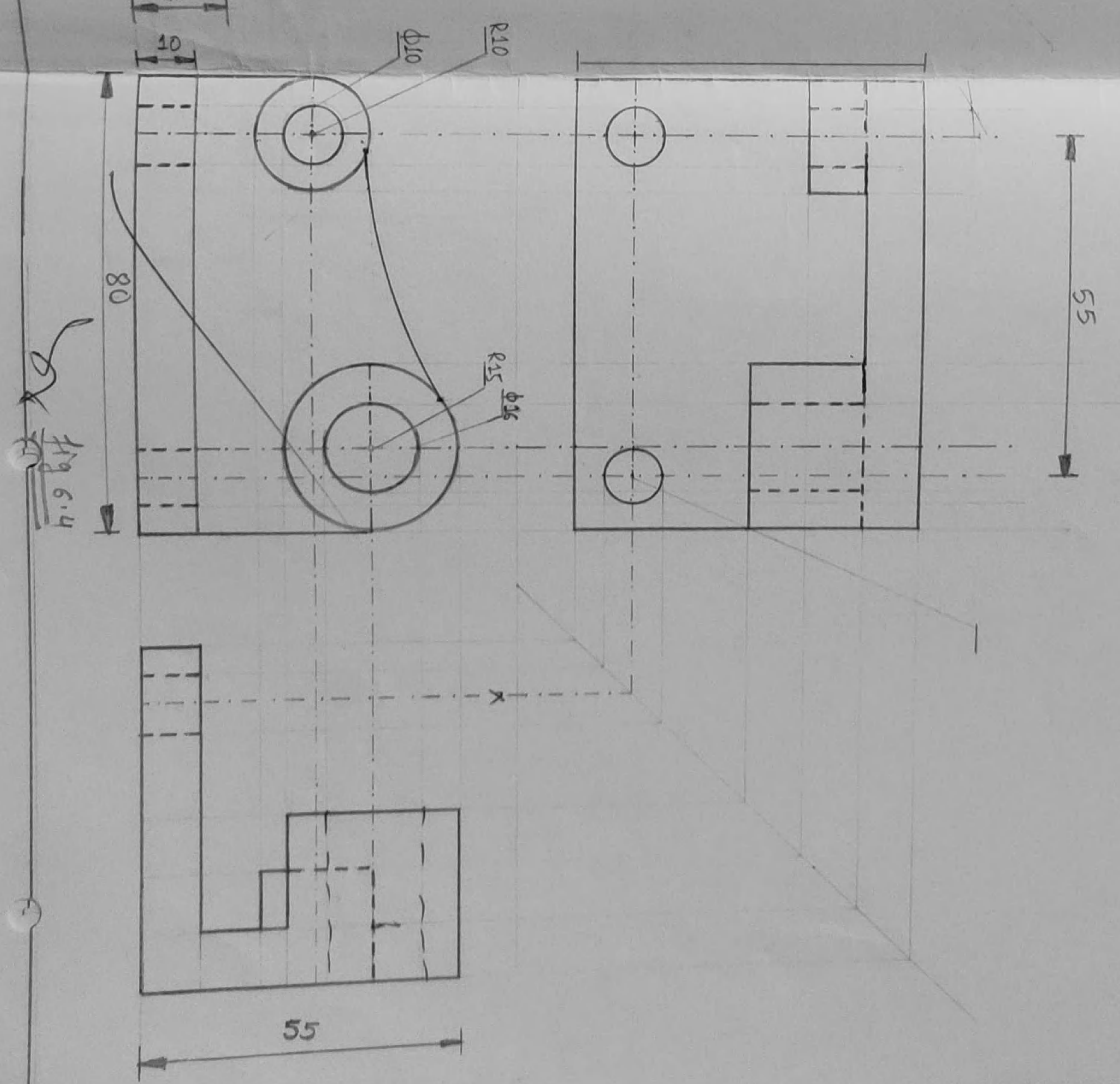
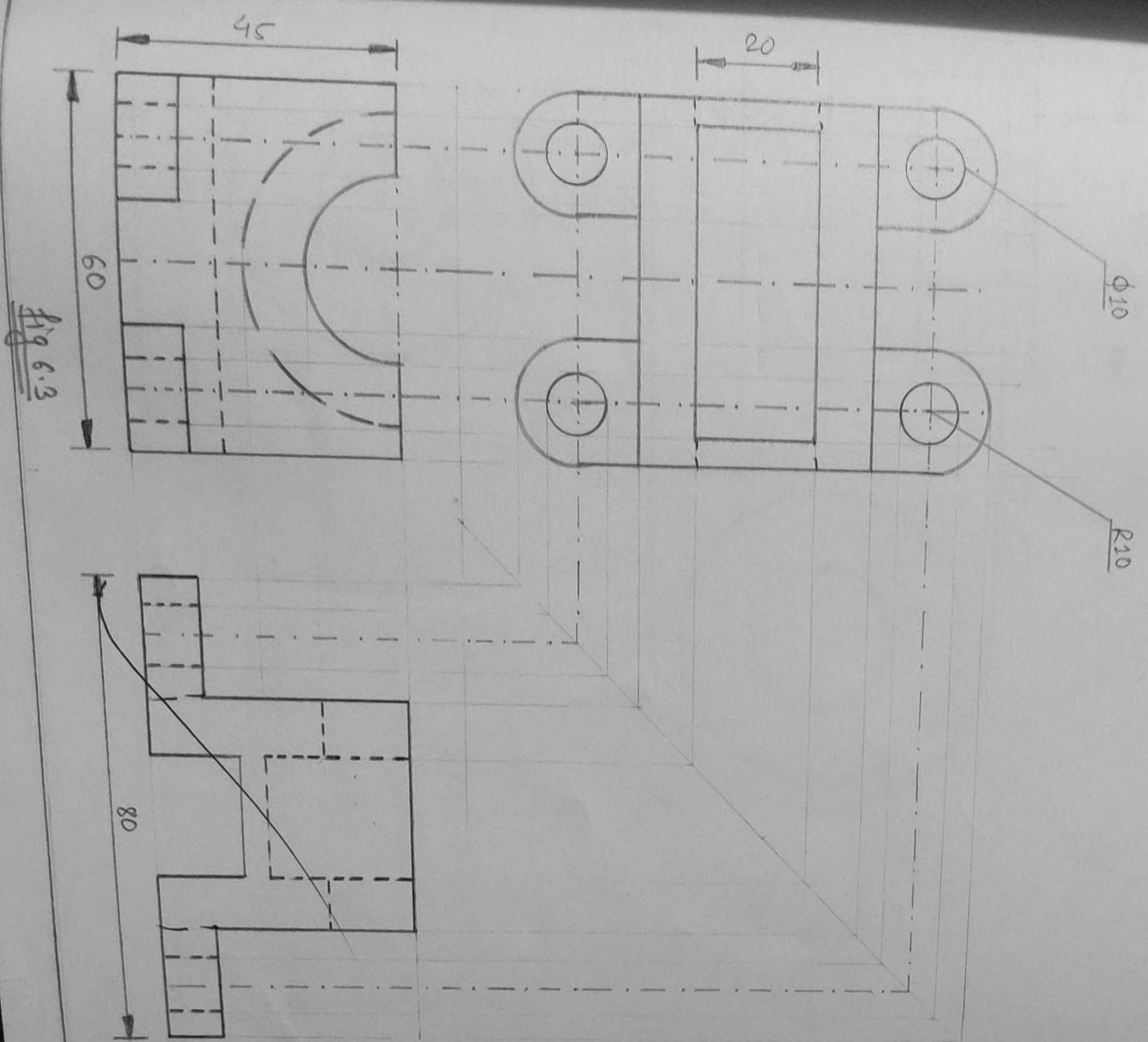

Fig 6.2

OK



S.N.	DESCRIPTION	QTY.	MATERIAL	REMARK
DRAWN BY	KRISHNA MURARI ARYAL			
ROLL NO	009			NCF
CHKD BY				
TITLE				
SCALE	1:1		DRG SHEET NO.	10
DATE	2015108130			
METRIC SYSTEM				



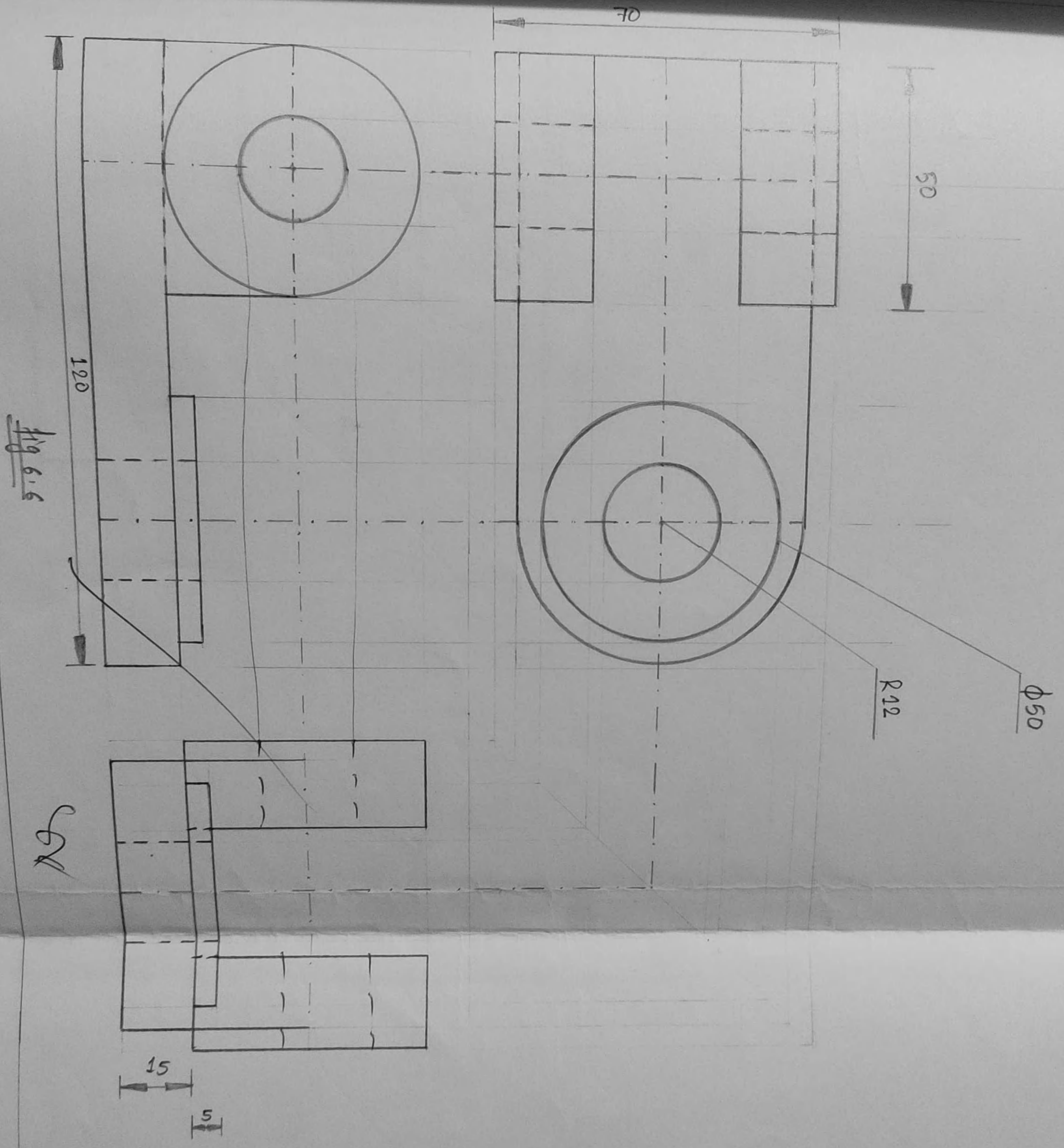

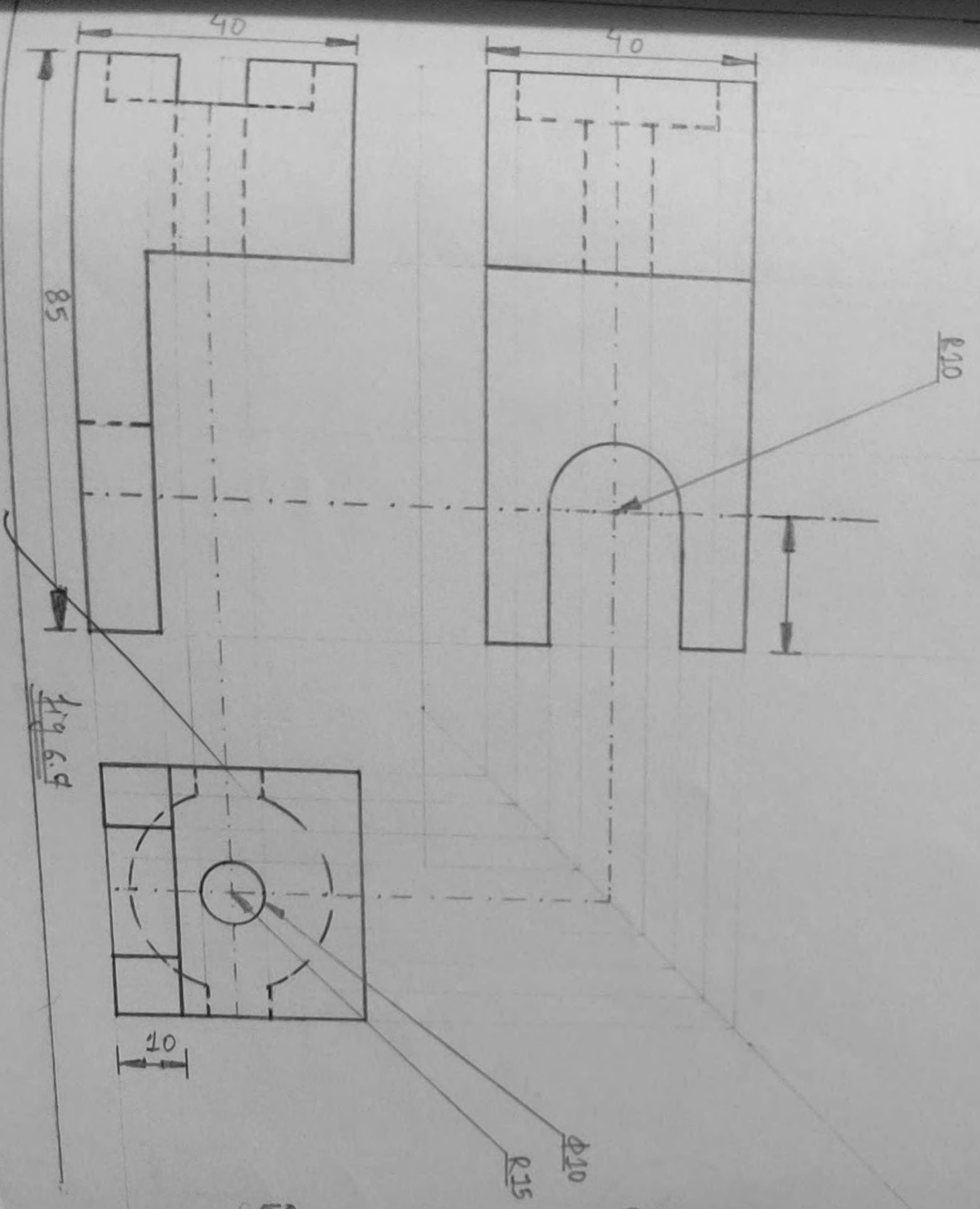

Fig 6.9

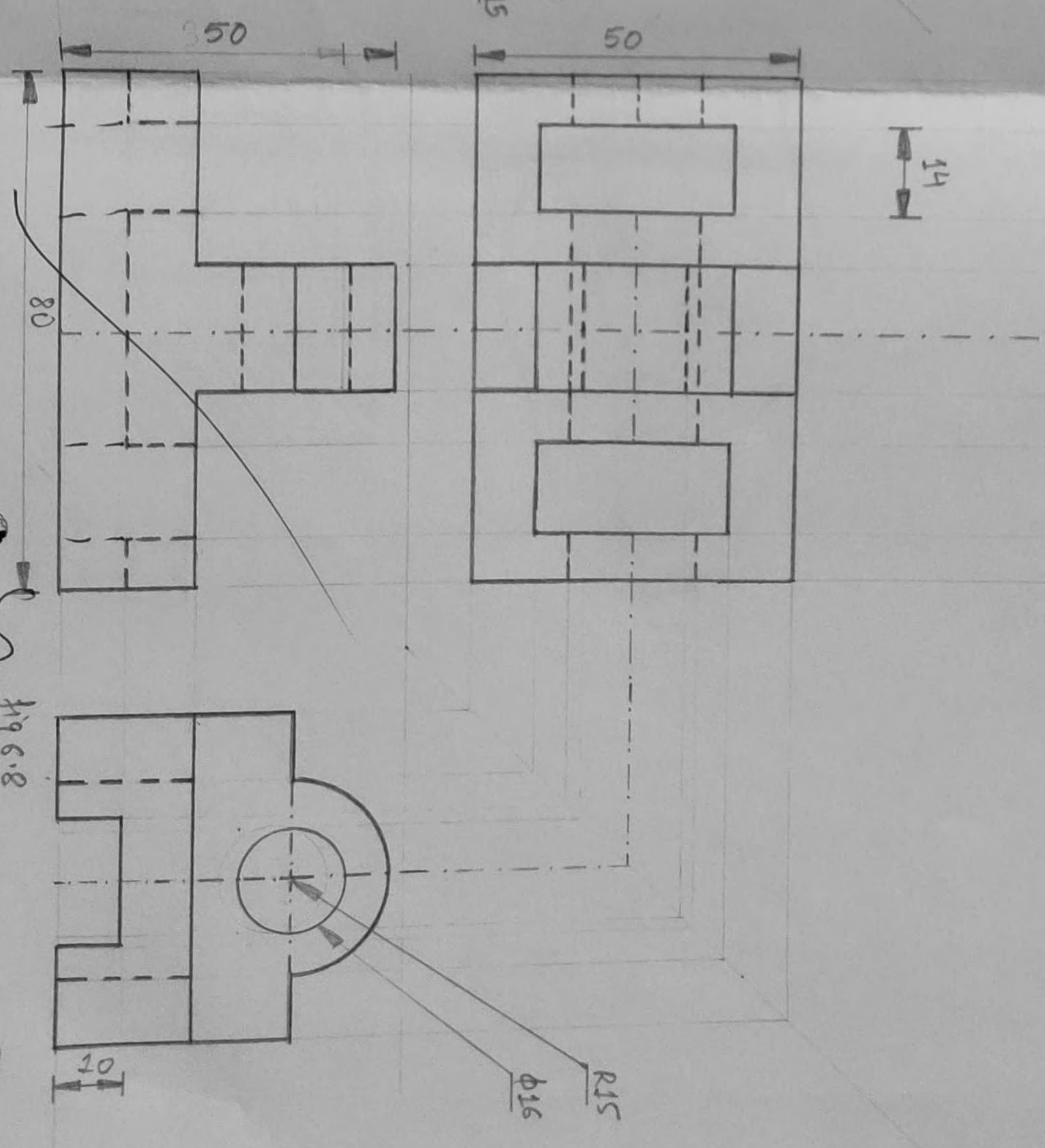
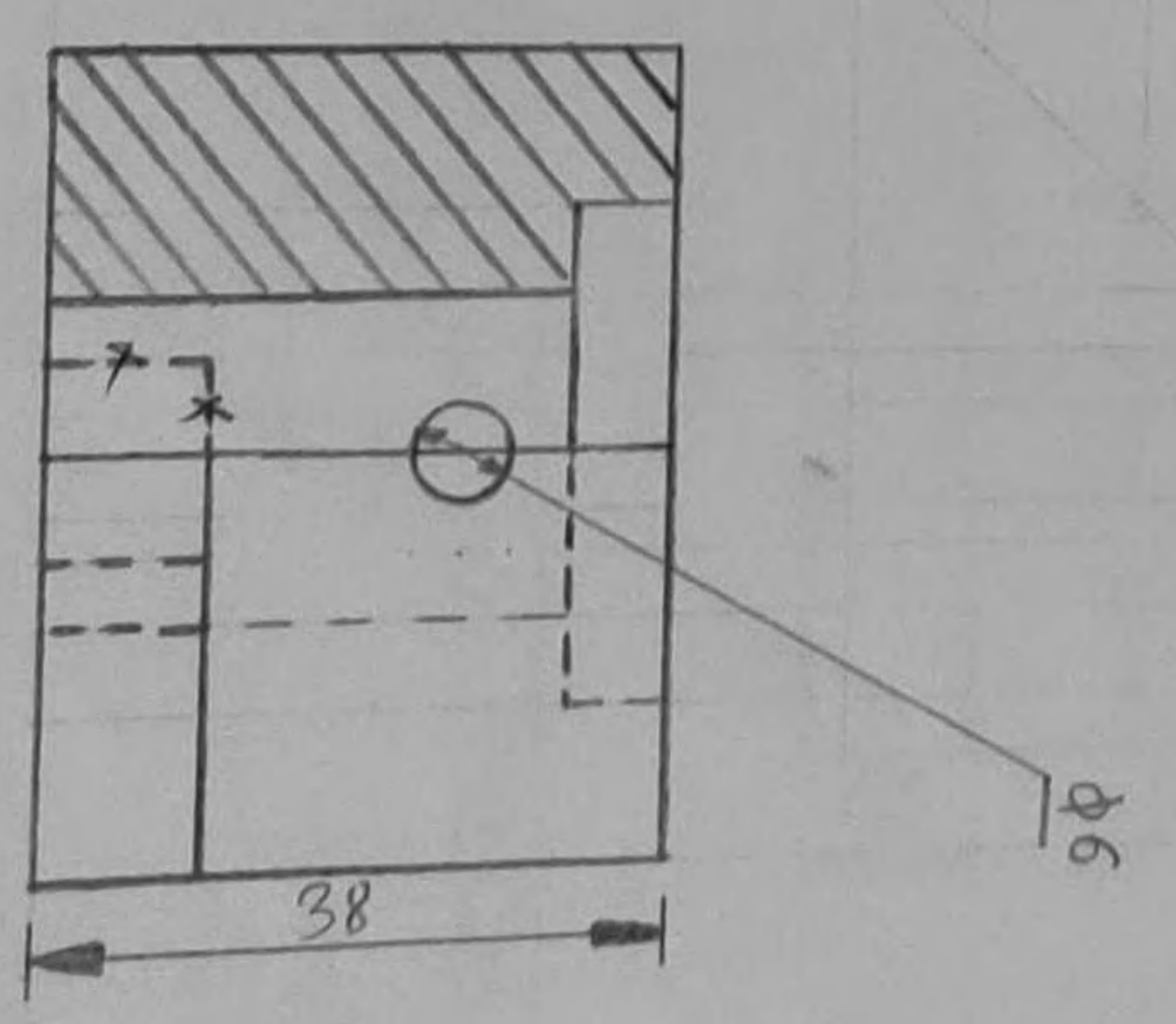
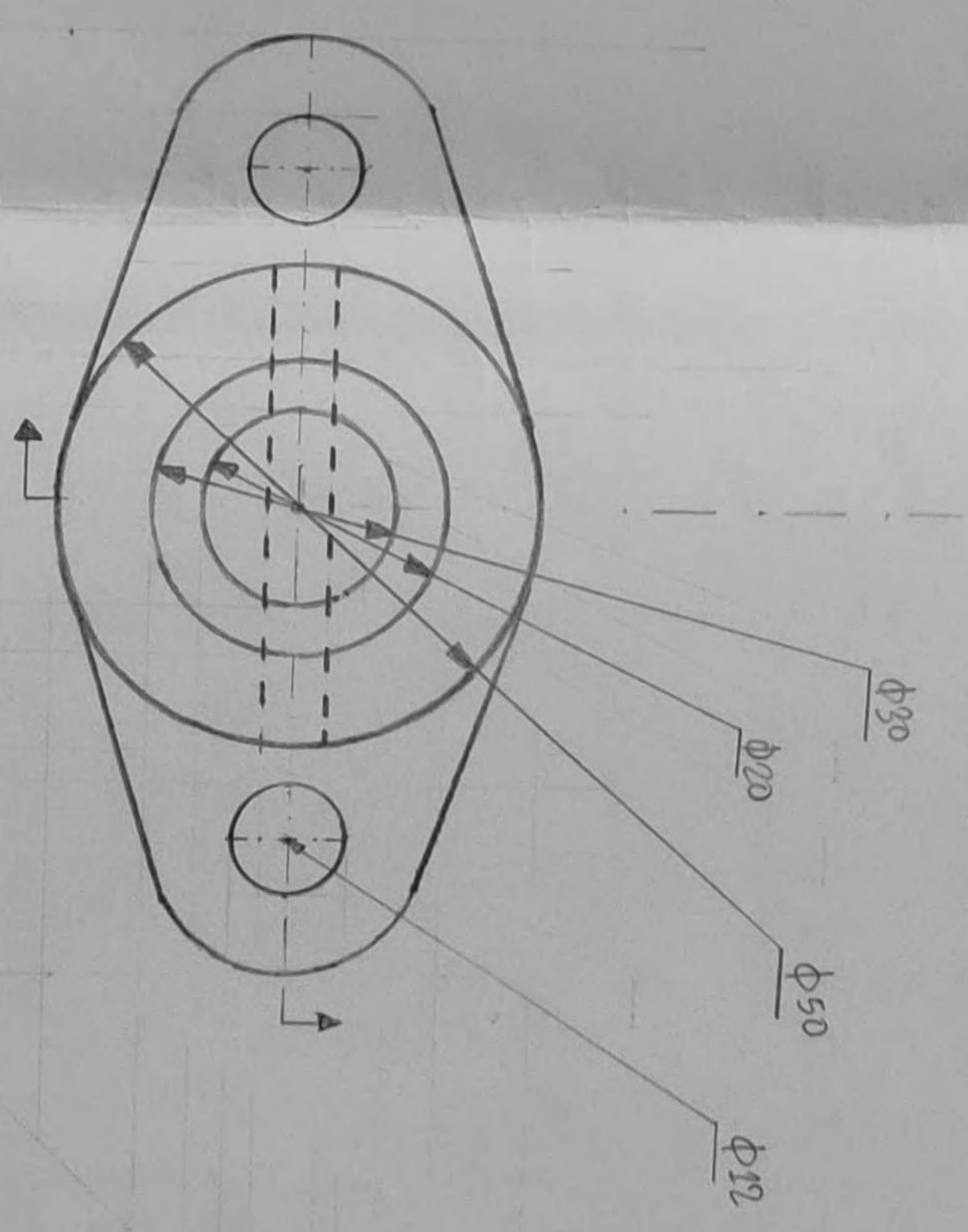
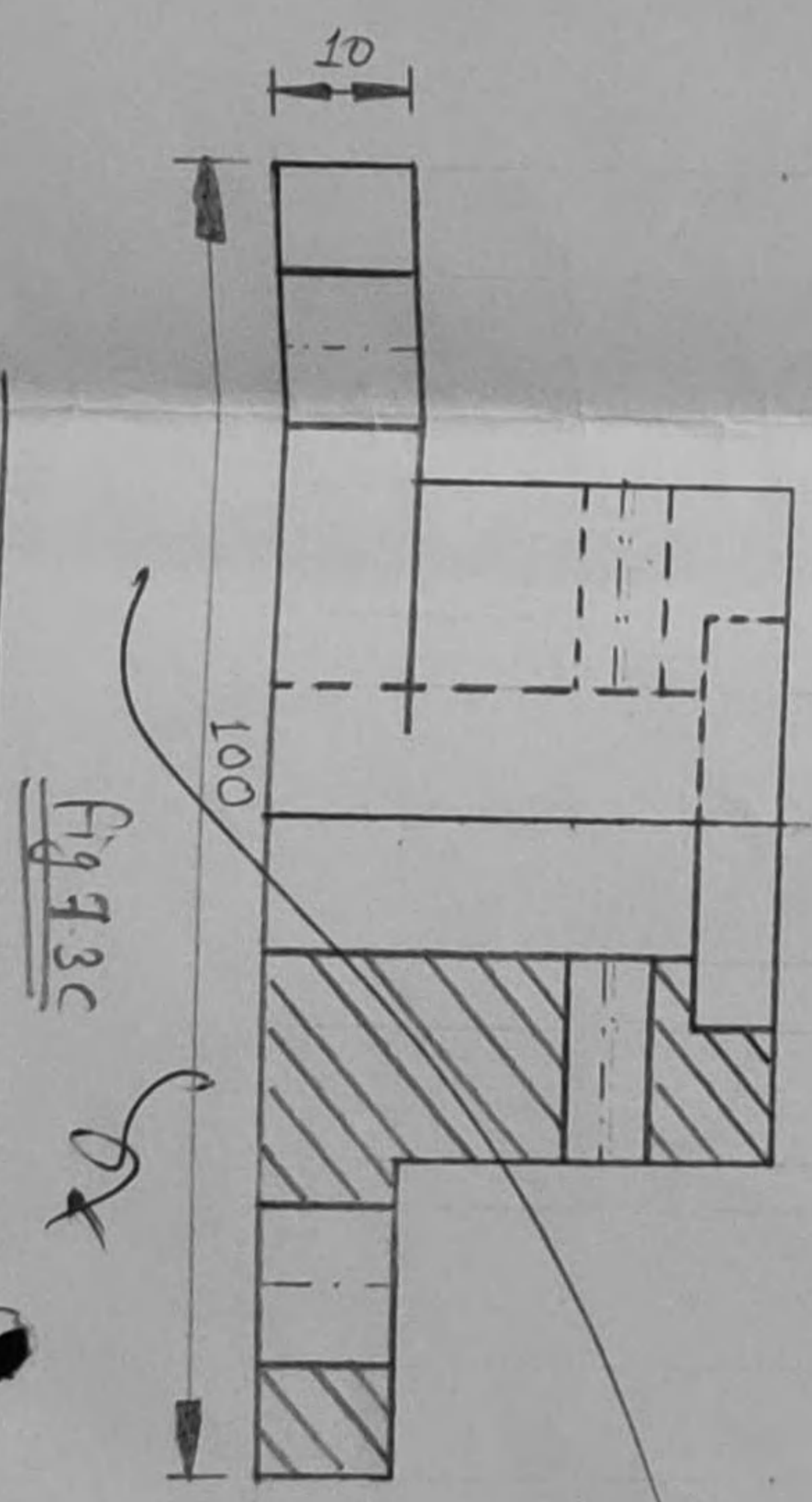
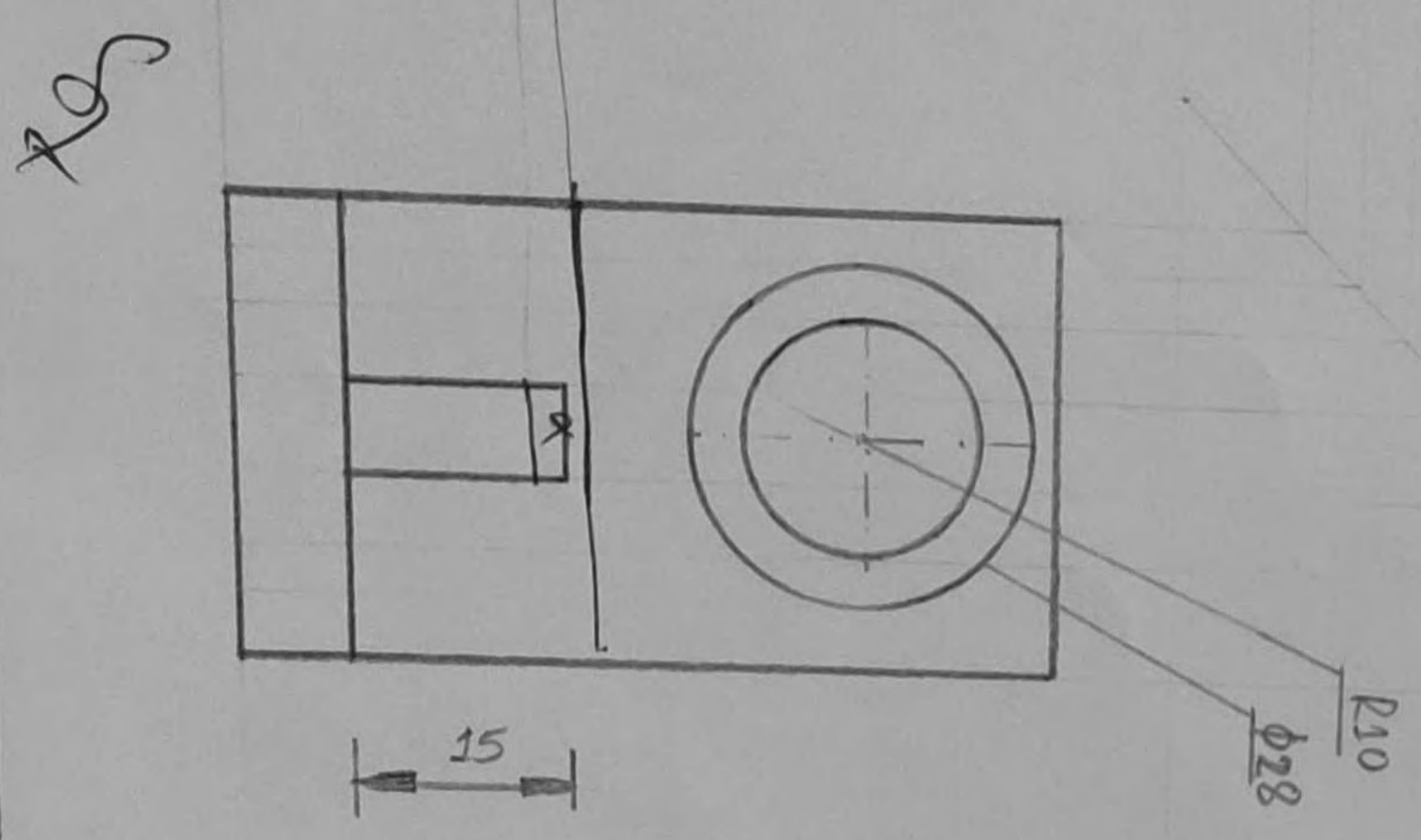
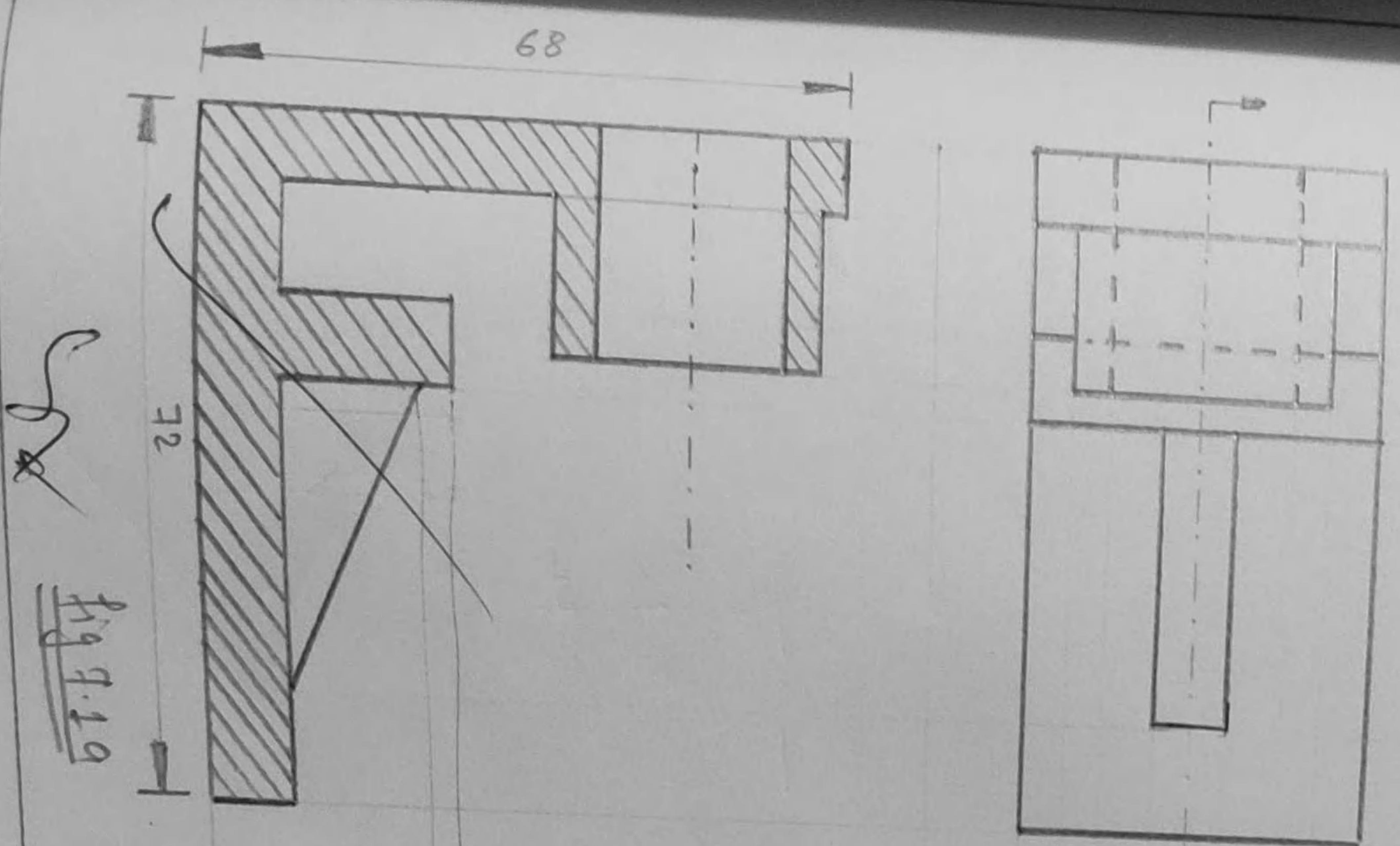
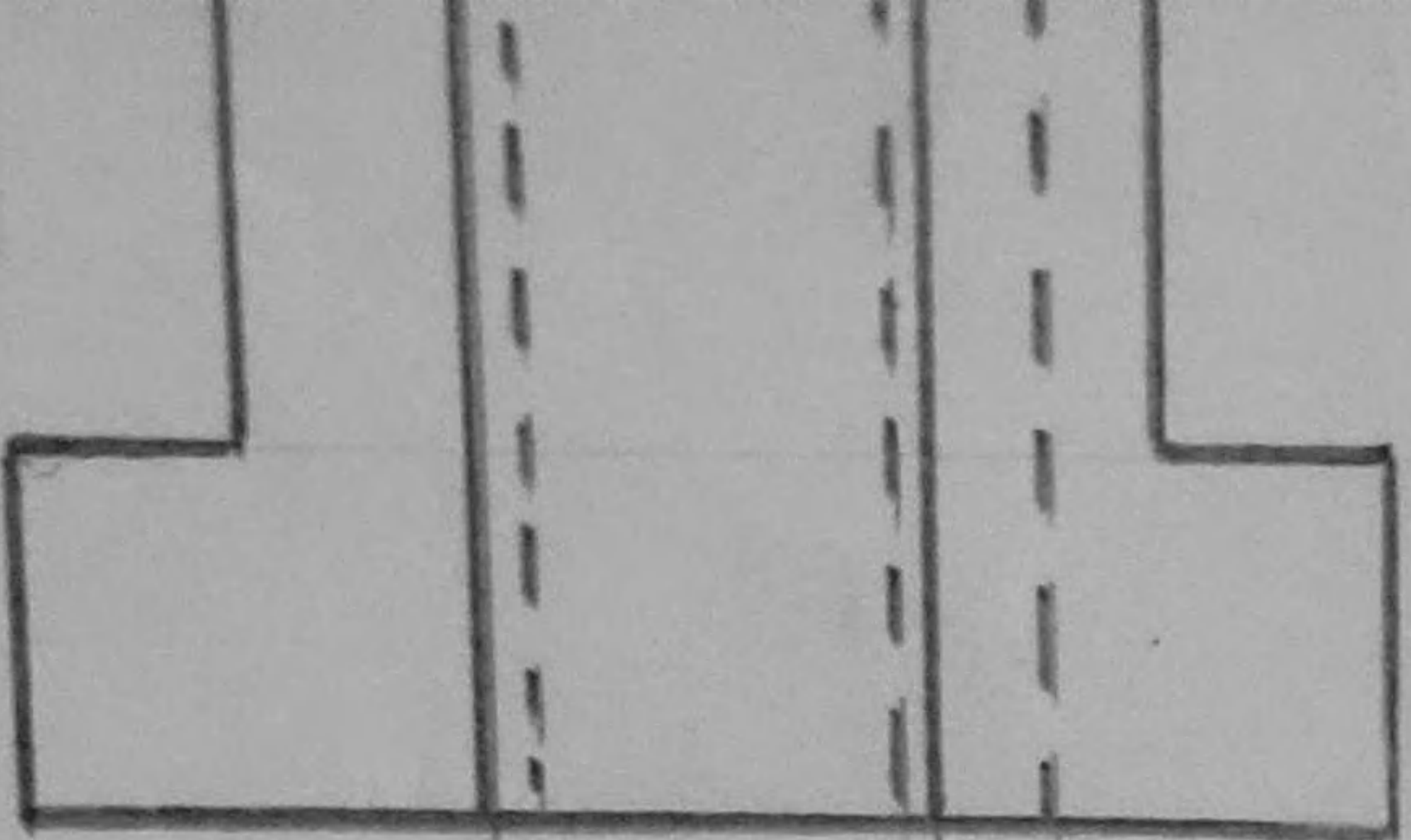
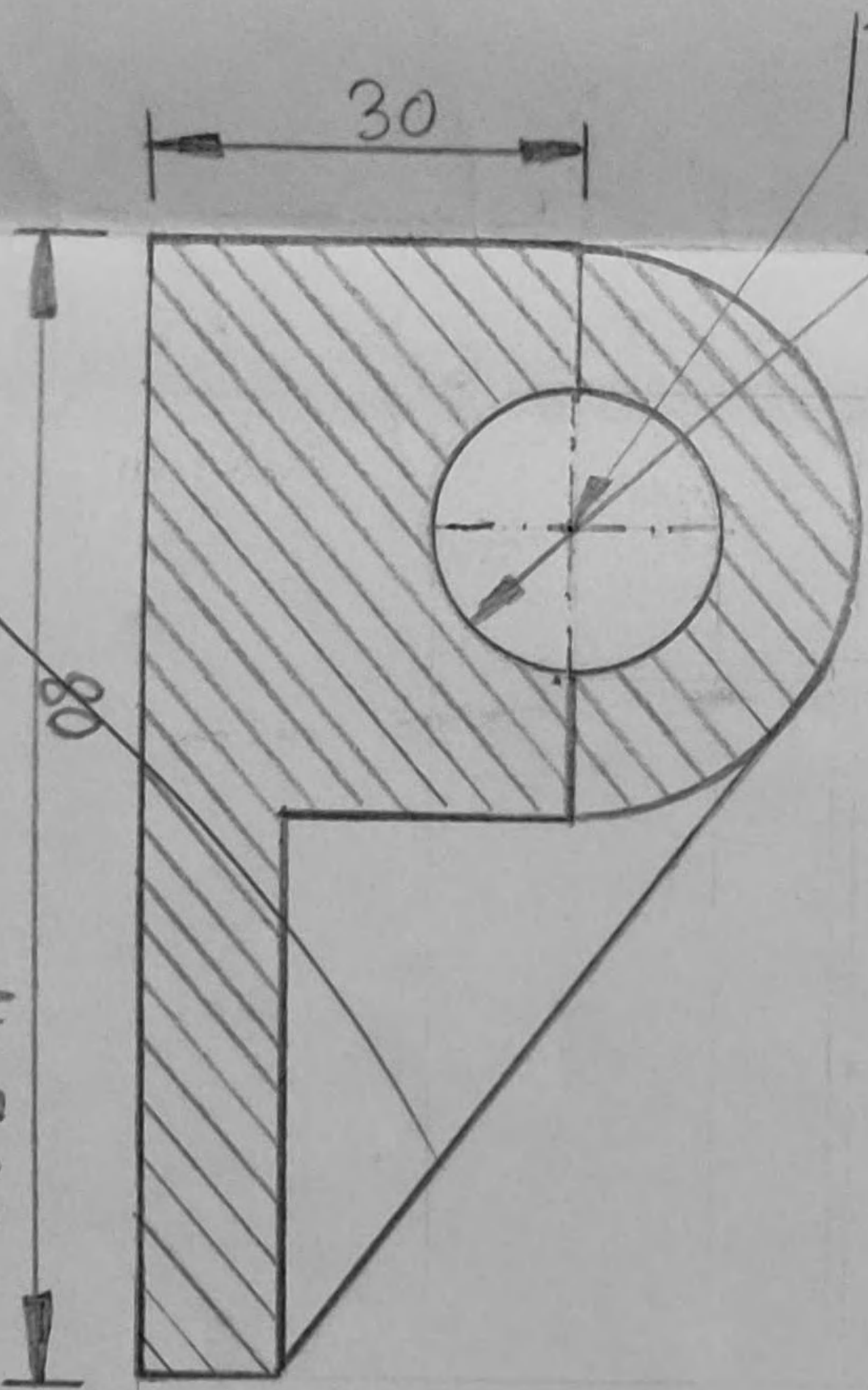

Fig 6.8





10 20



80 30 20 20

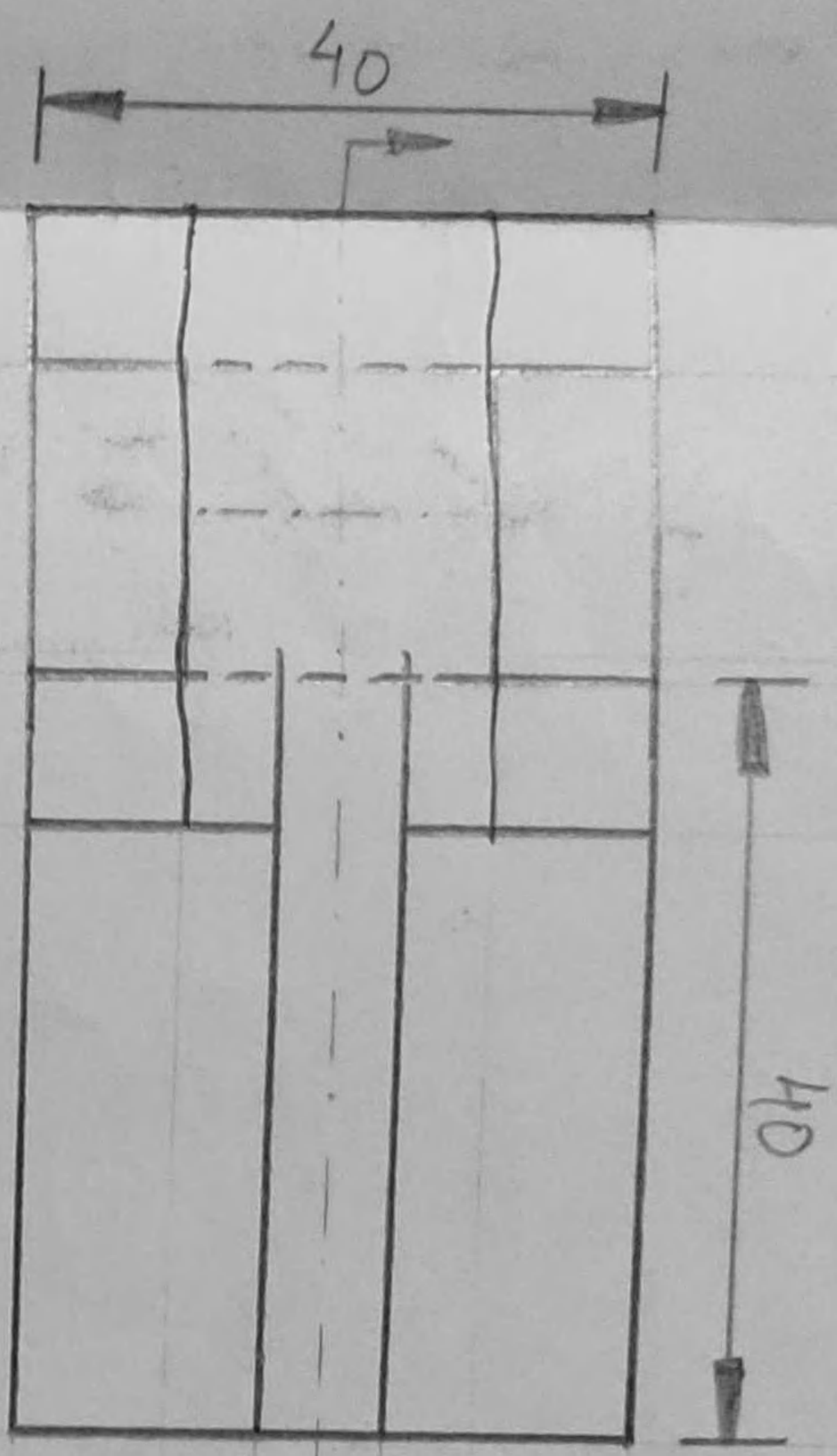

40

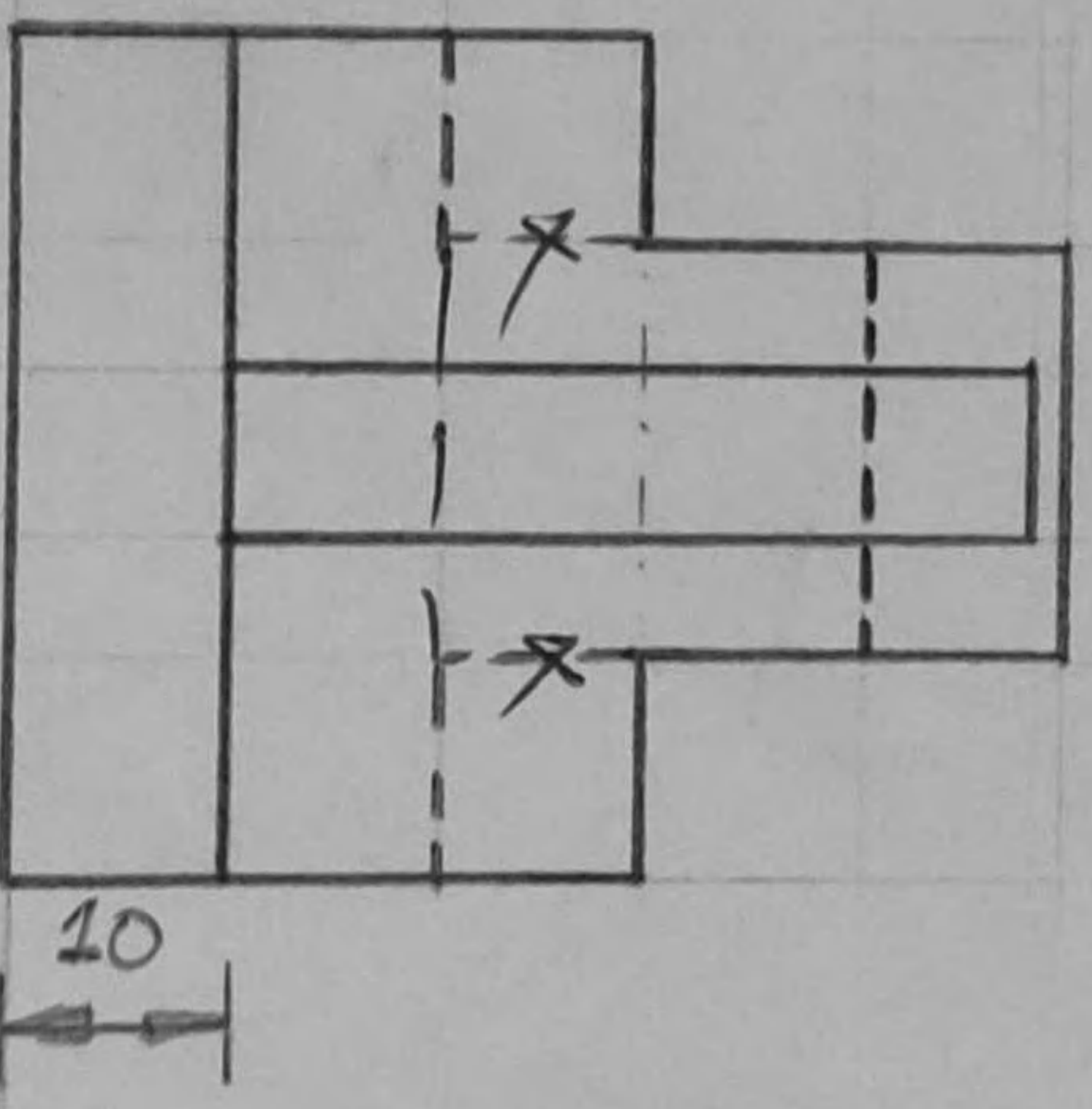

10

S.N.	DESCRIPTION	QTY	MATERIAL	REMARK
199.1.6				
DRAWN BY	KRISHNA MURARI ARYAL			
ROLL NO				
CHKD BY				NCE
TITLE				
SCALE	1:1			DRG SHEET NO. 11
DATE	2075109124			
METRIC SYSTEM				

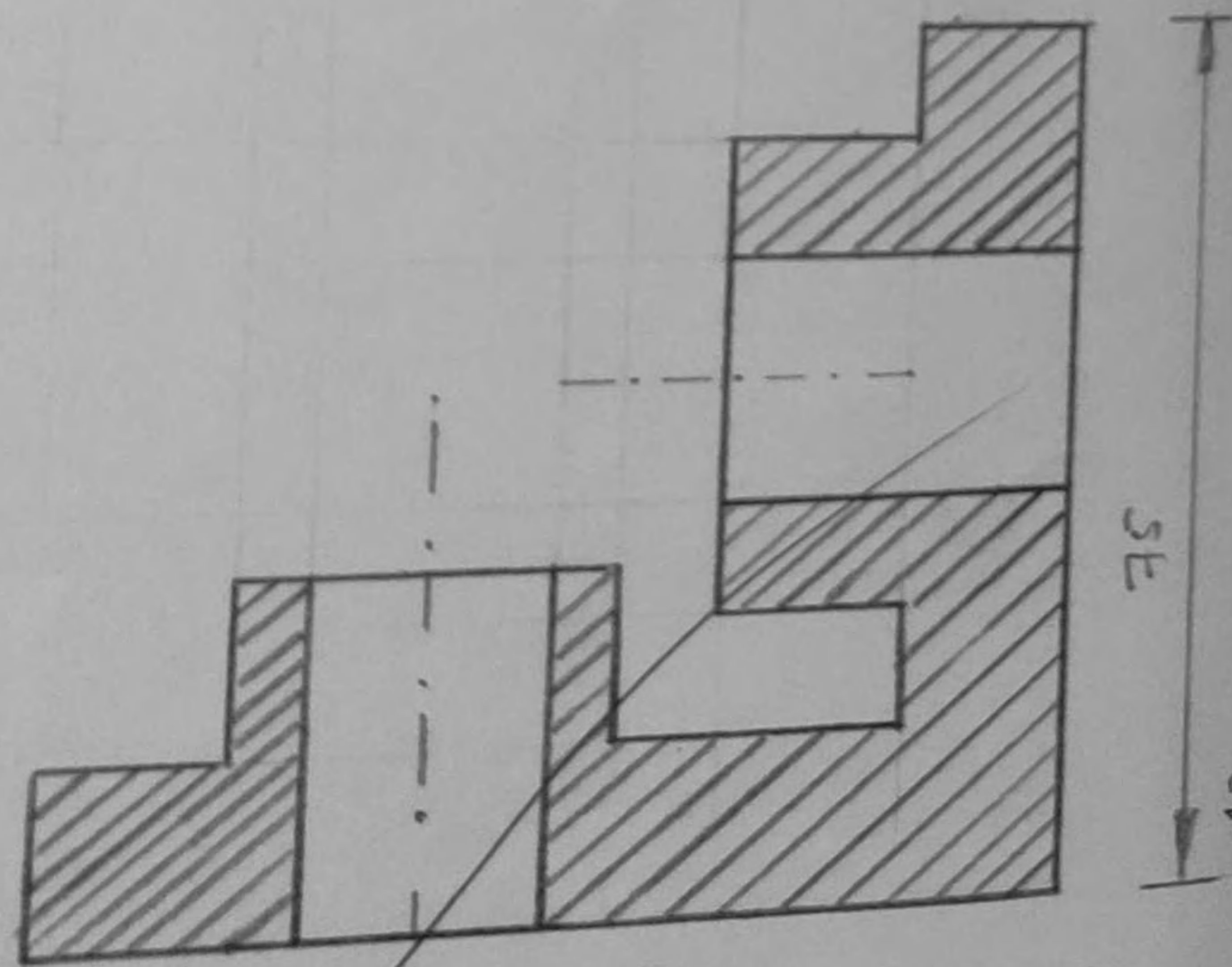
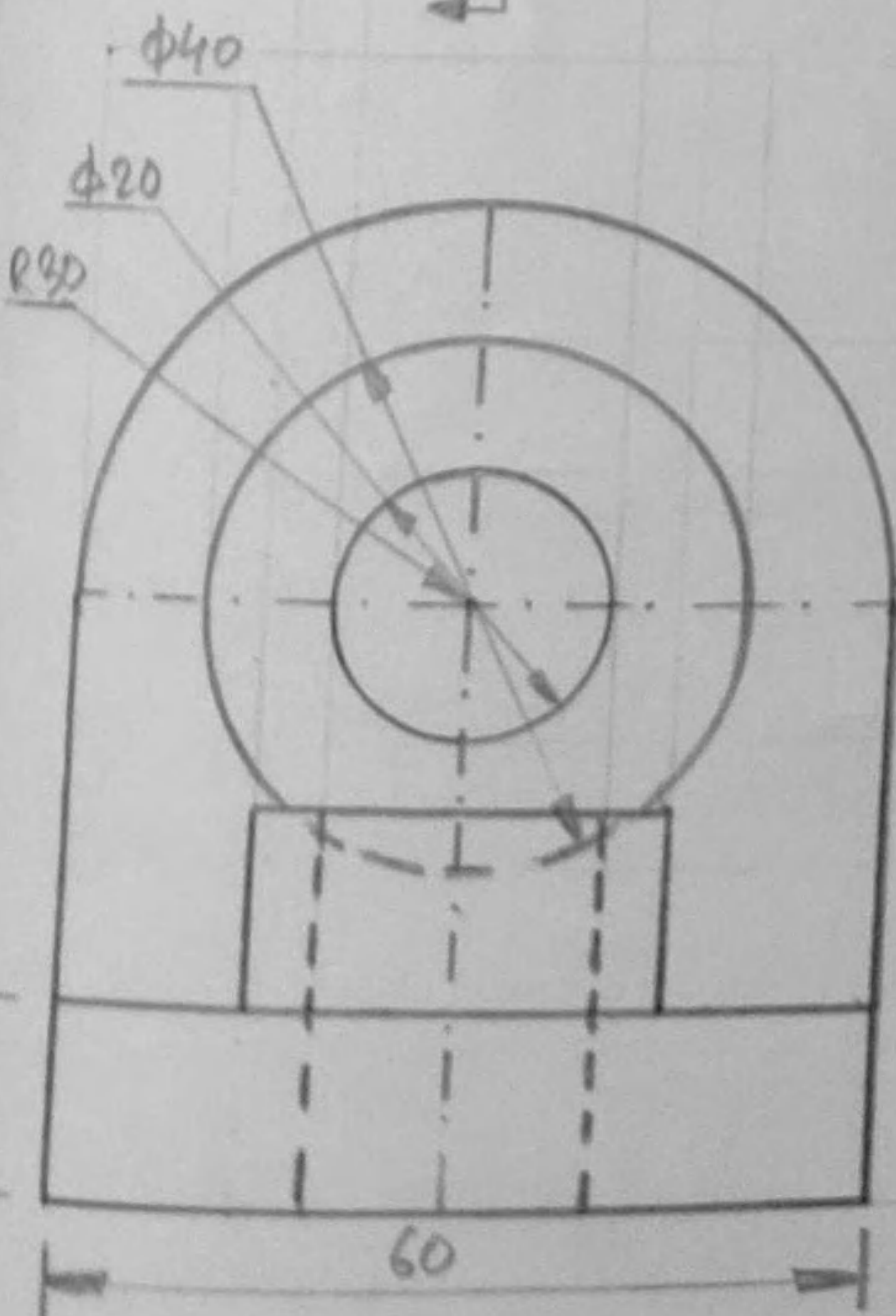
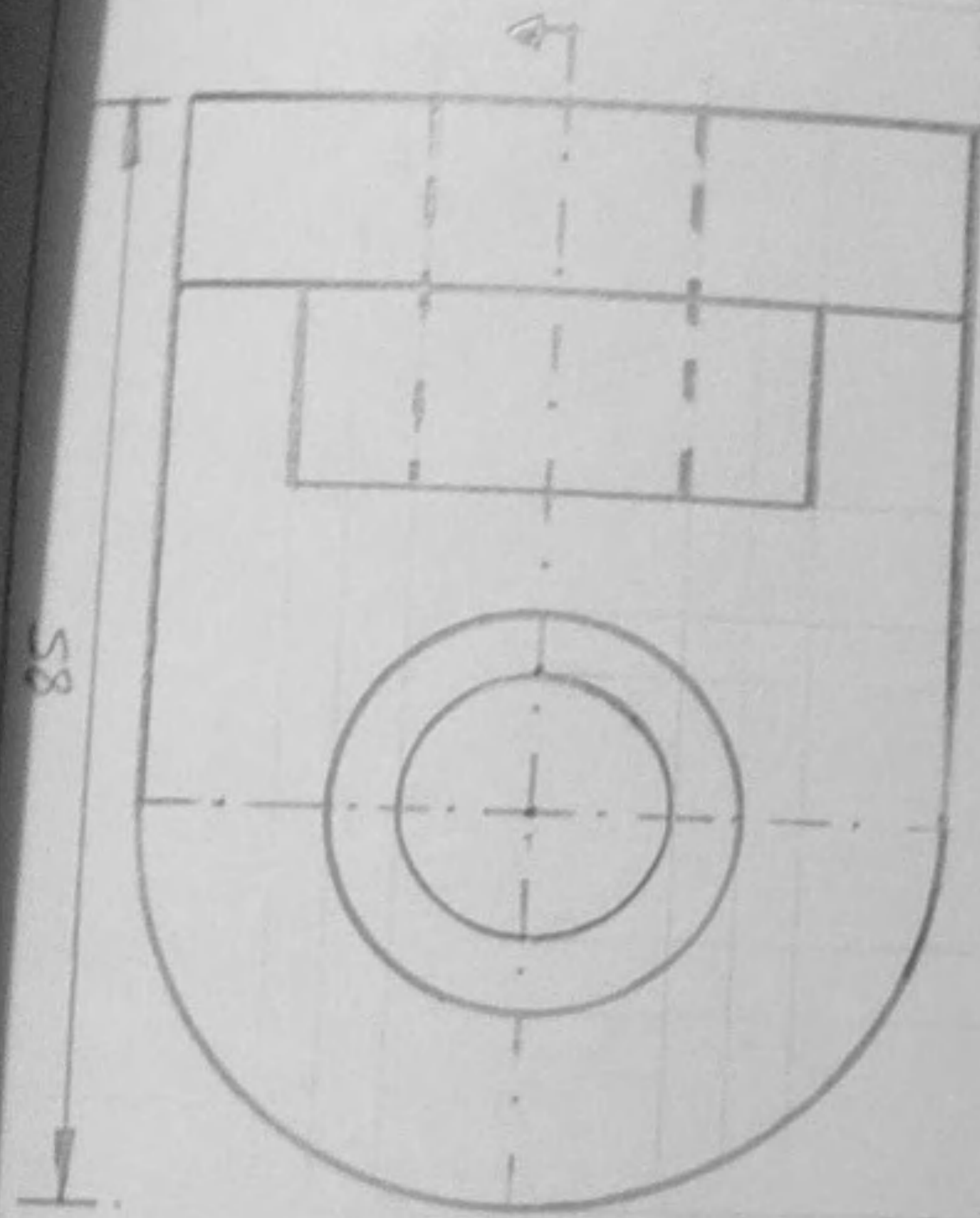

fig 7.2(a)

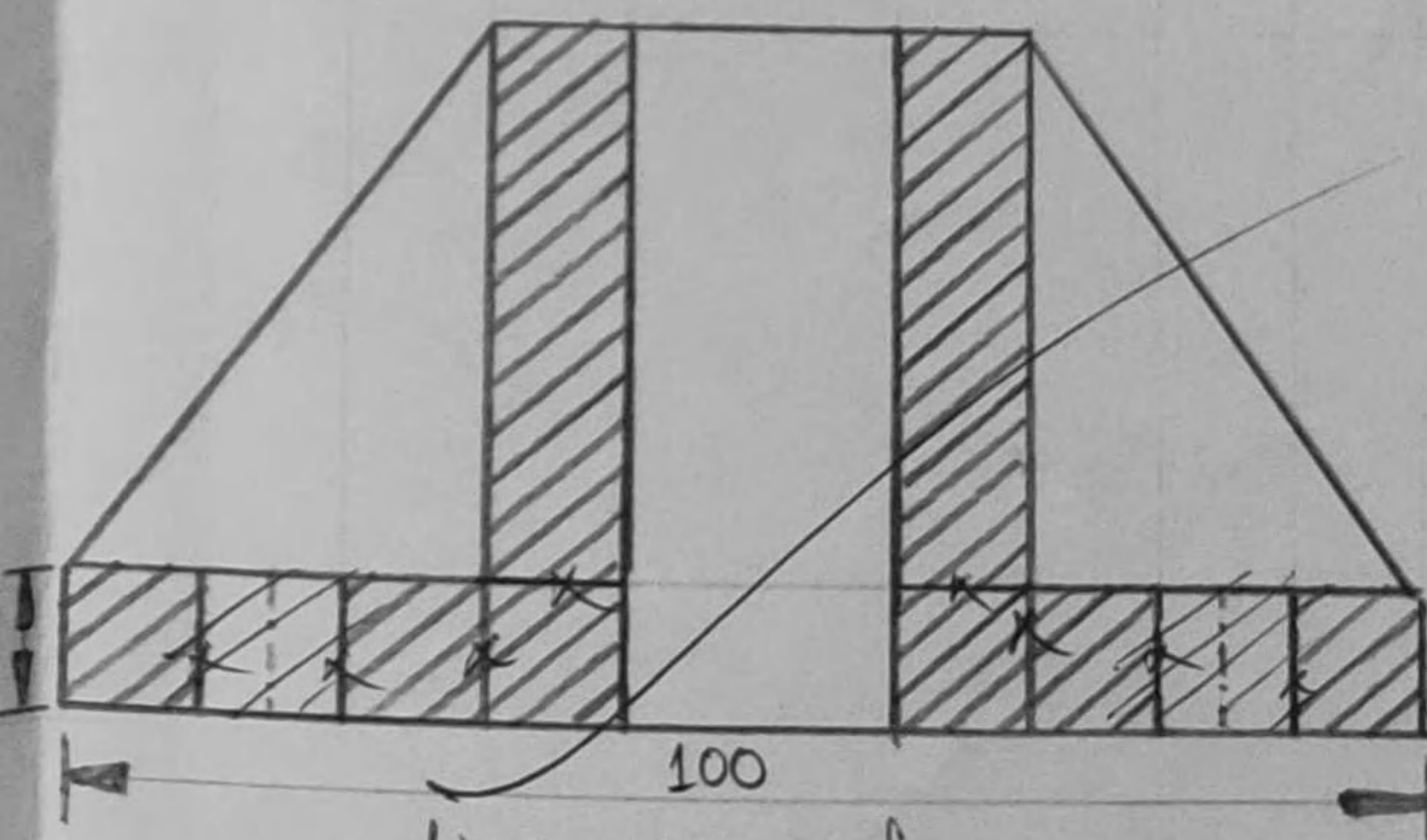
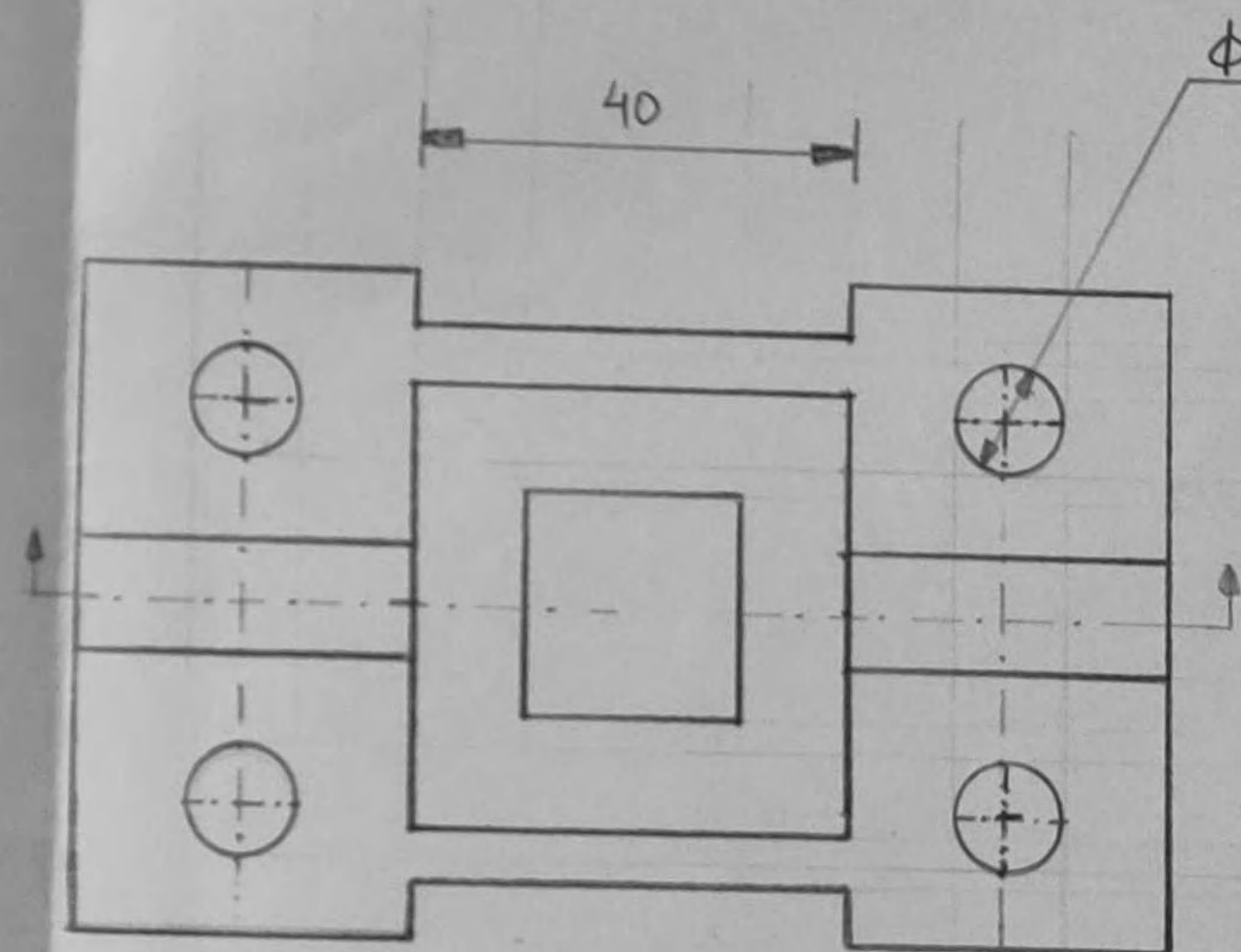
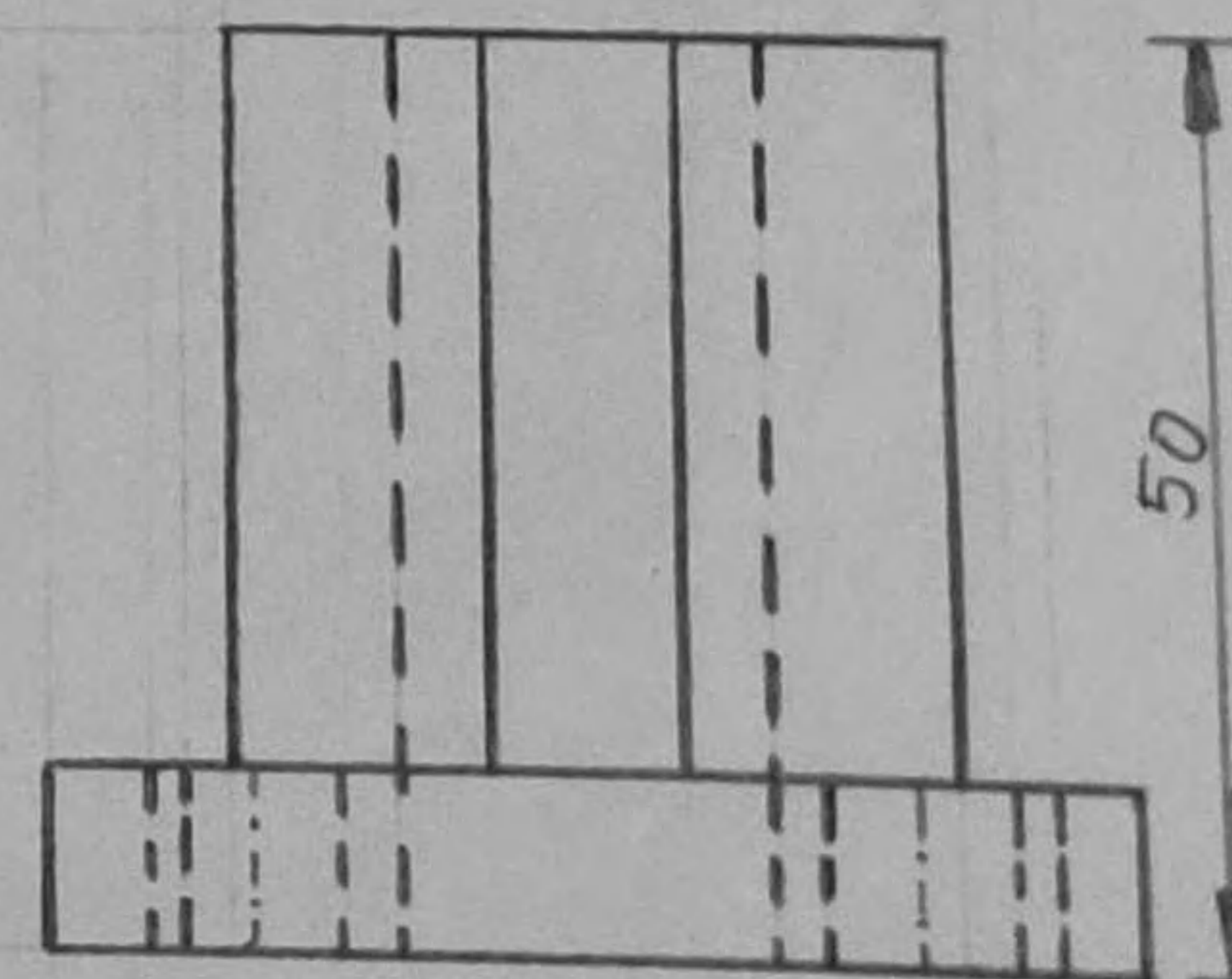

fig 7.2(b)



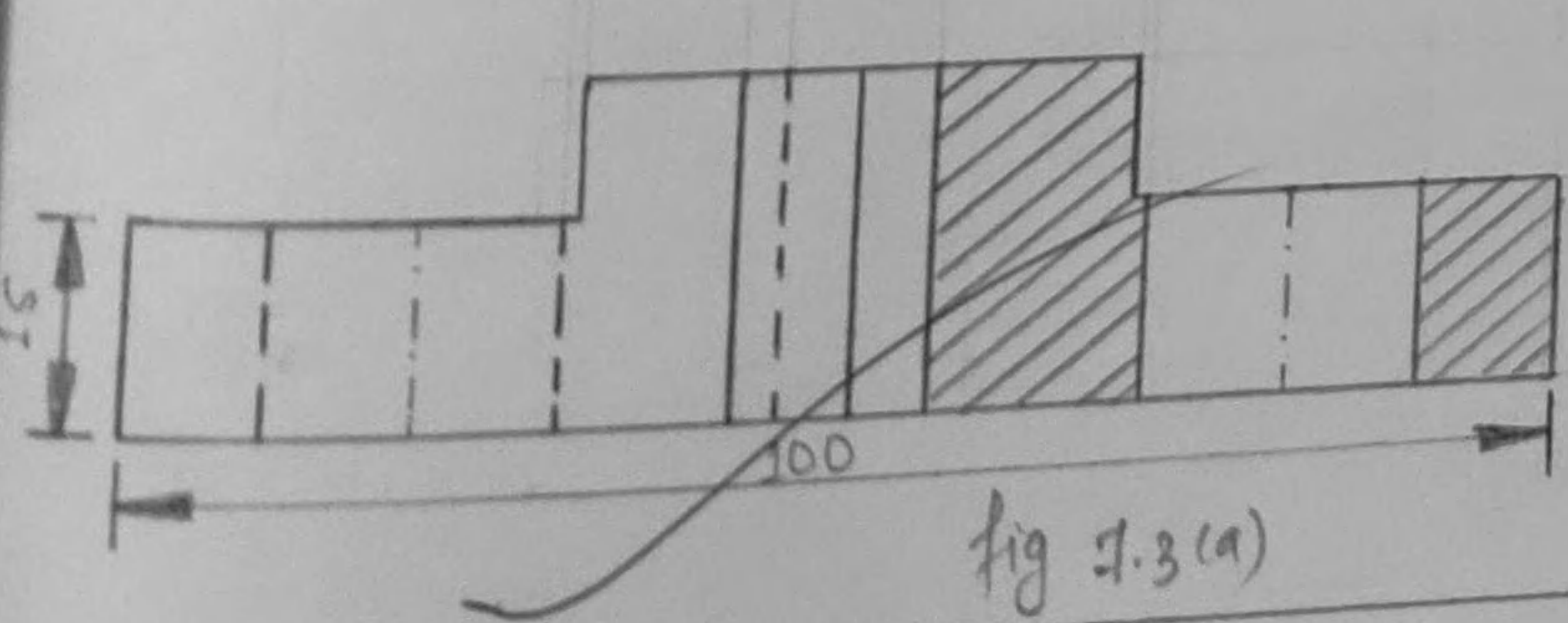
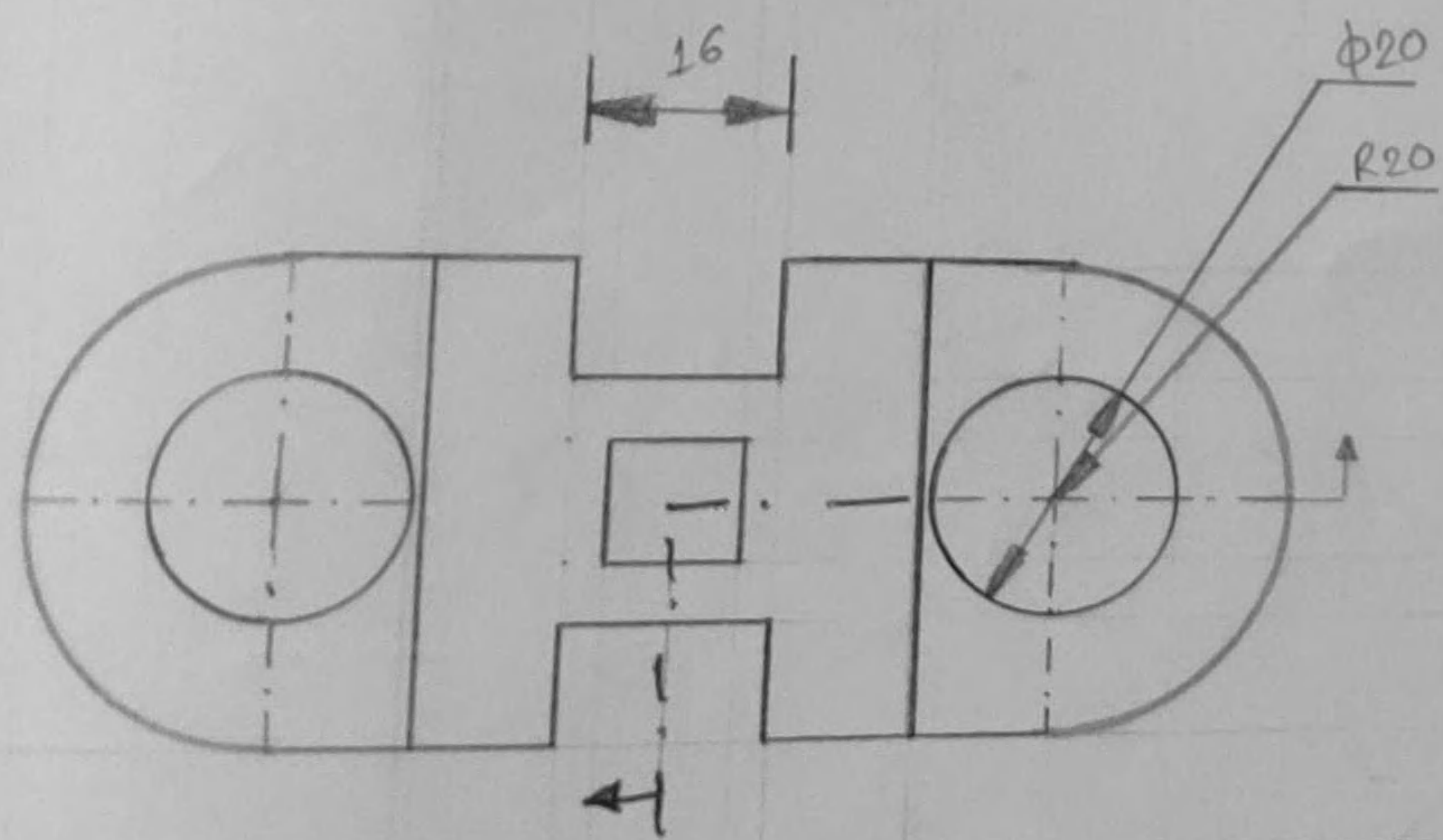
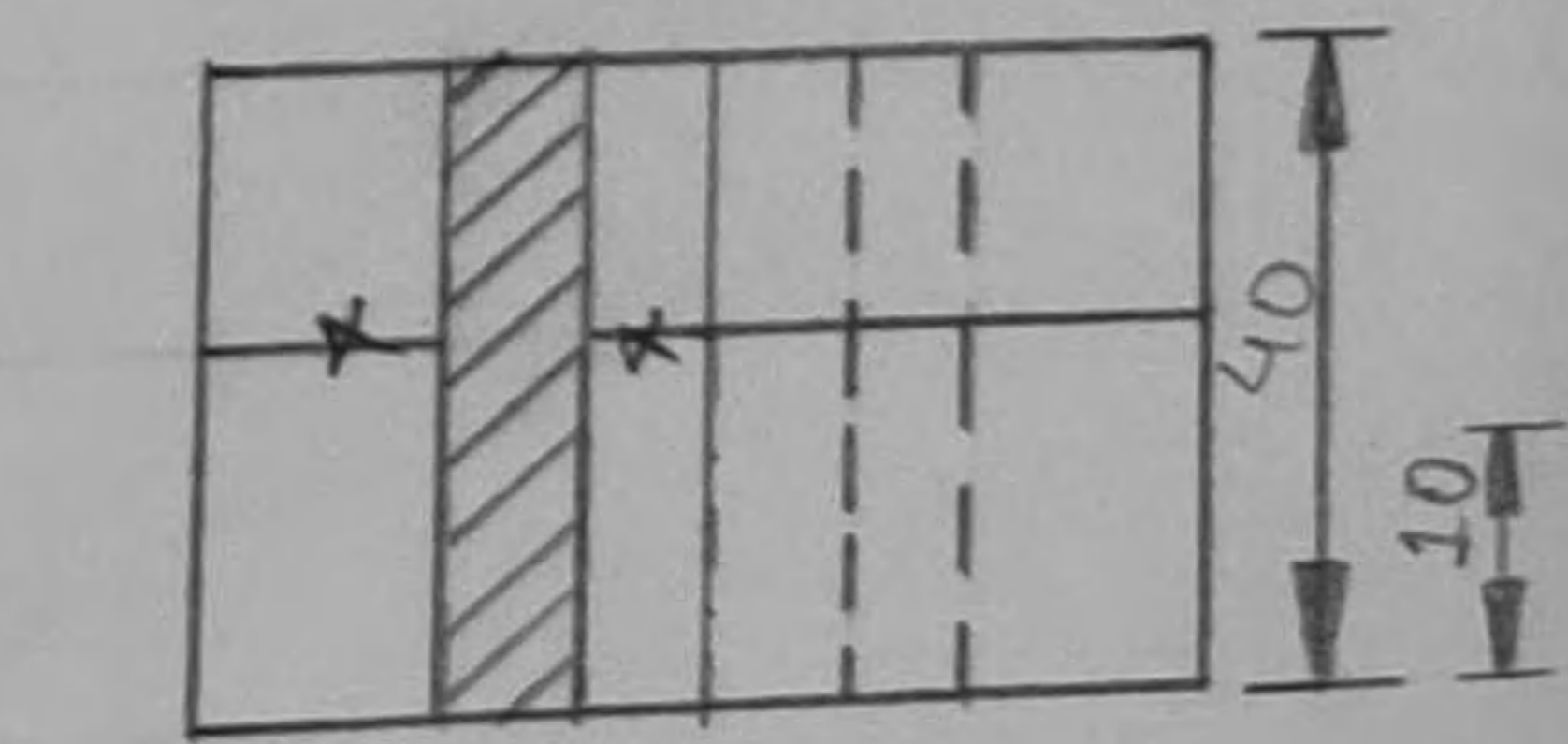

fig 7.3(a)



ca

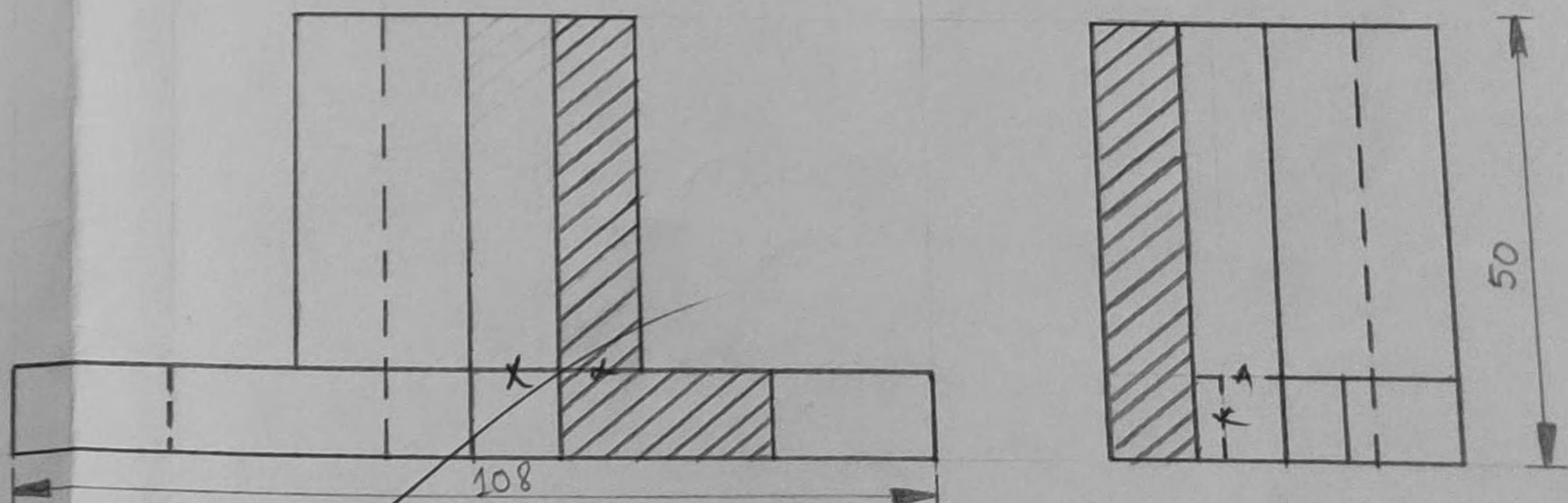
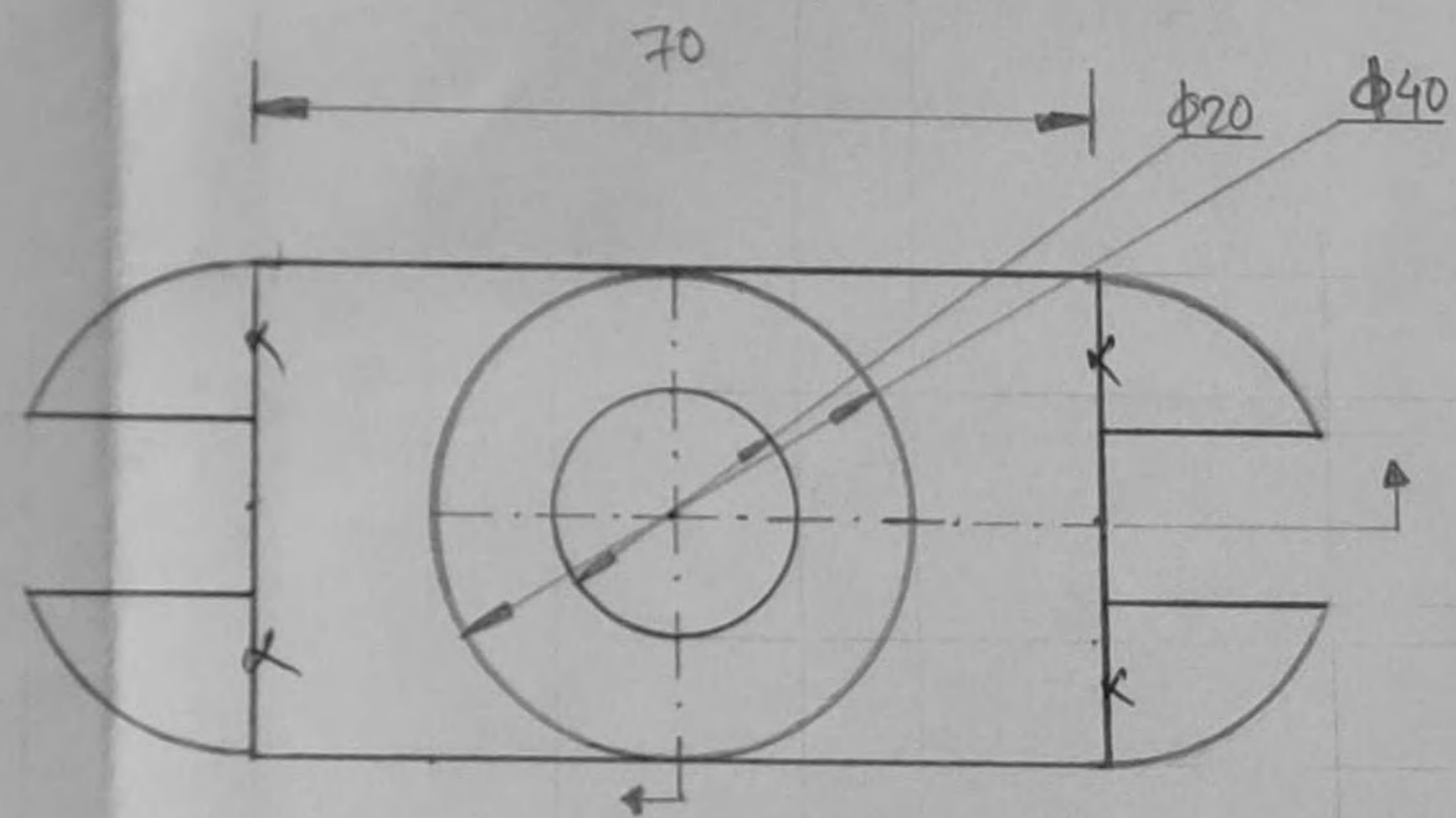

fig 8.7(b)

ca

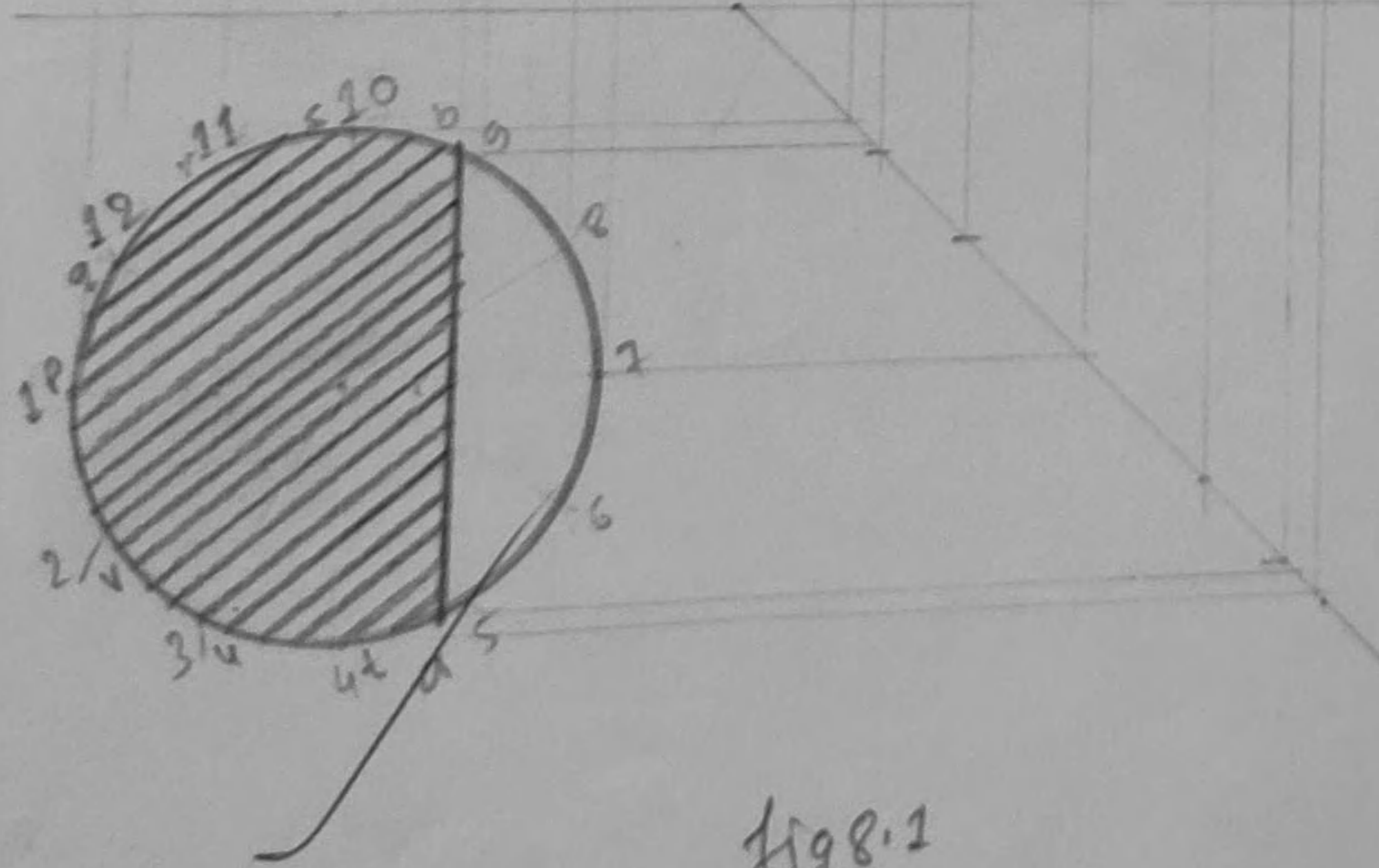
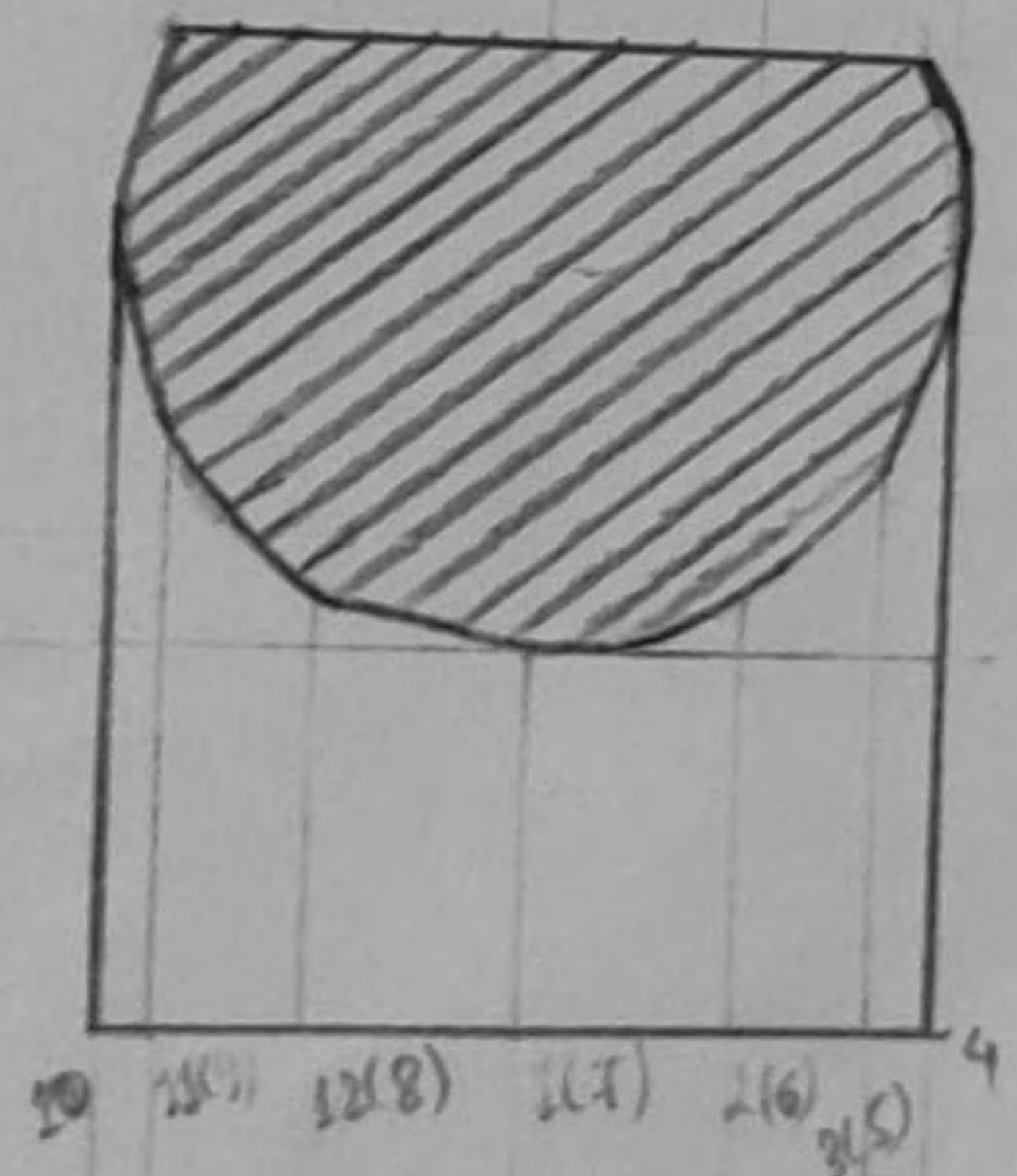
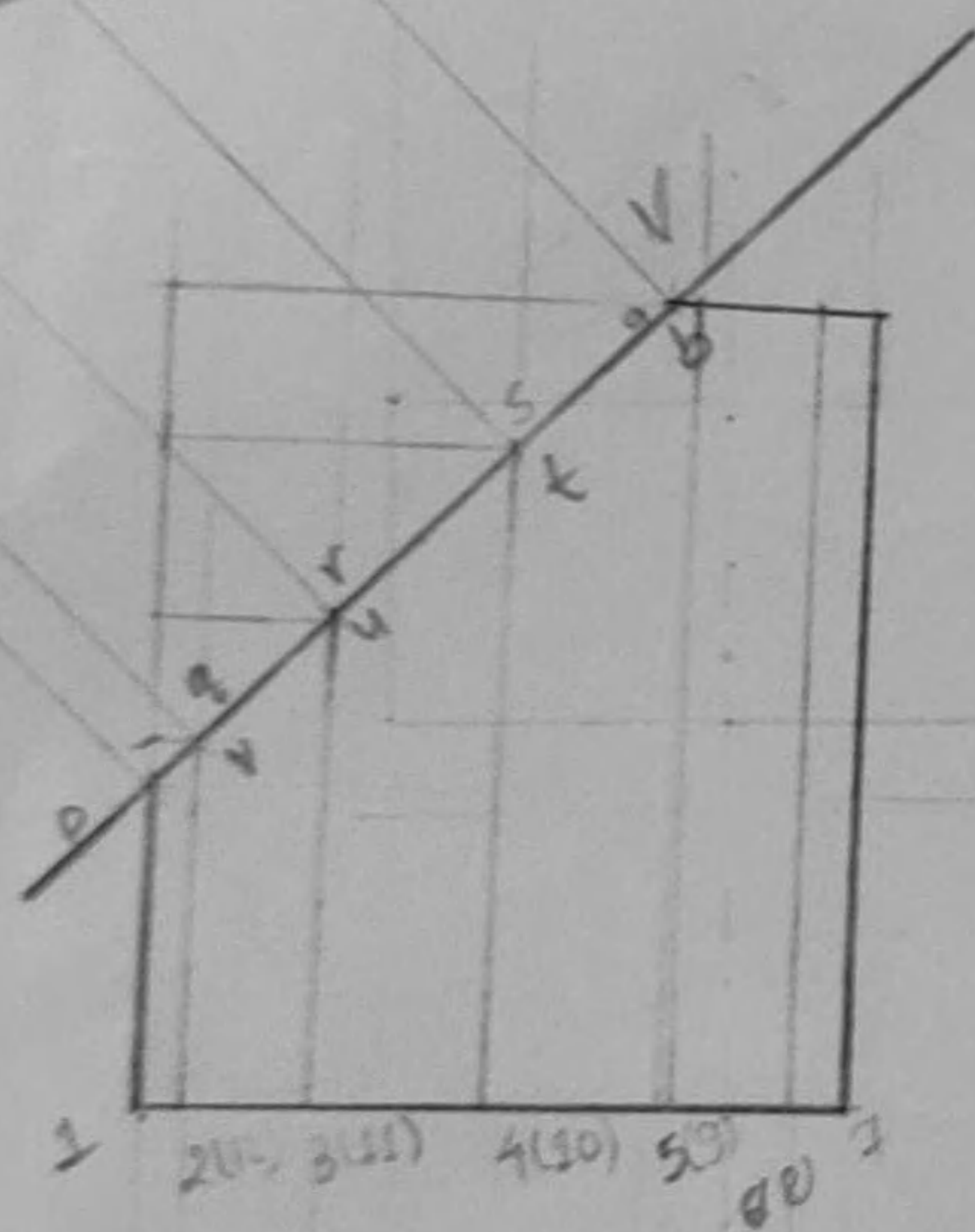
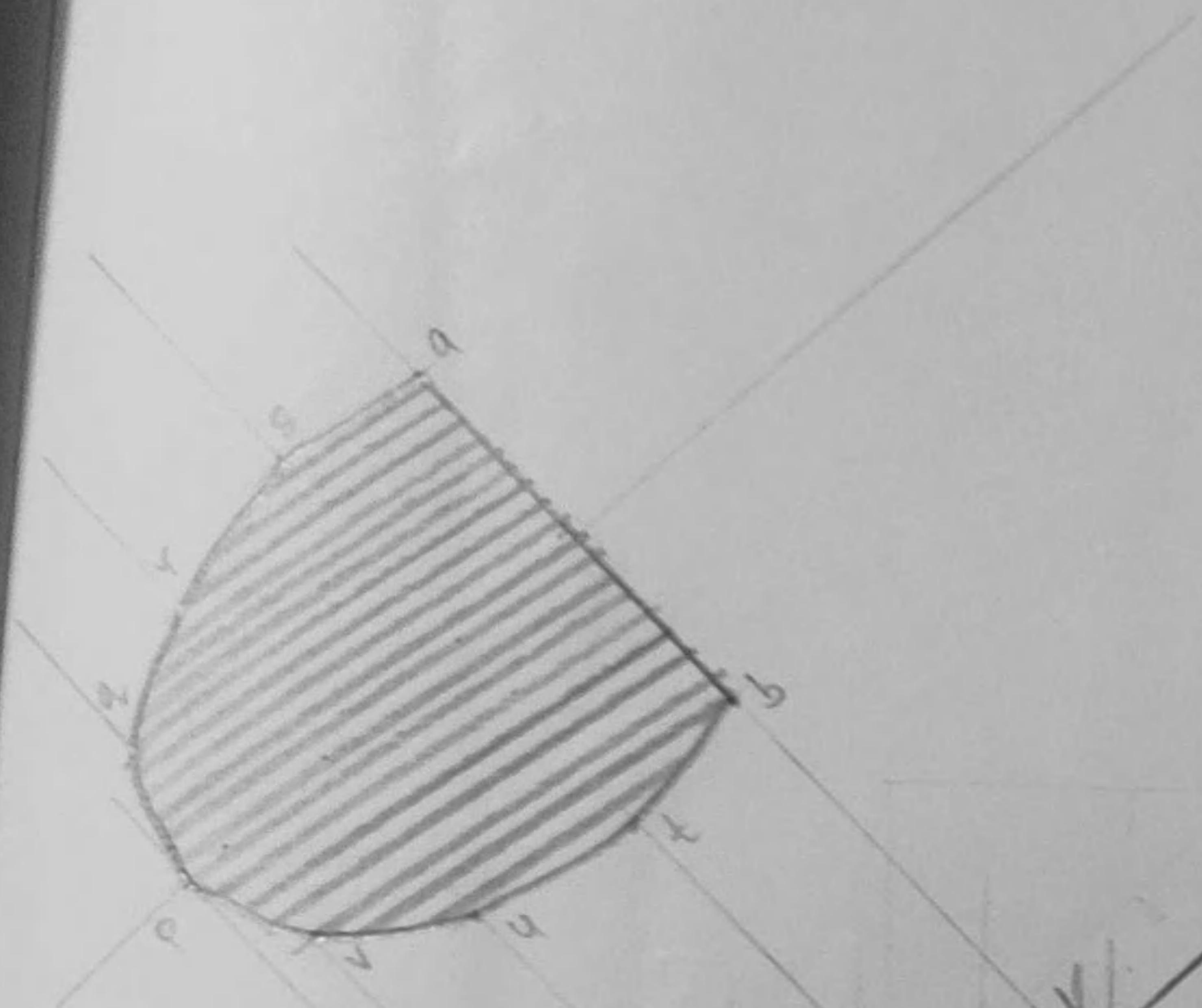
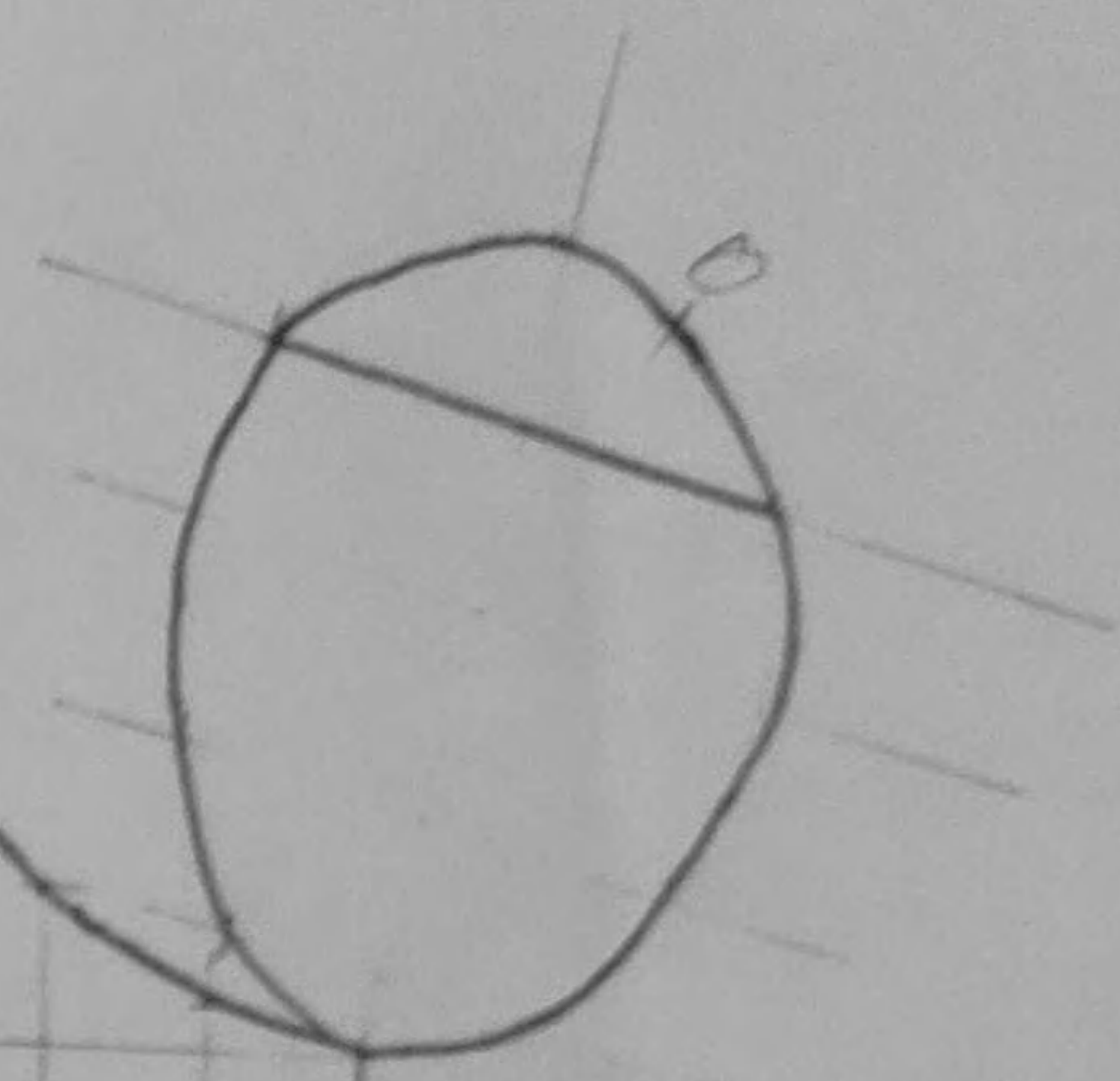
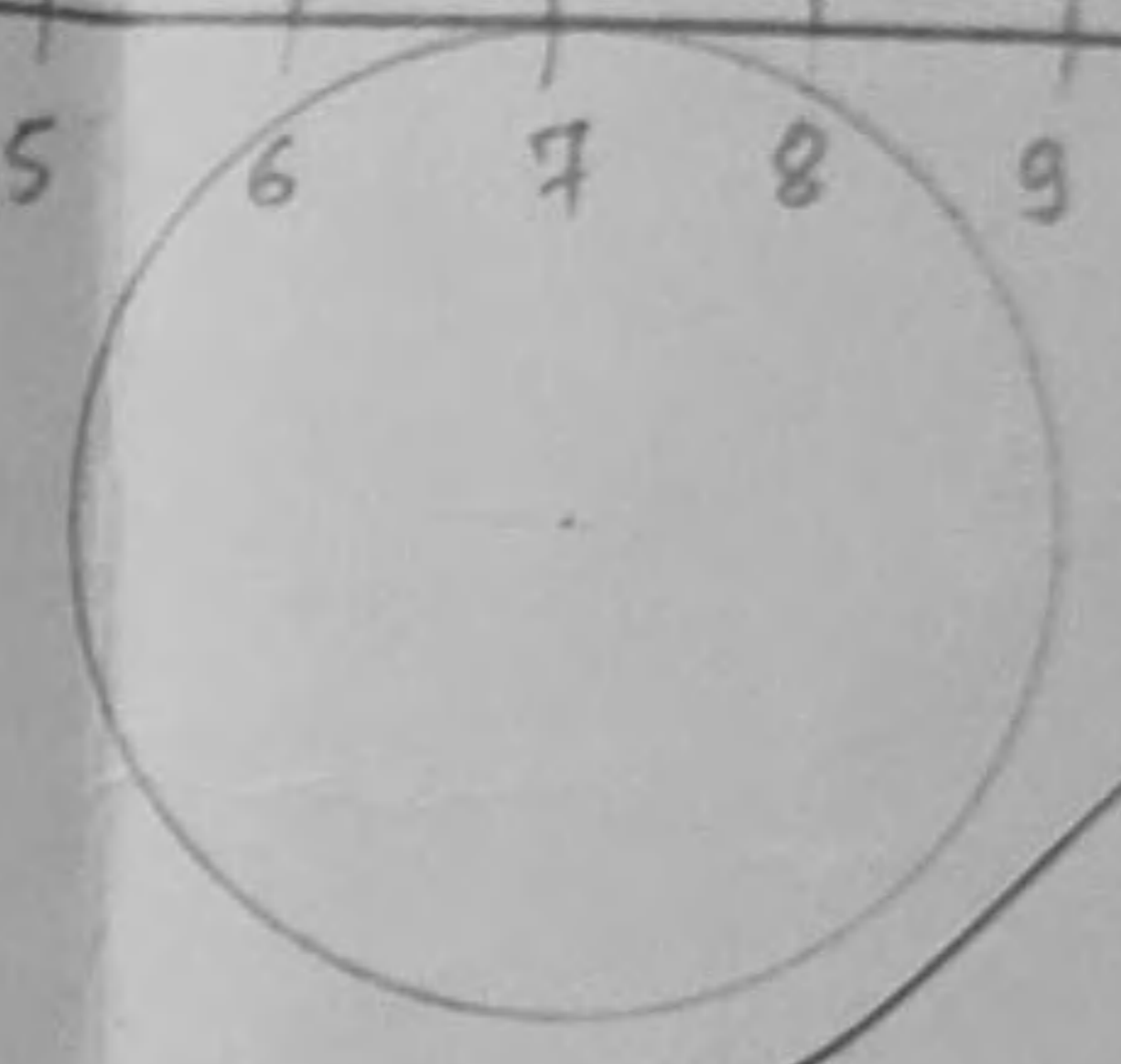
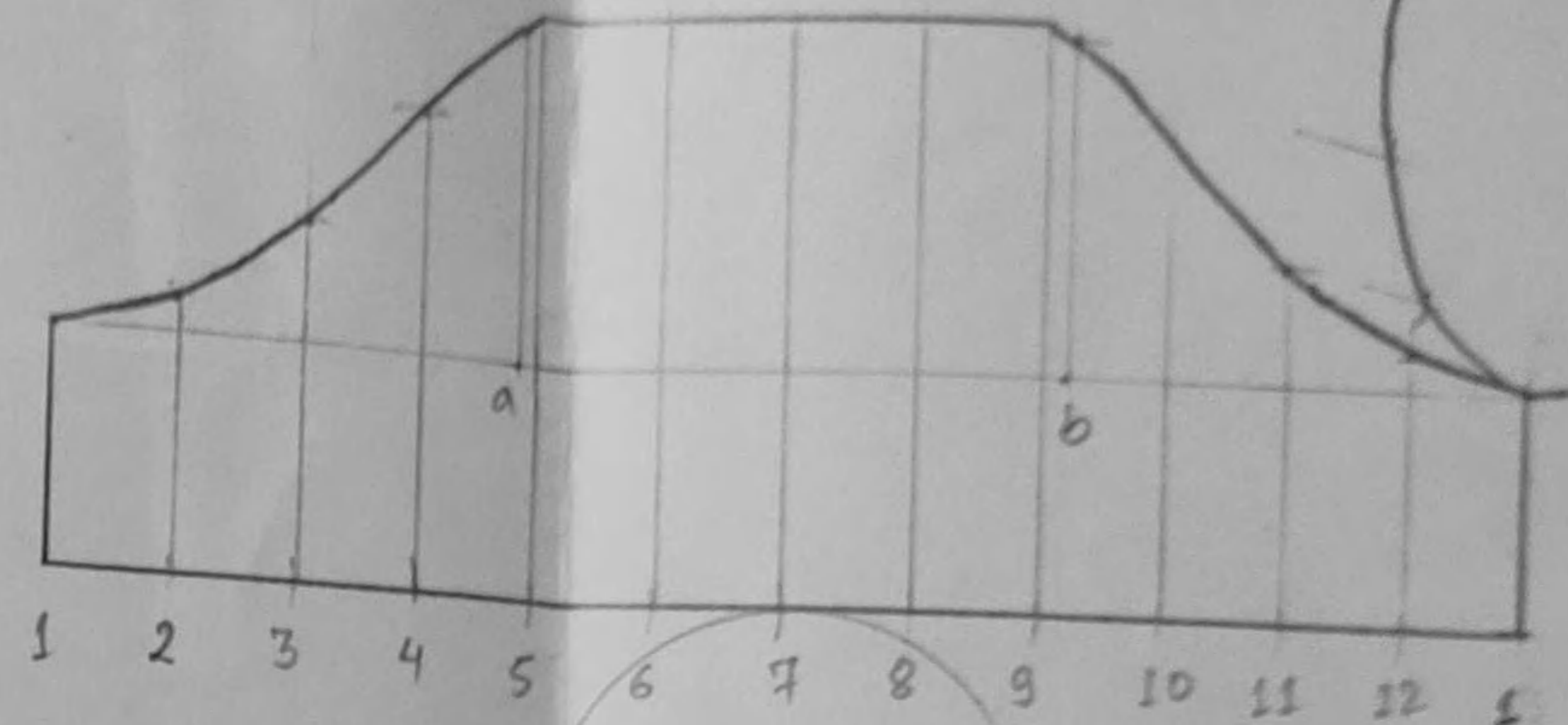

Fig 8.1



to

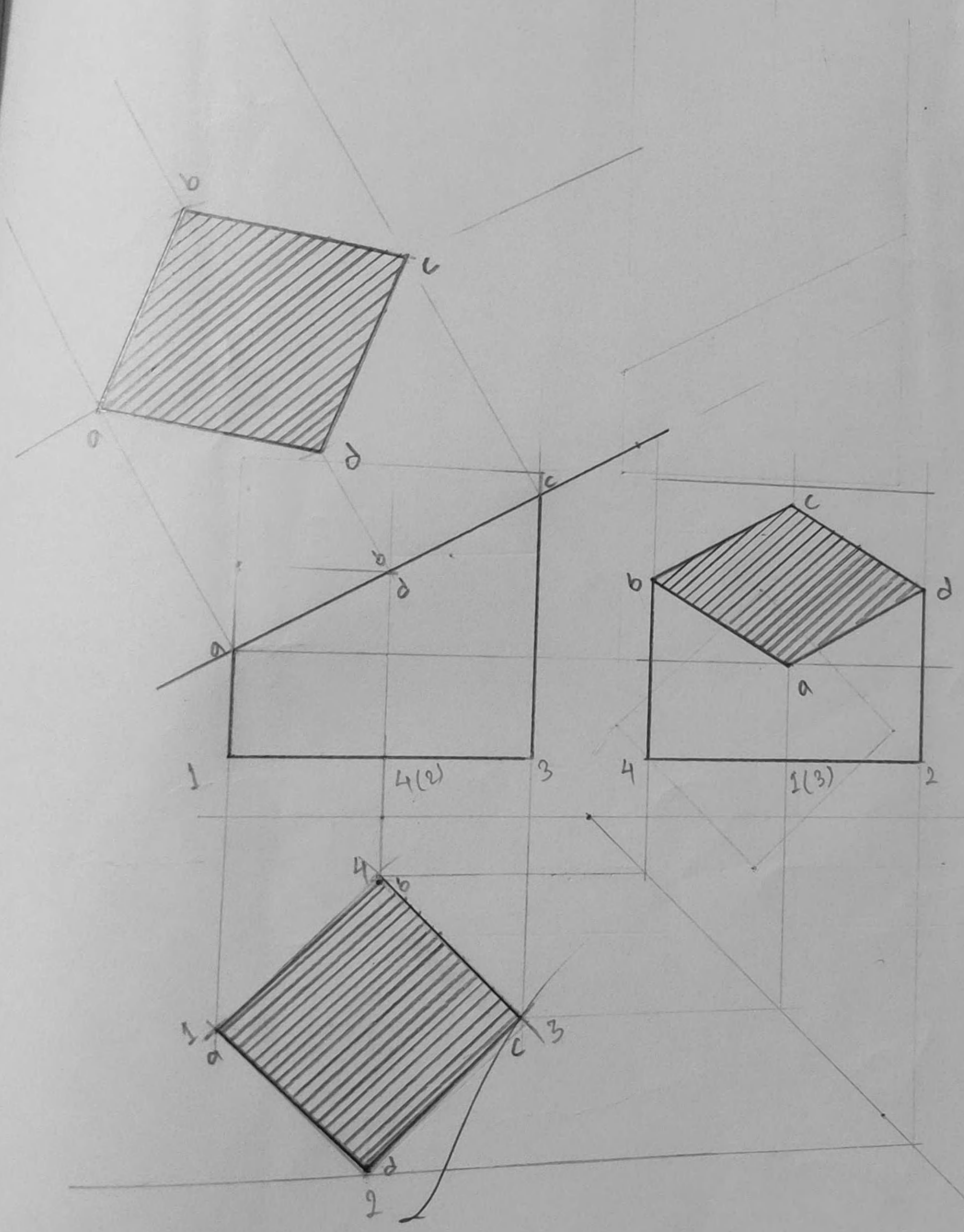
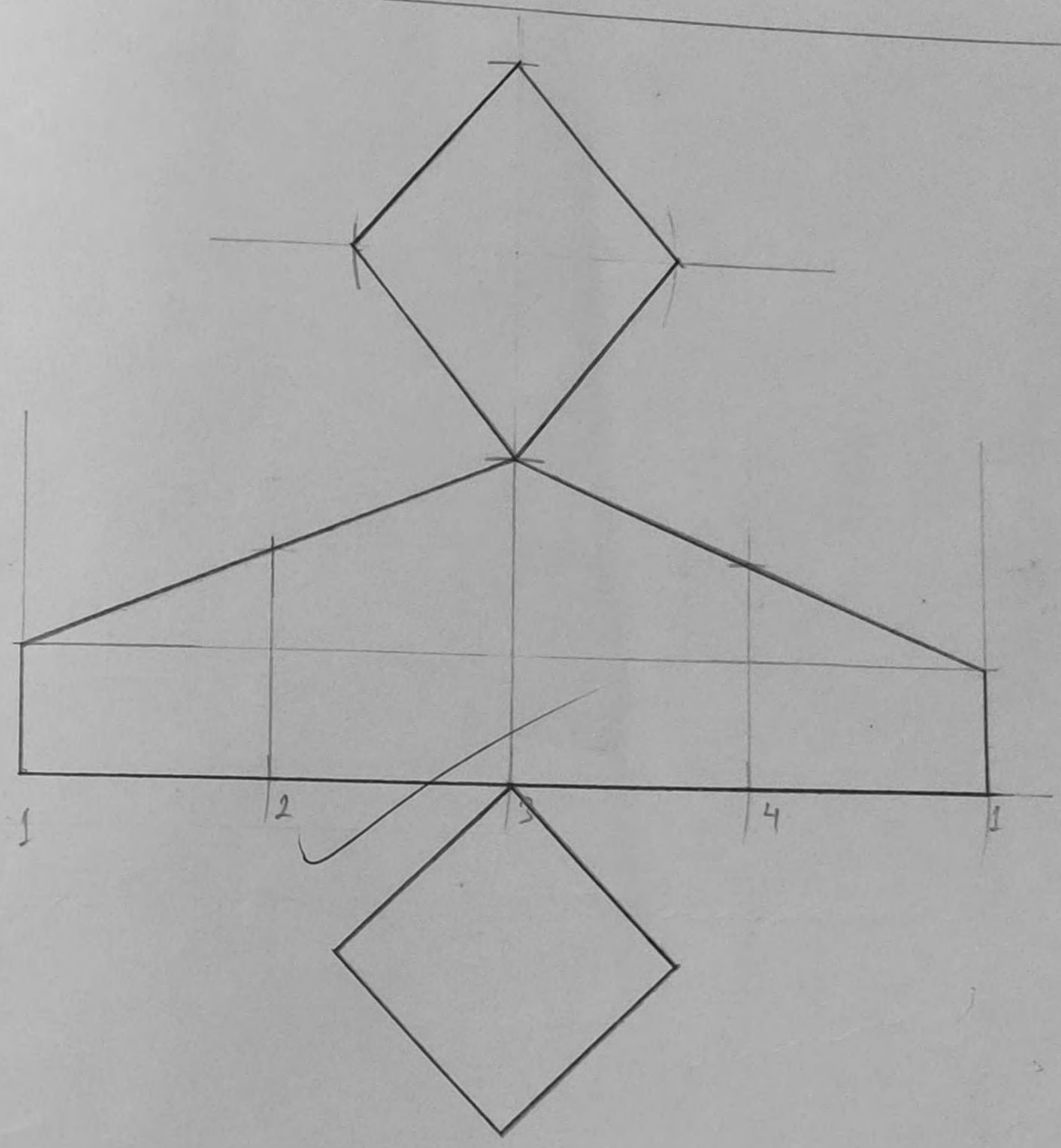
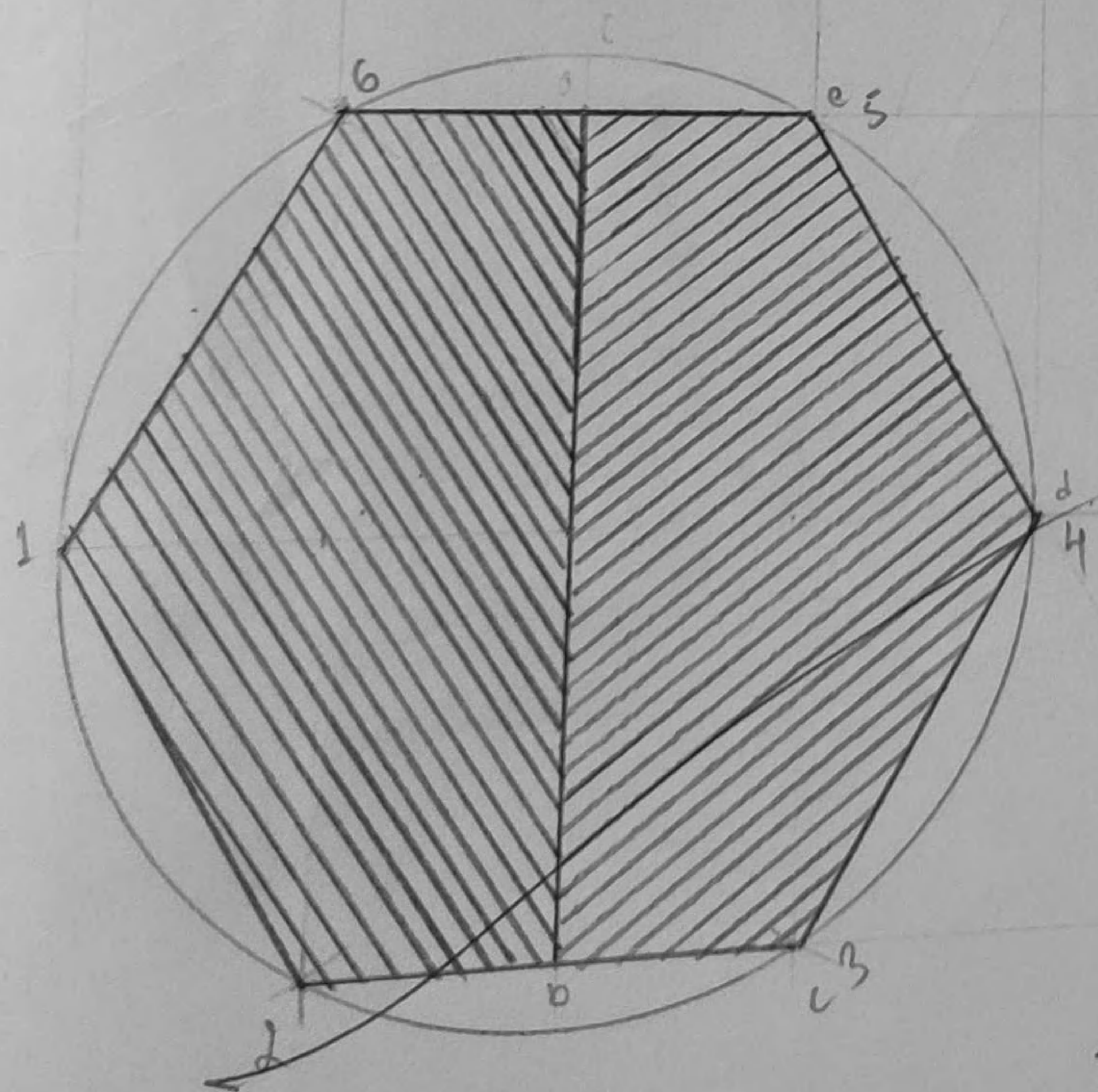
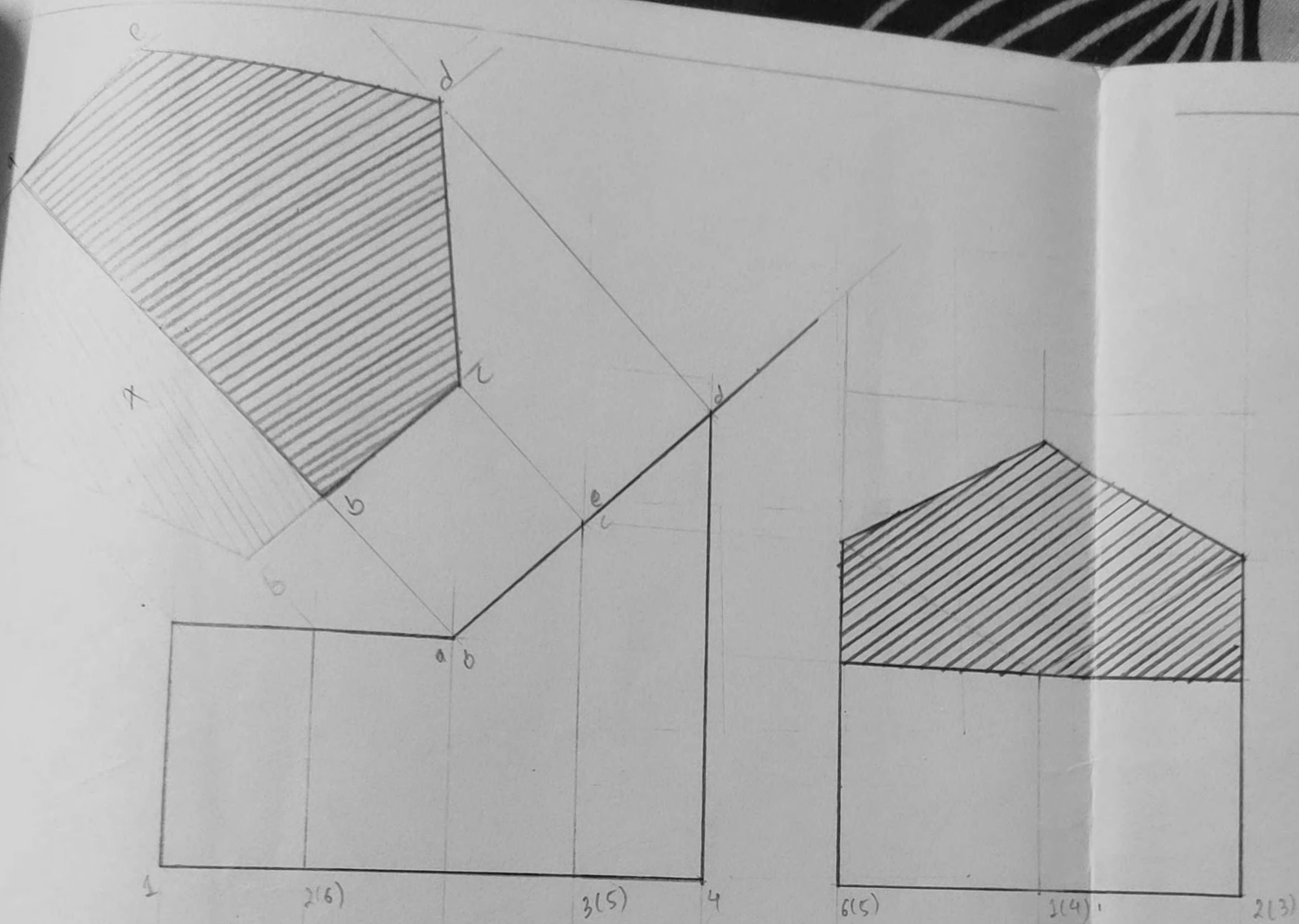

fig 8.2



ex



204

fig 8.3

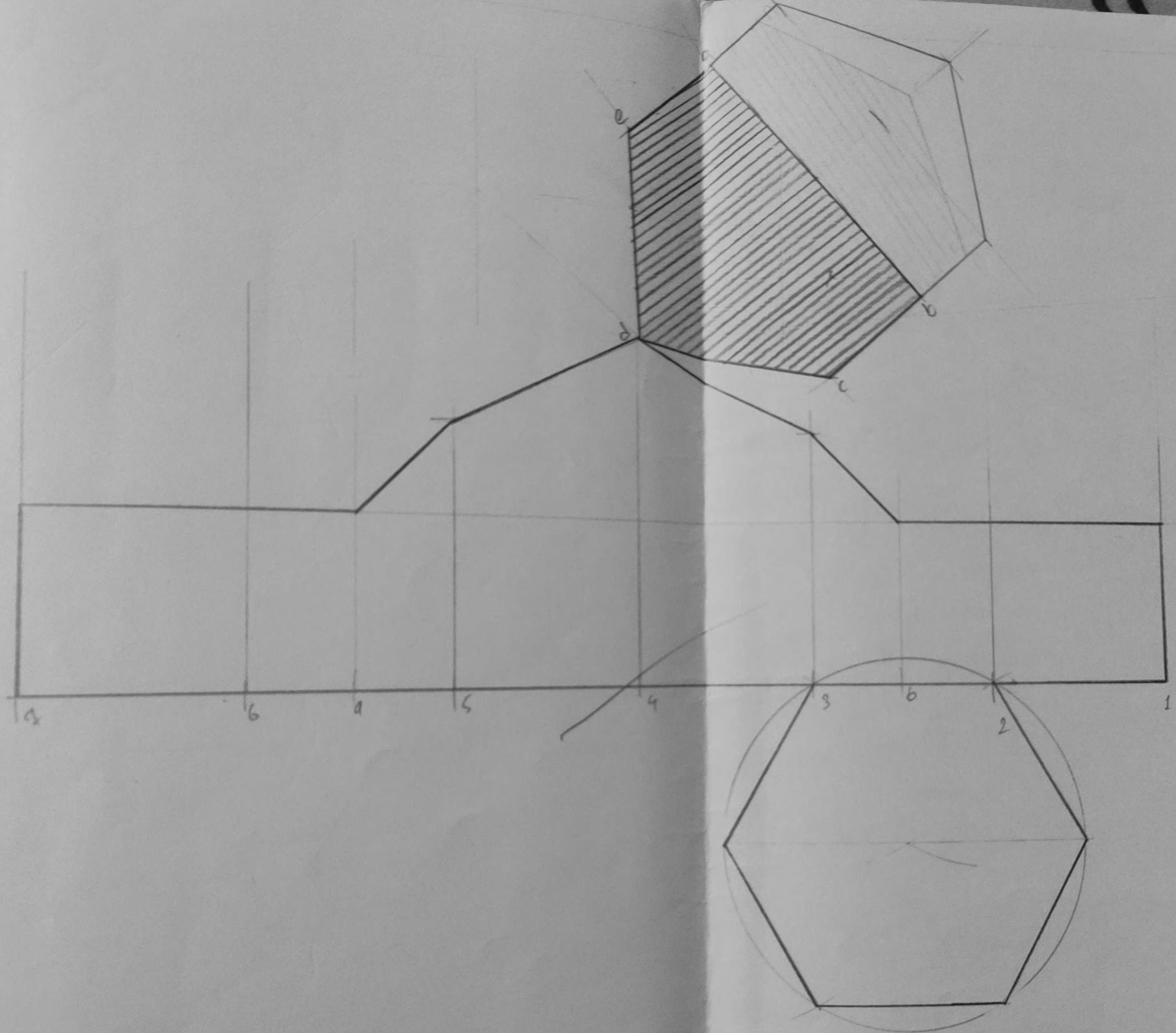

fig 8.3

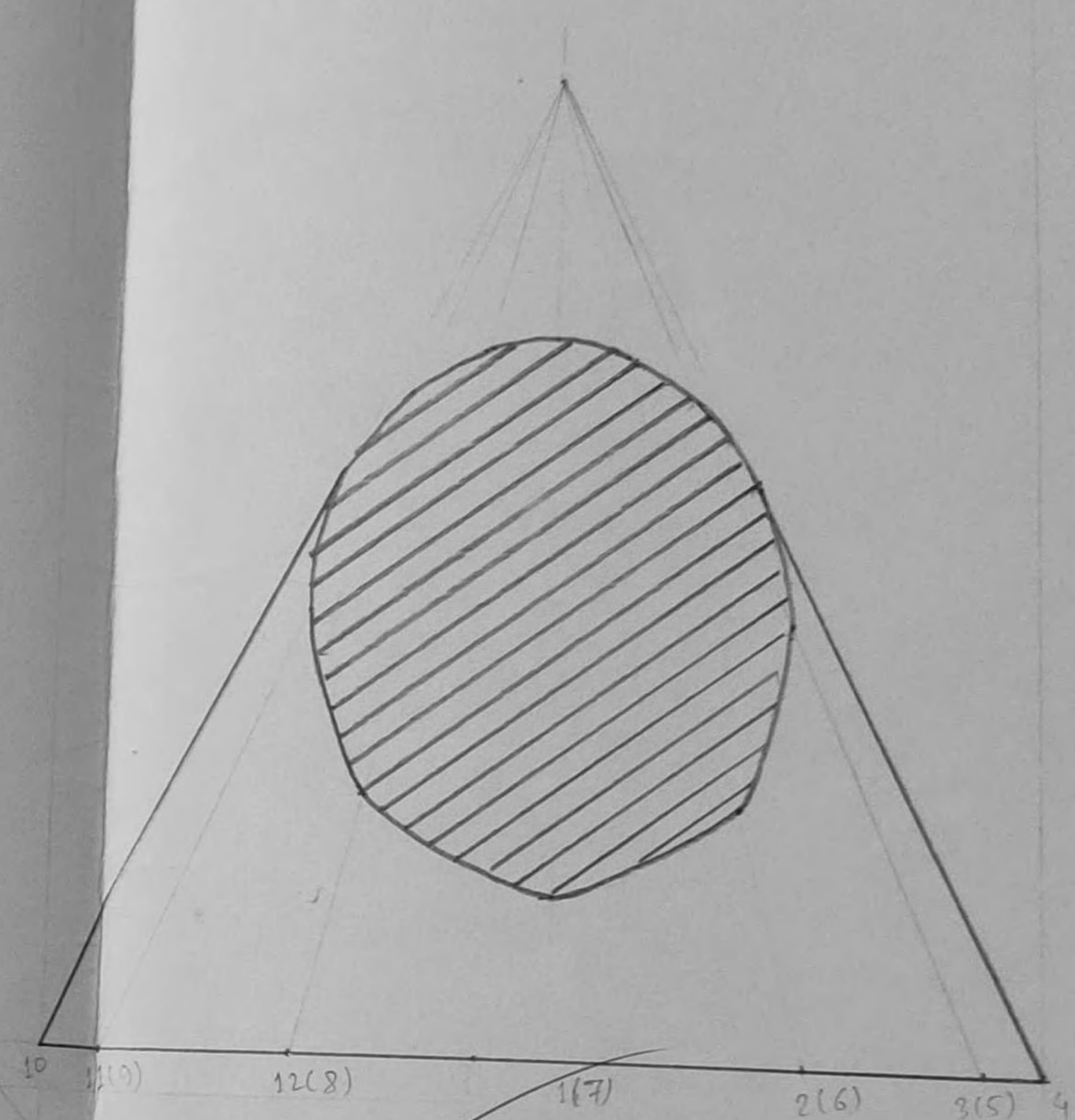
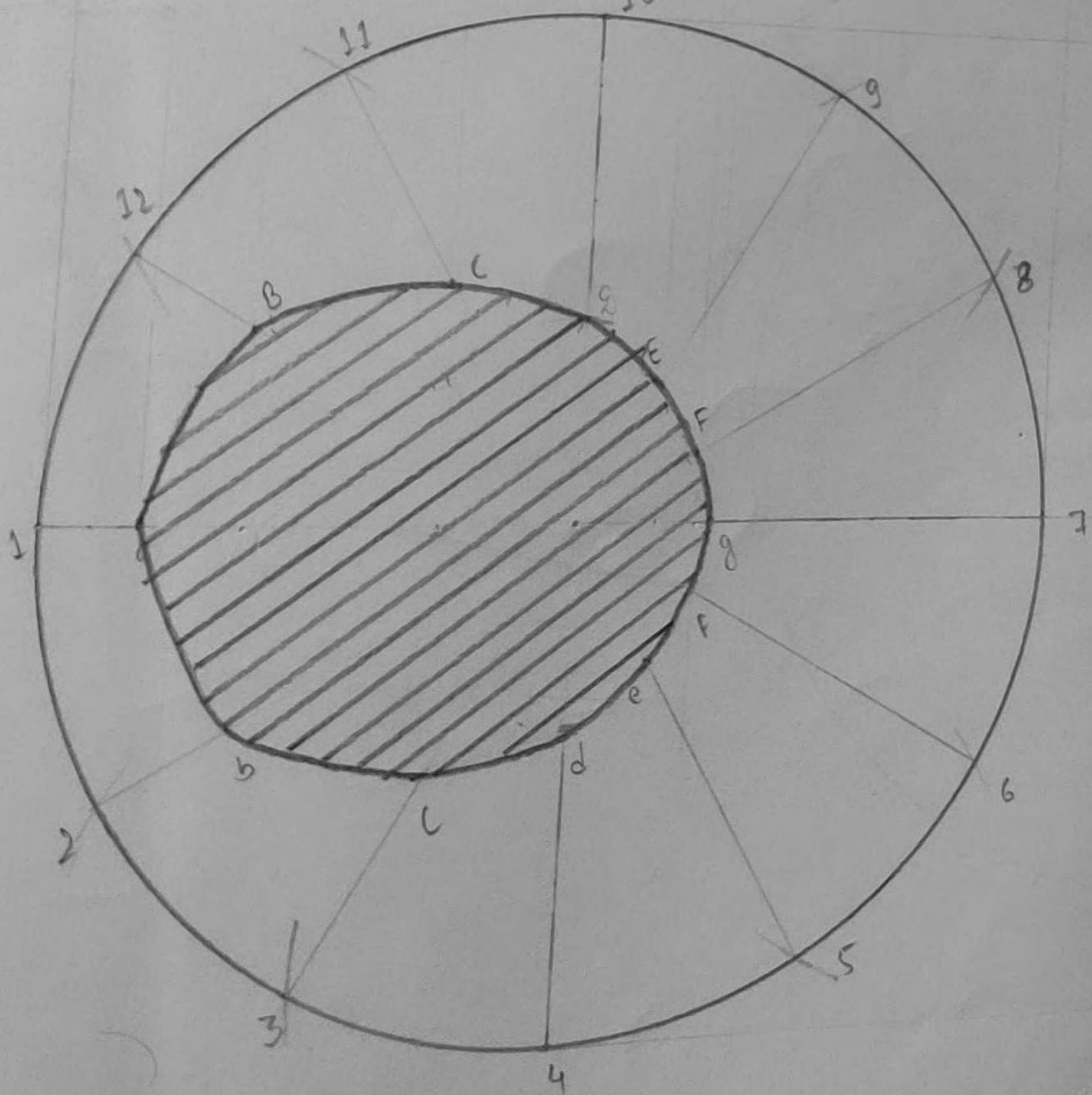
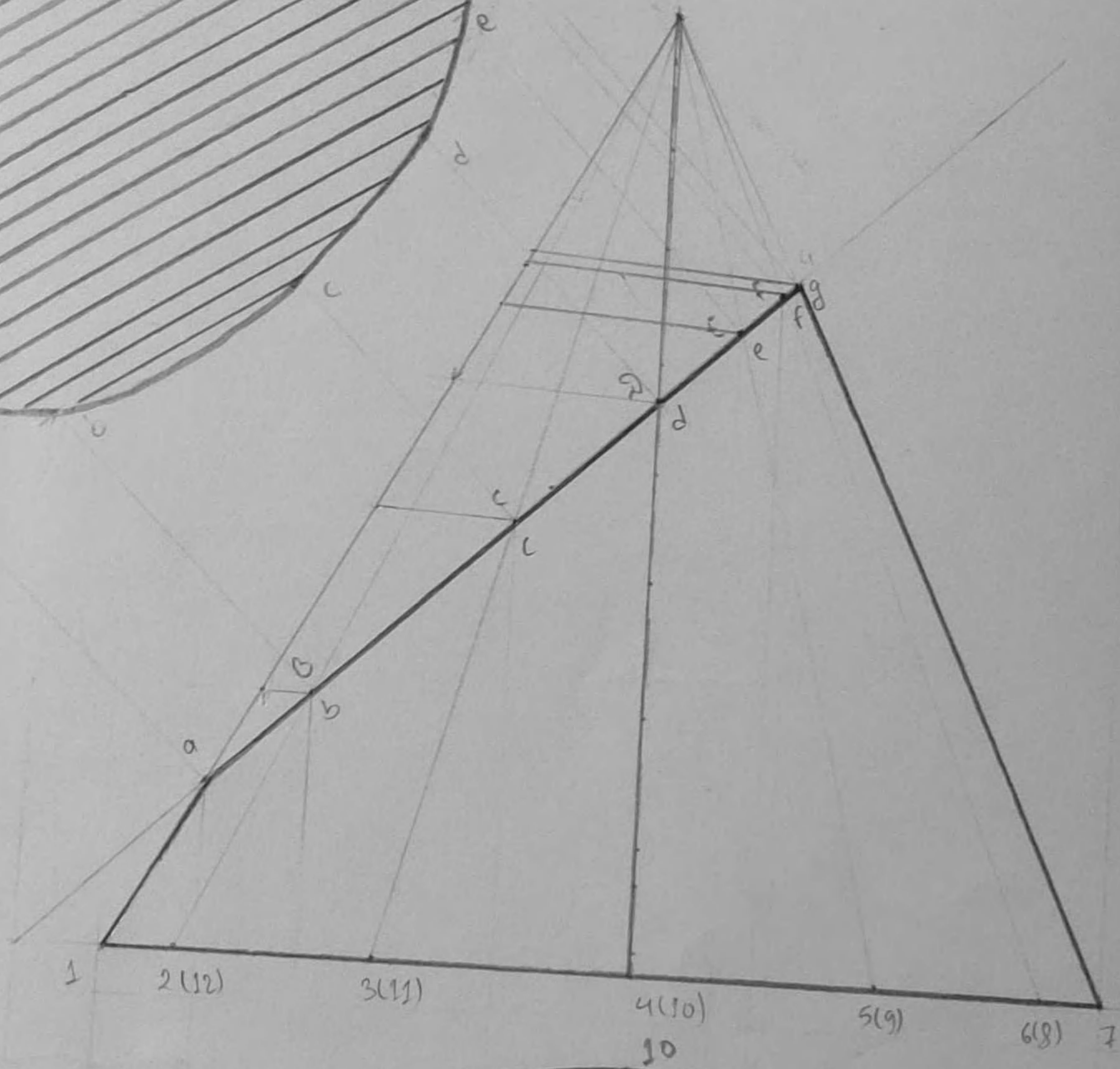
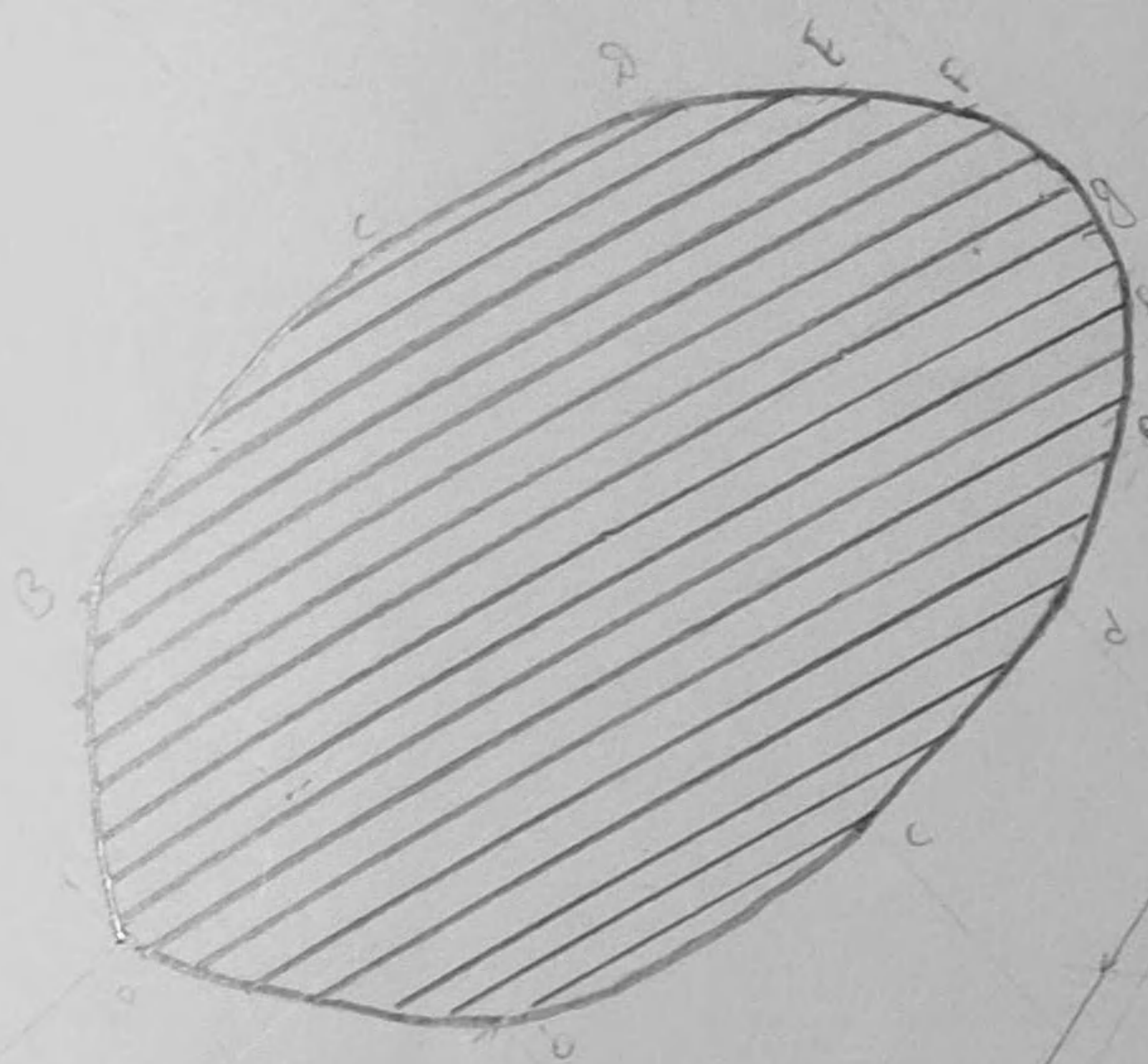

fig 8.4

Handwritten scribble or signature.

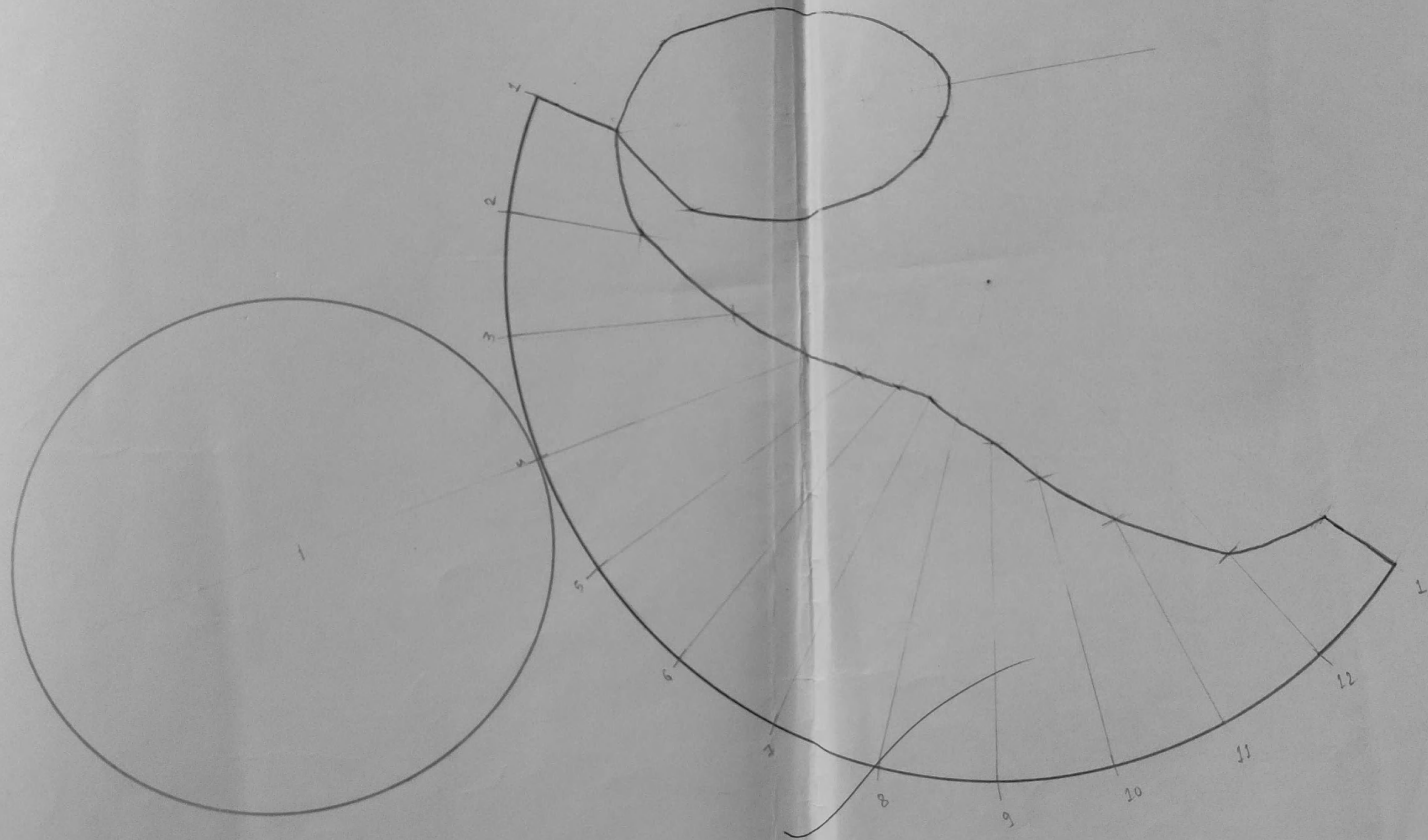
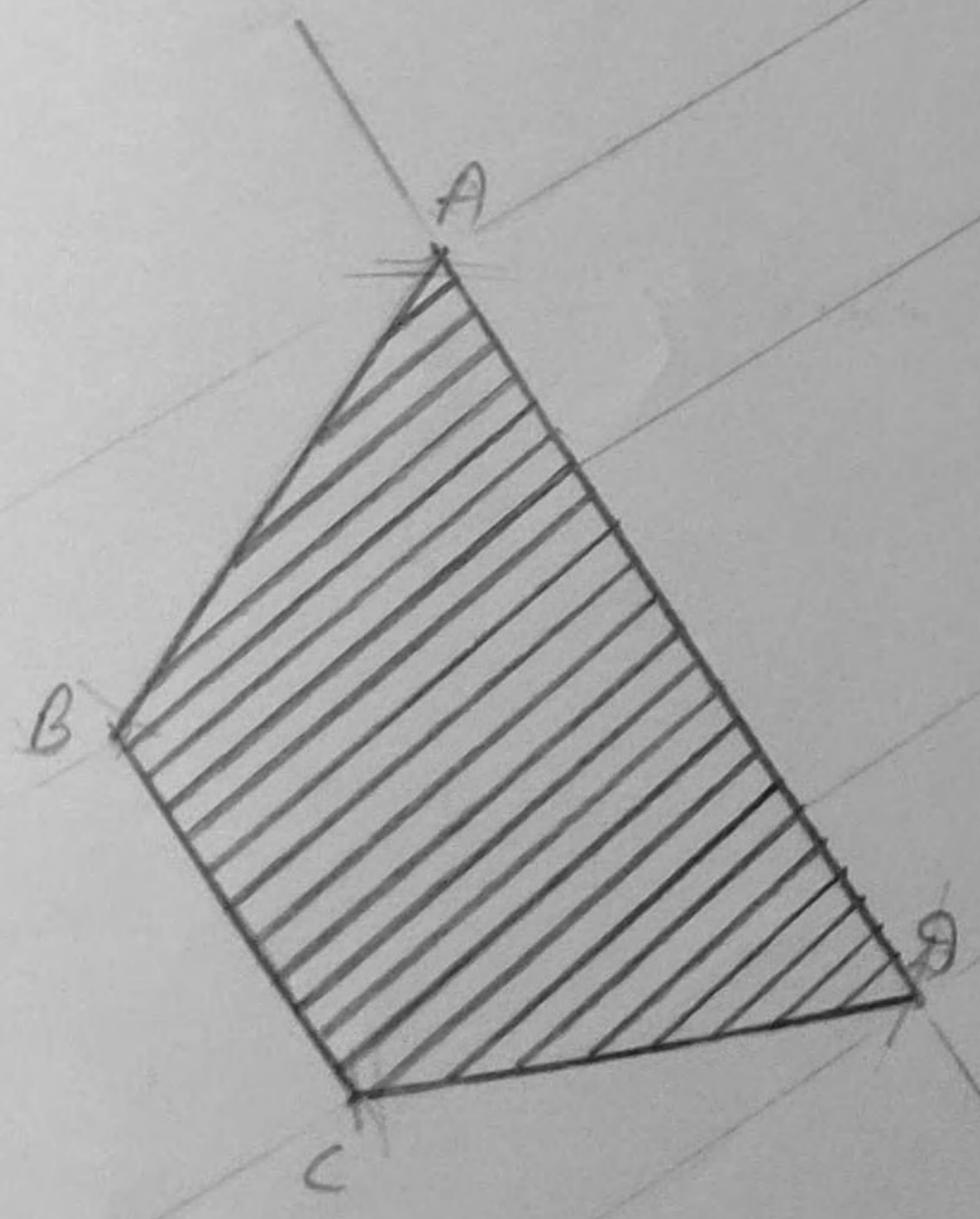
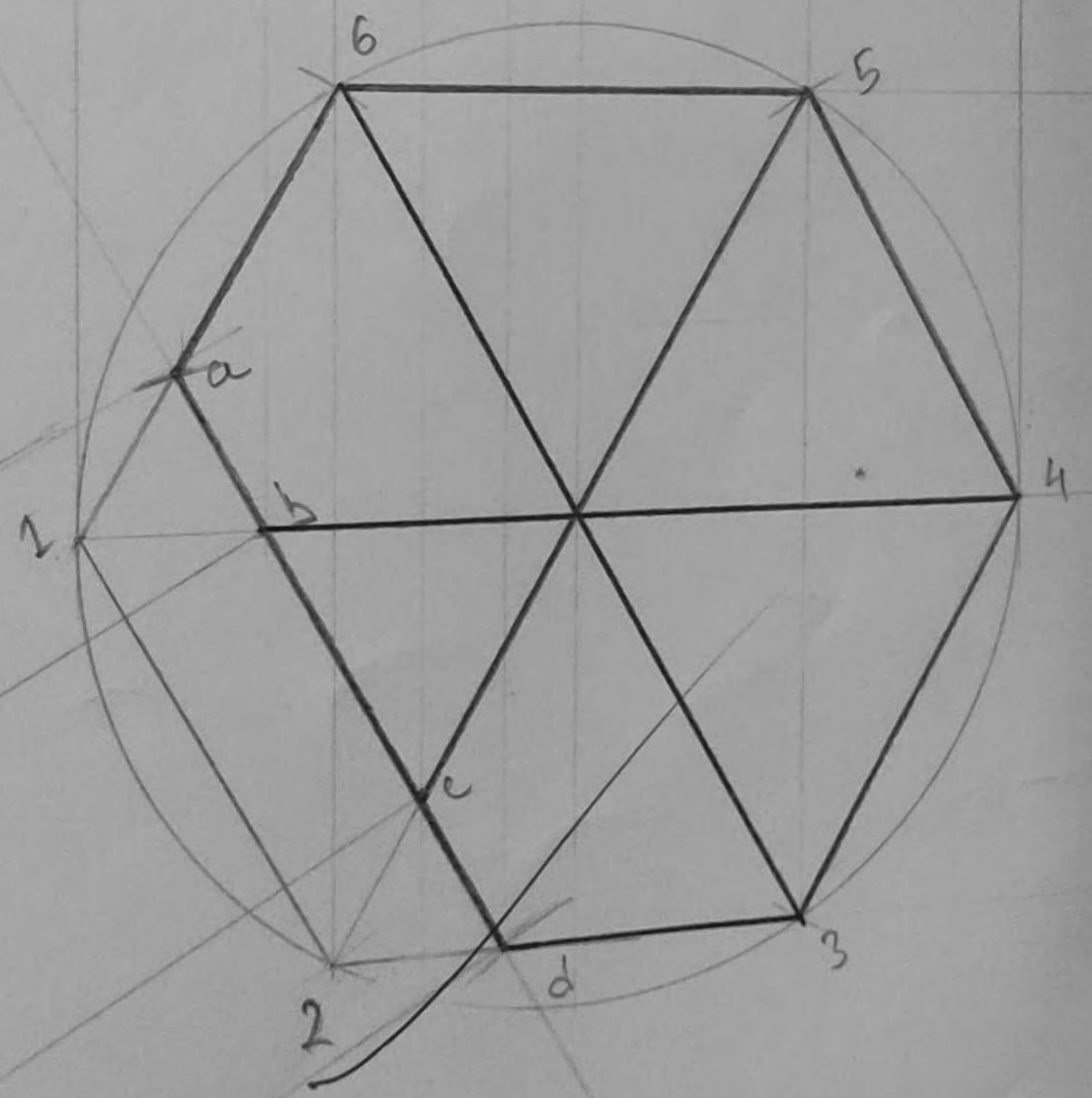
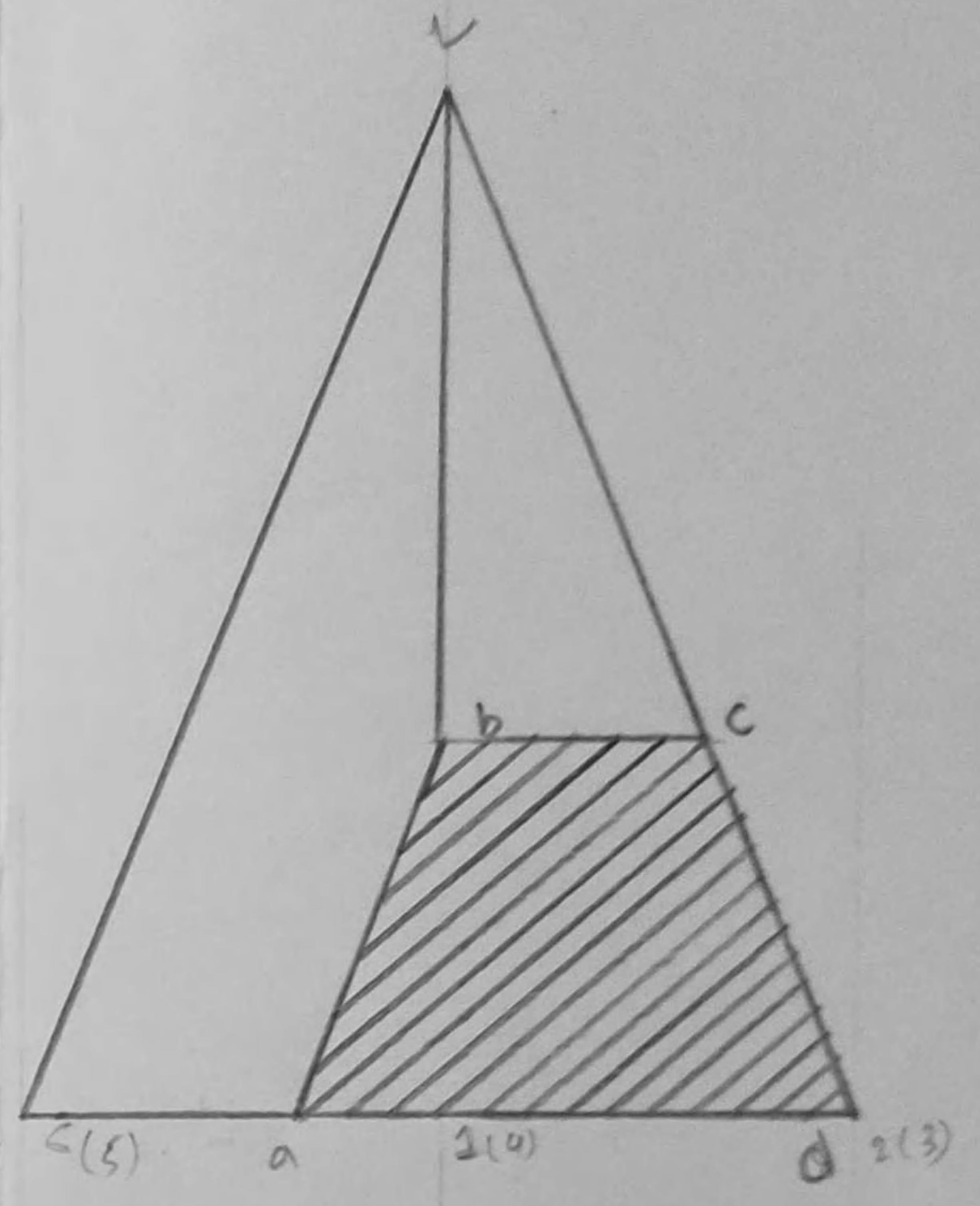
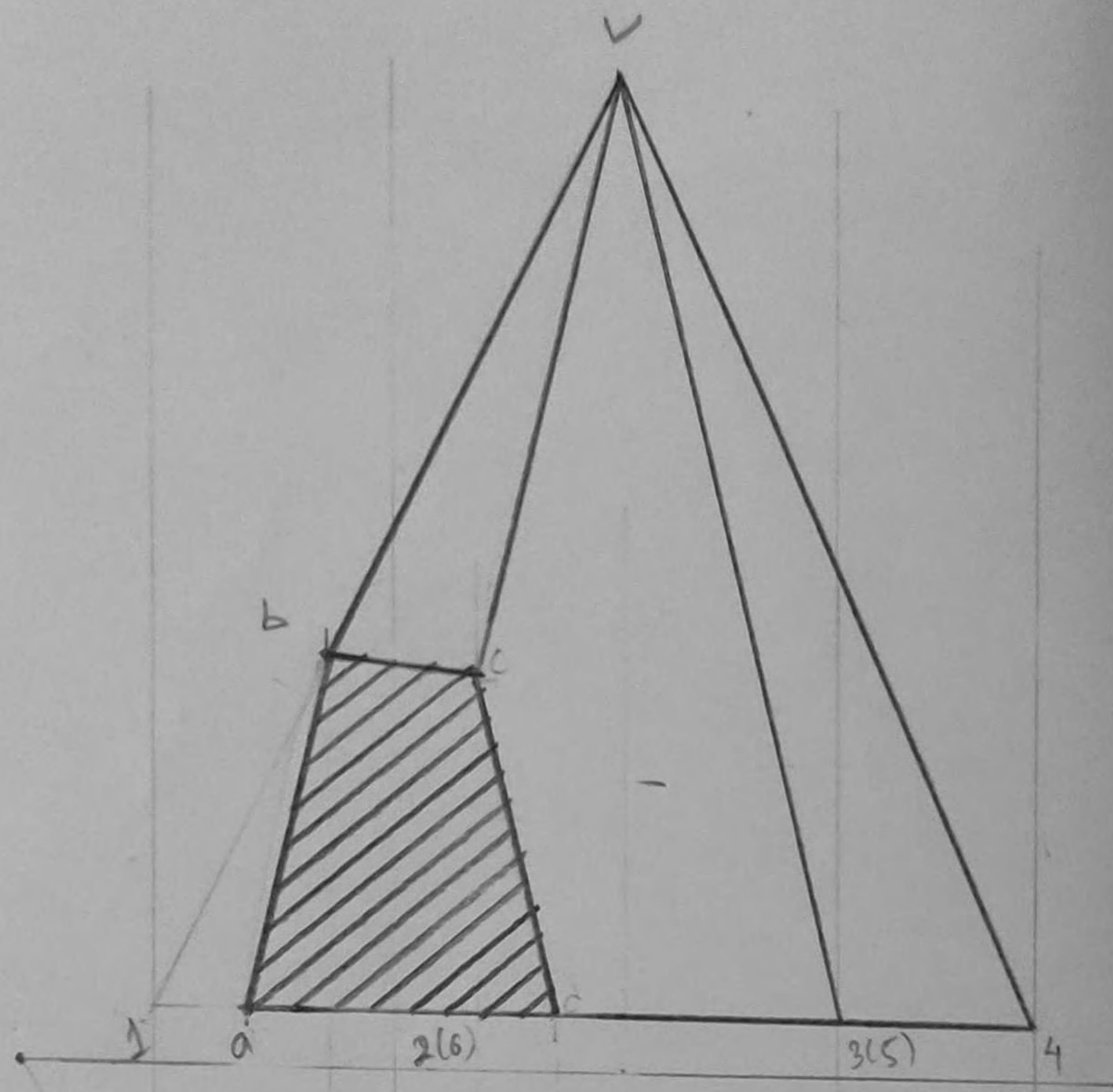
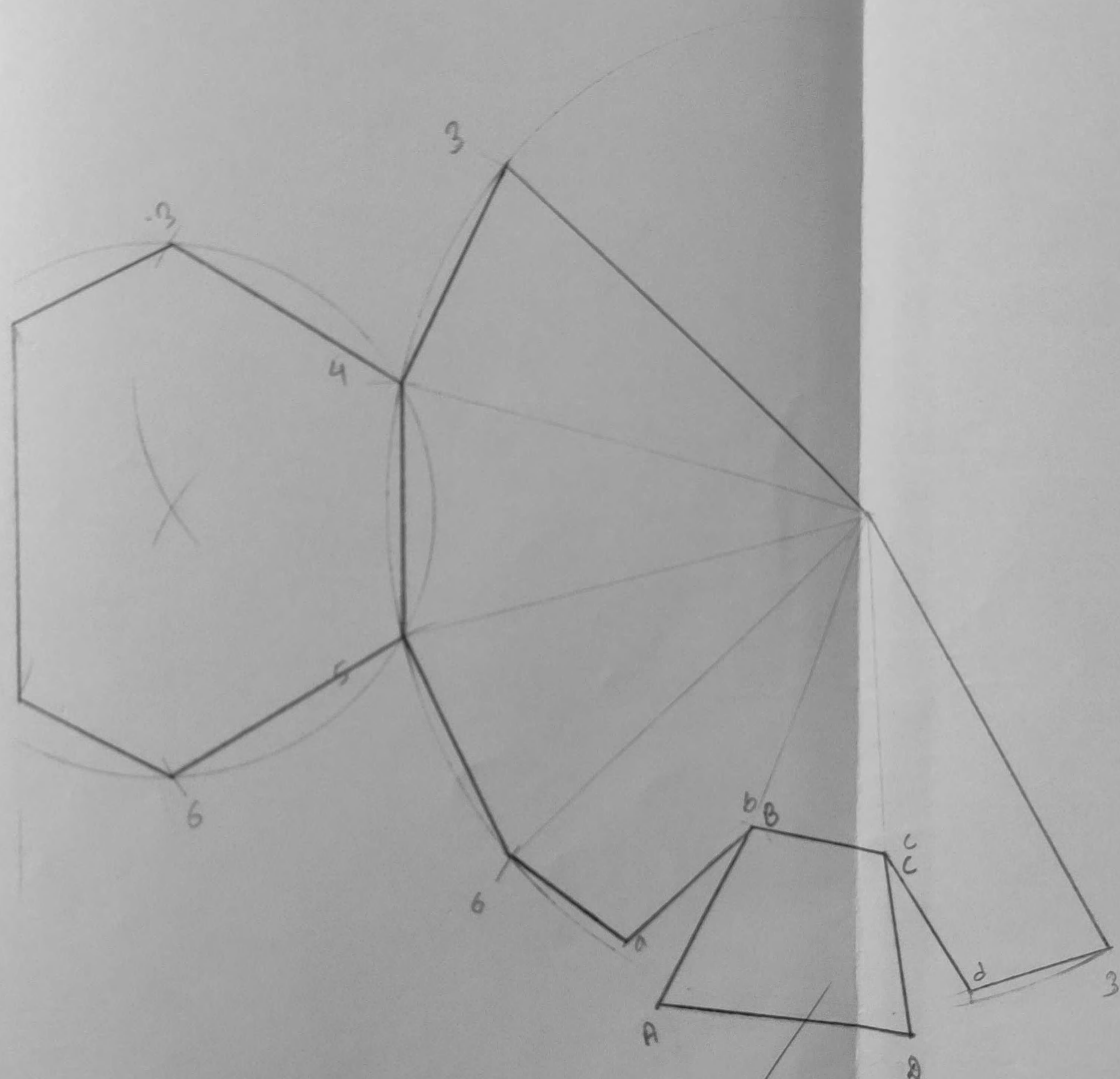

Fig 8.4



Co

Fig 8.5



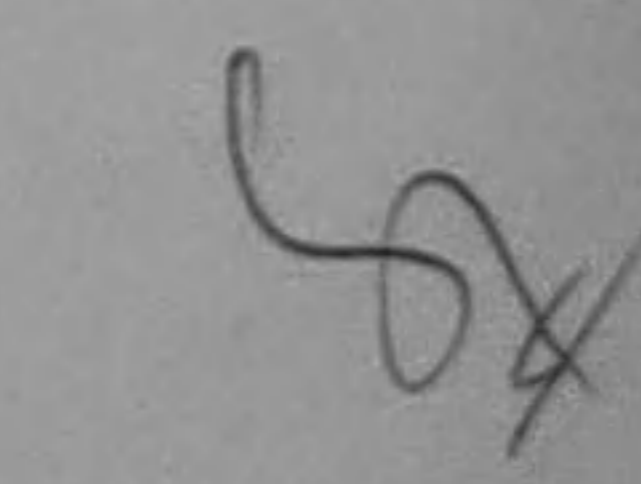

fig 8.5

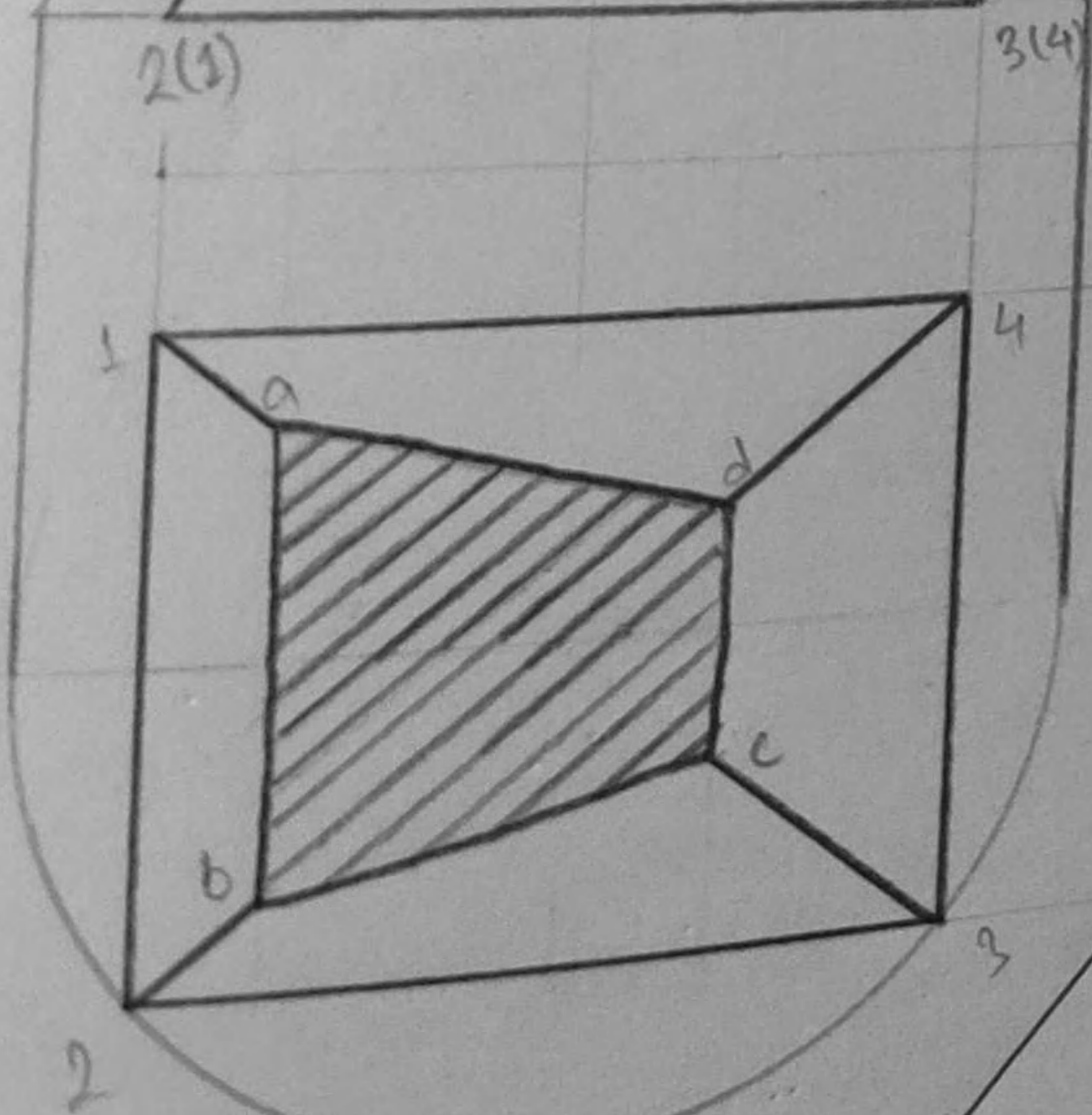
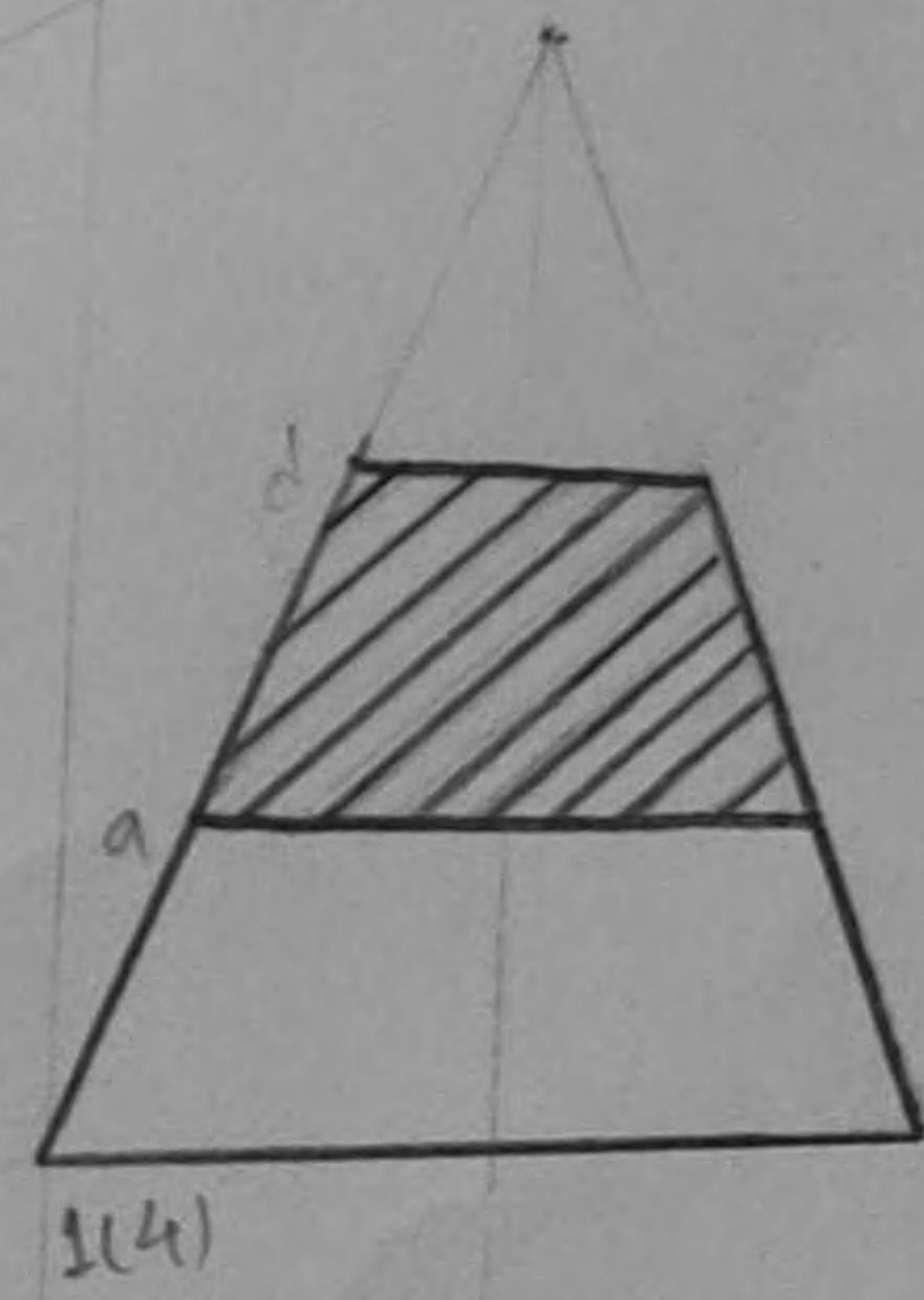
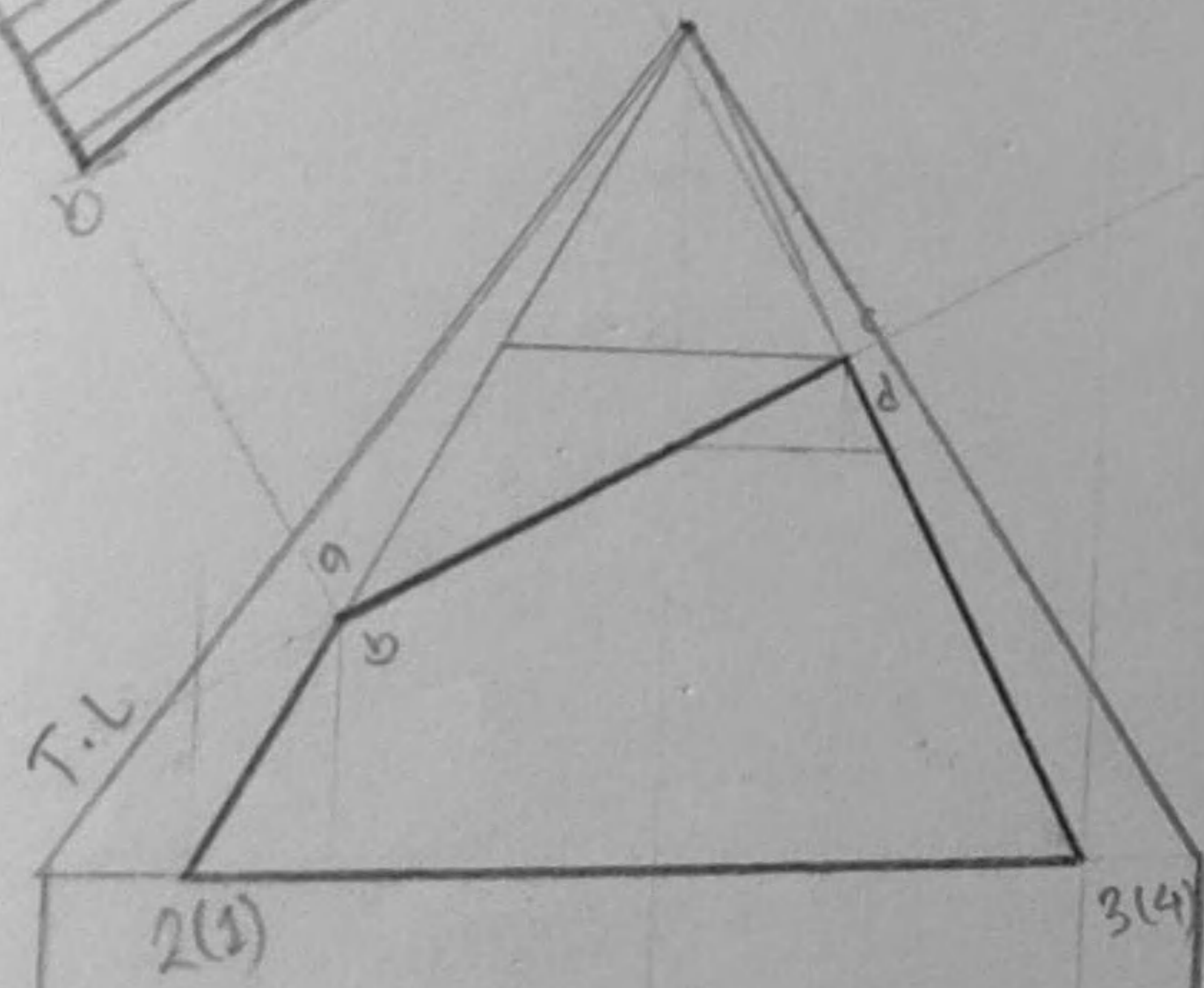
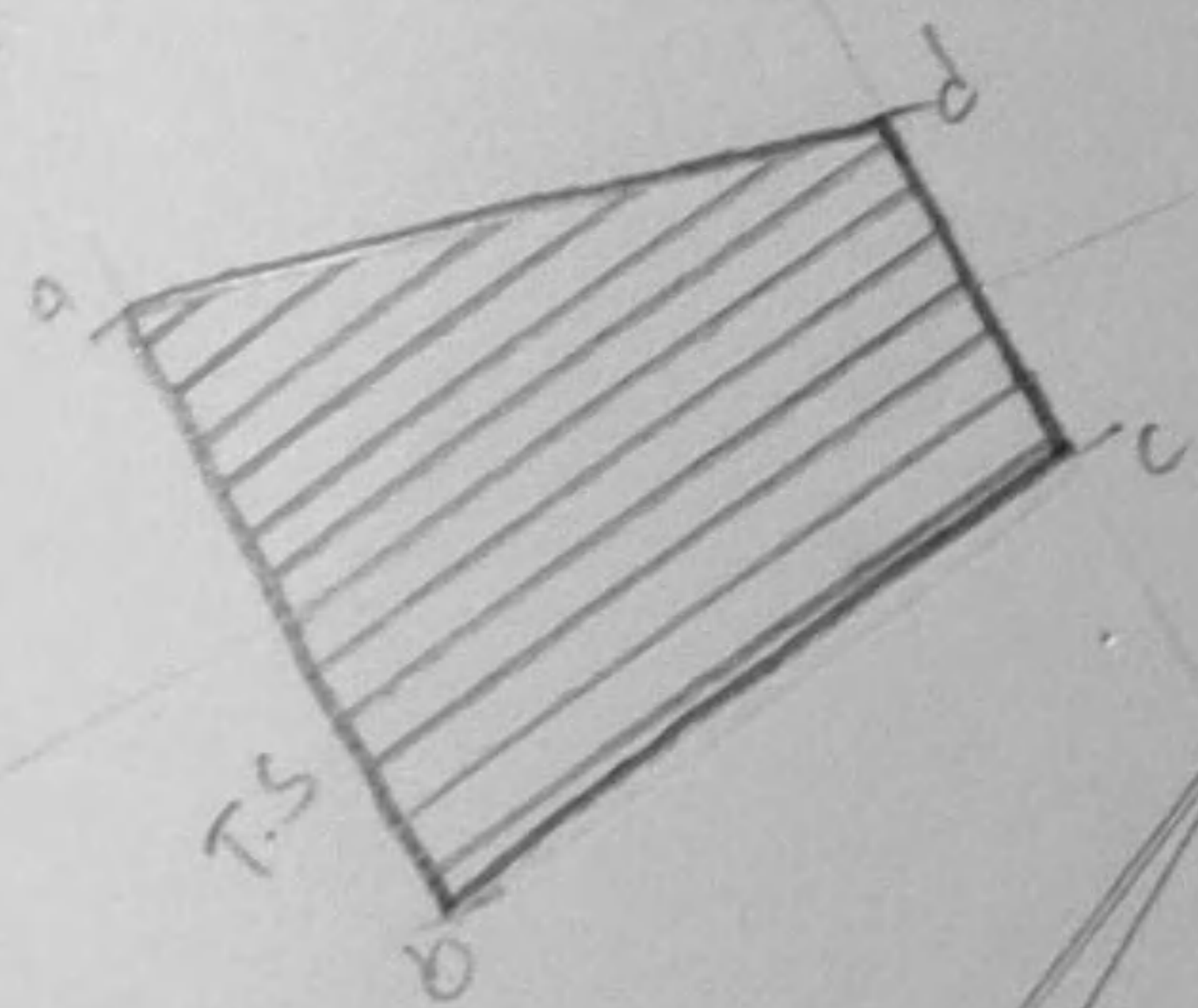
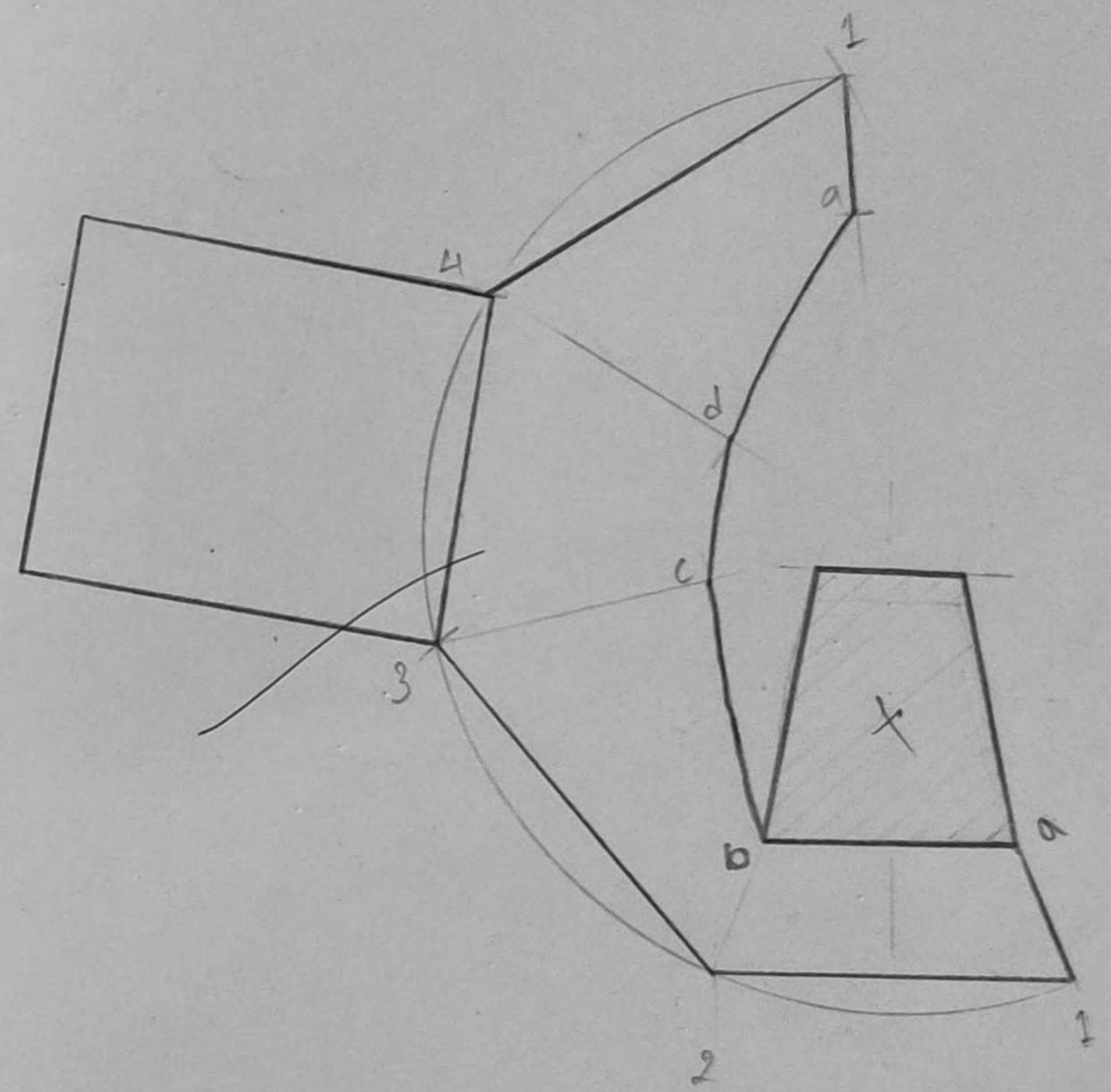
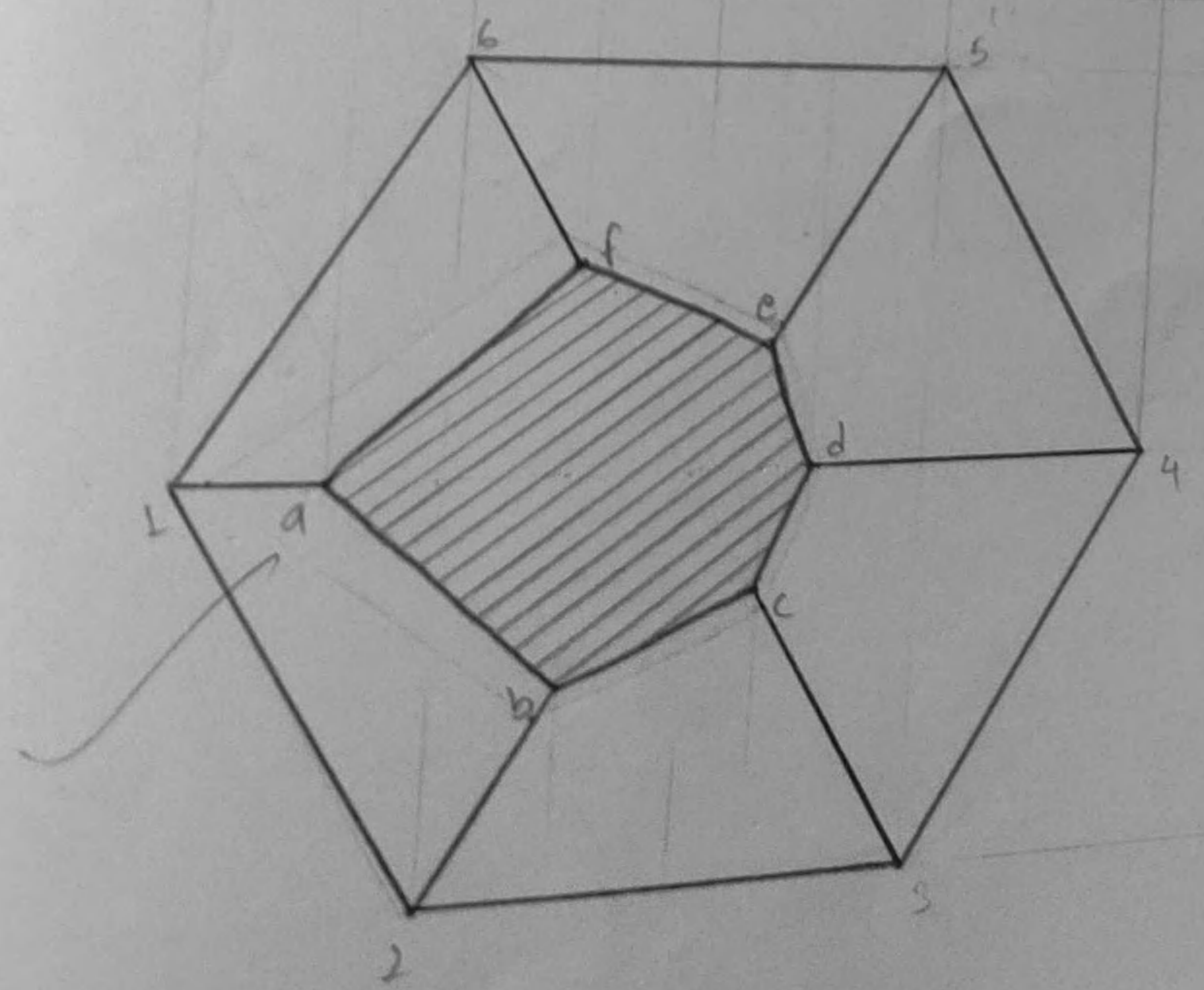
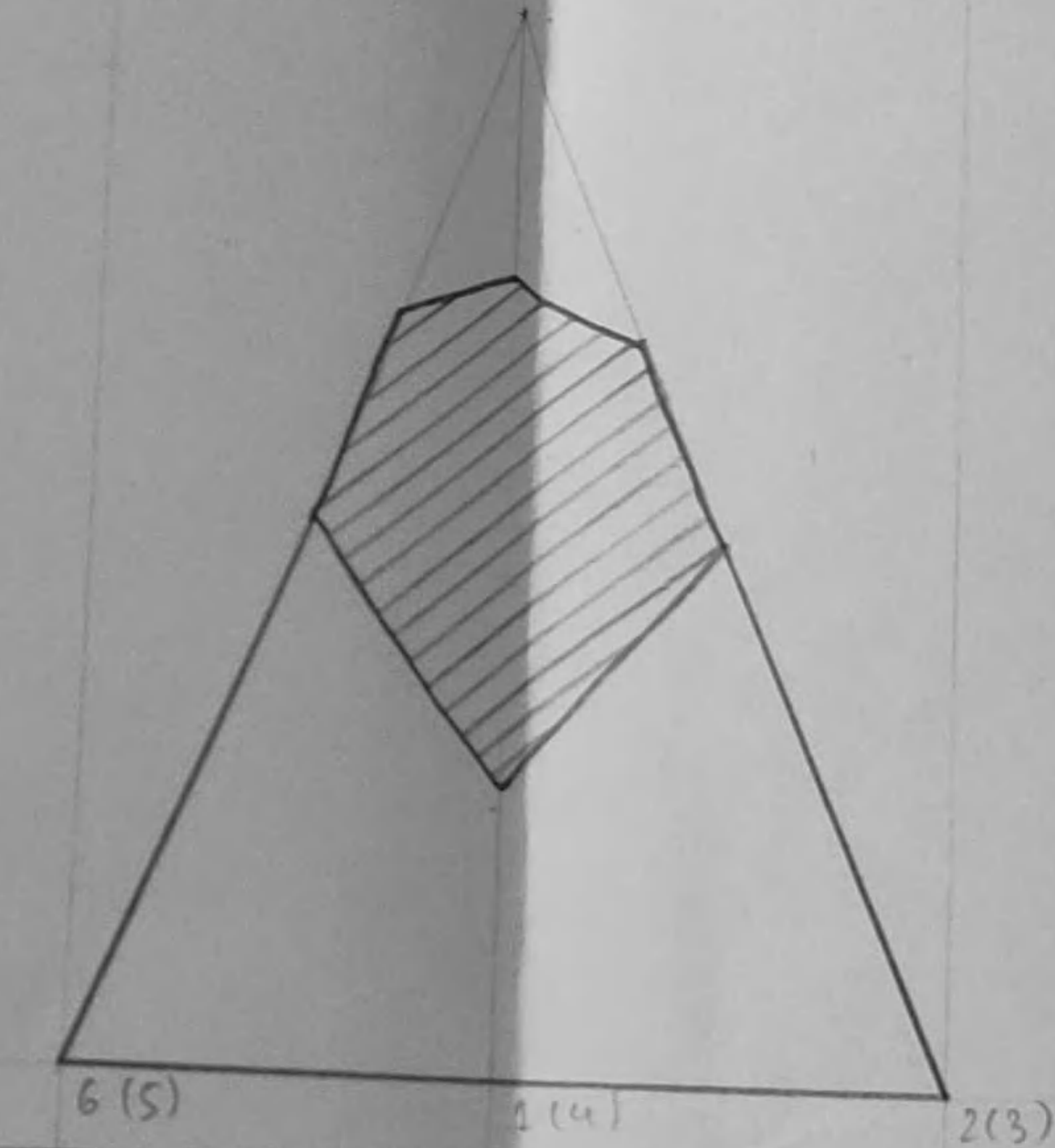
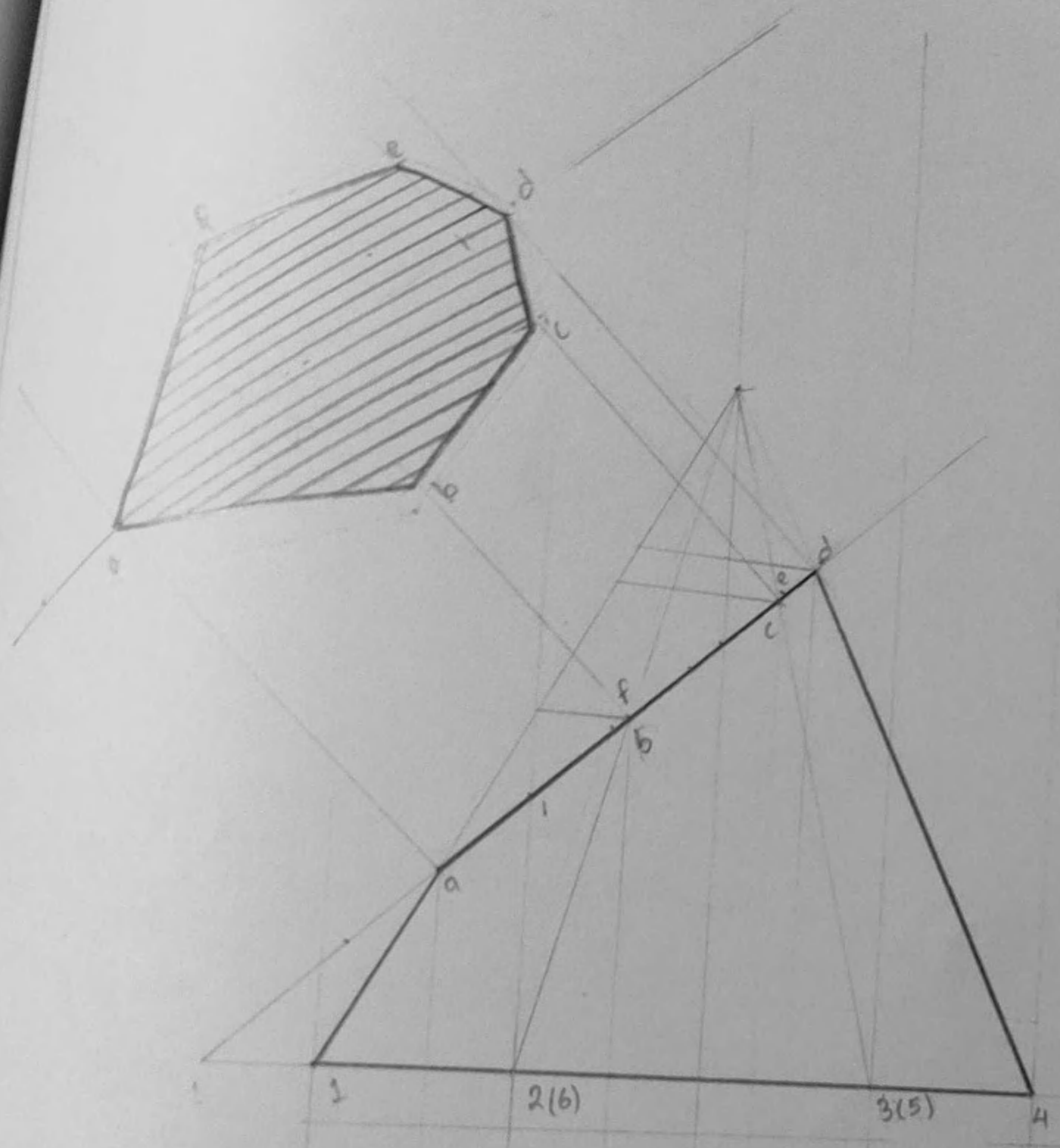
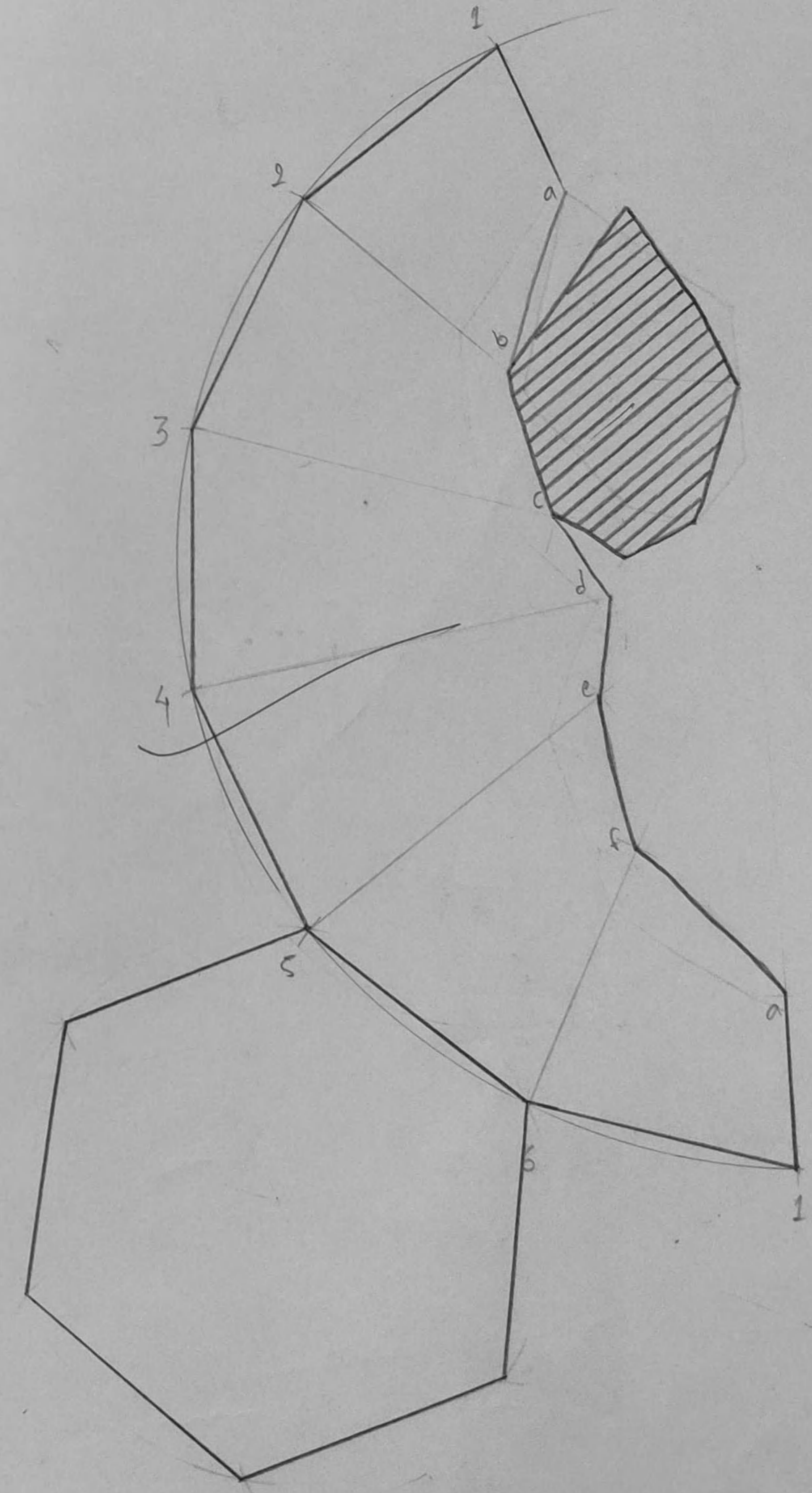

Fig 8.6





emtra question



20x

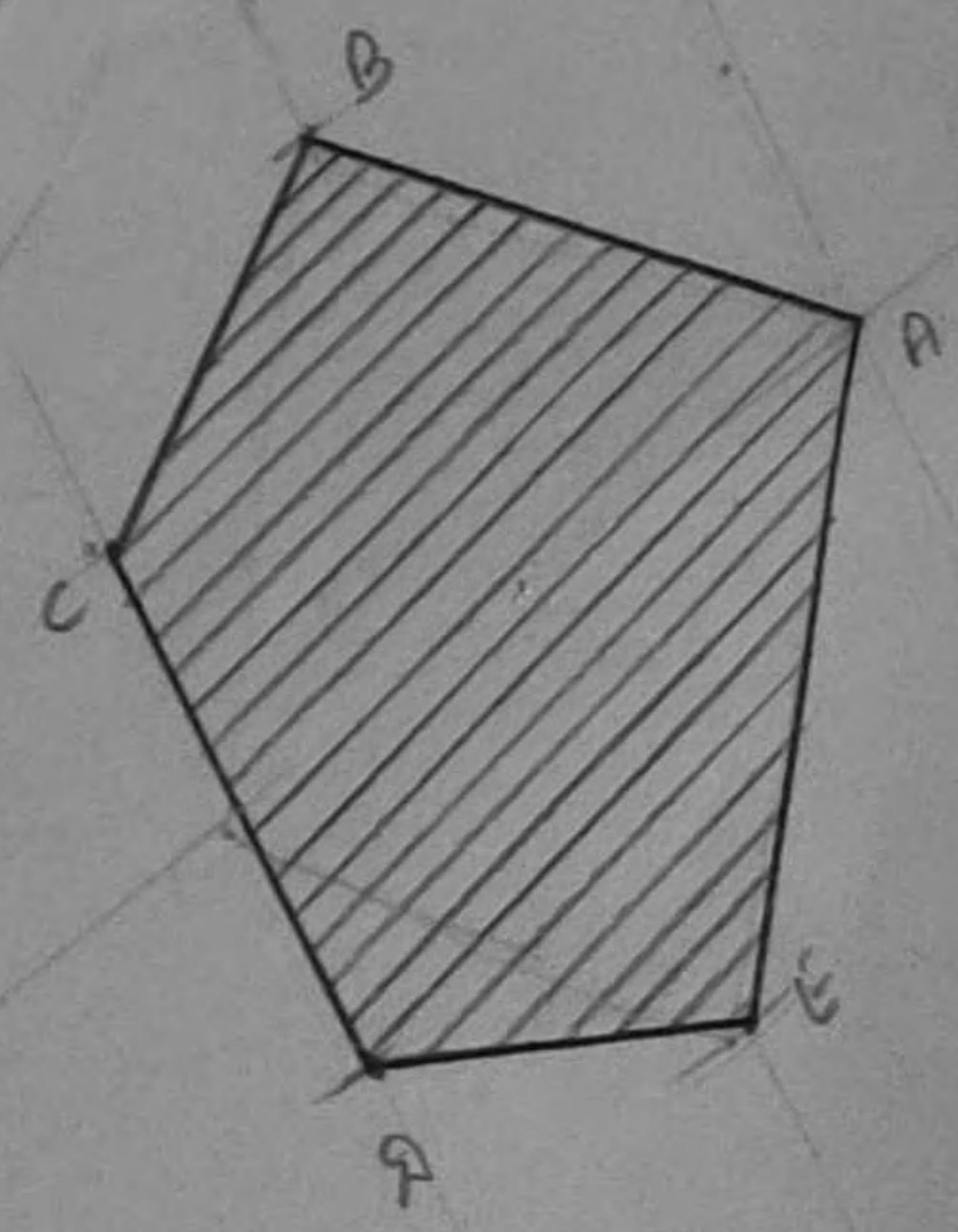
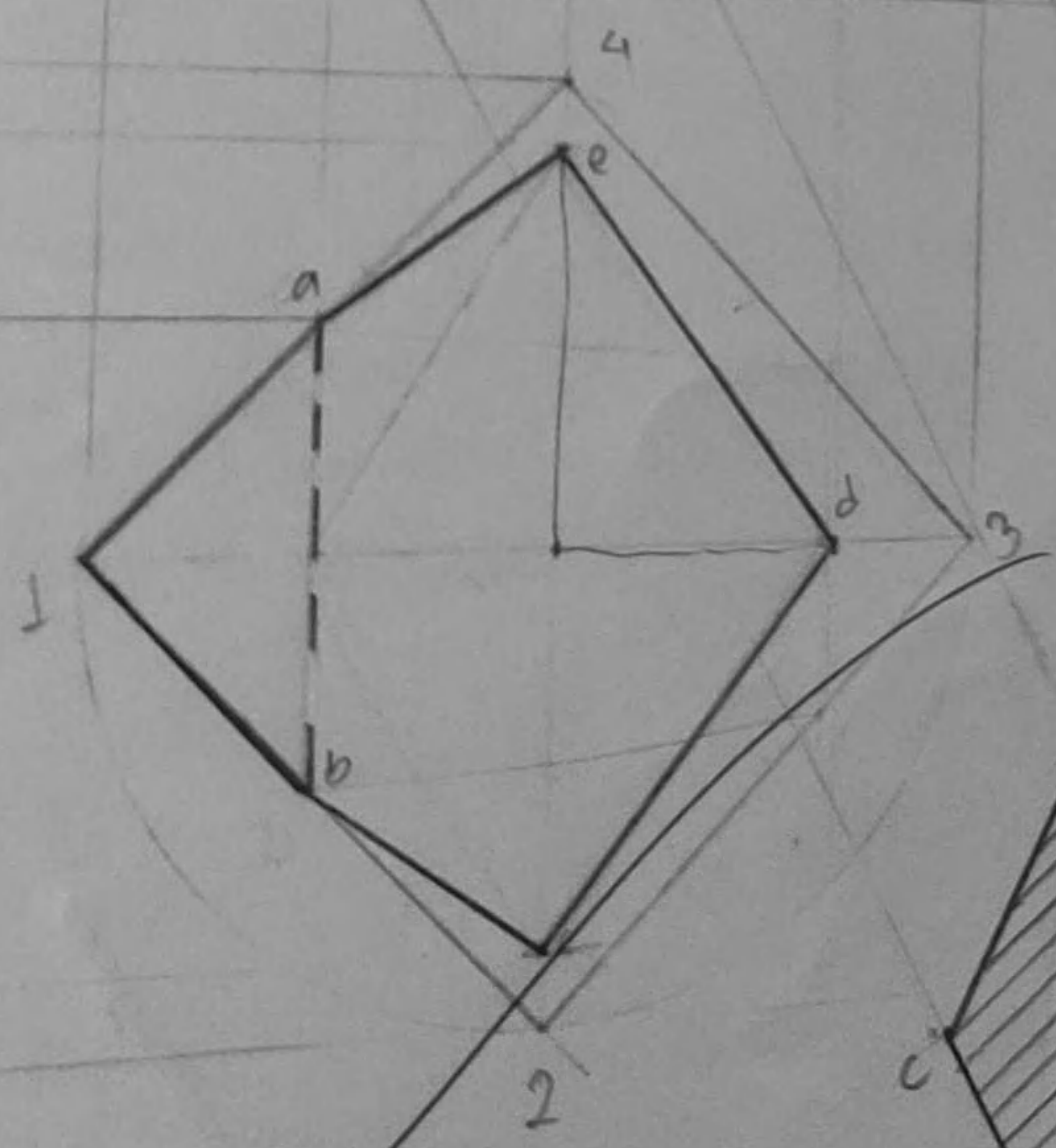
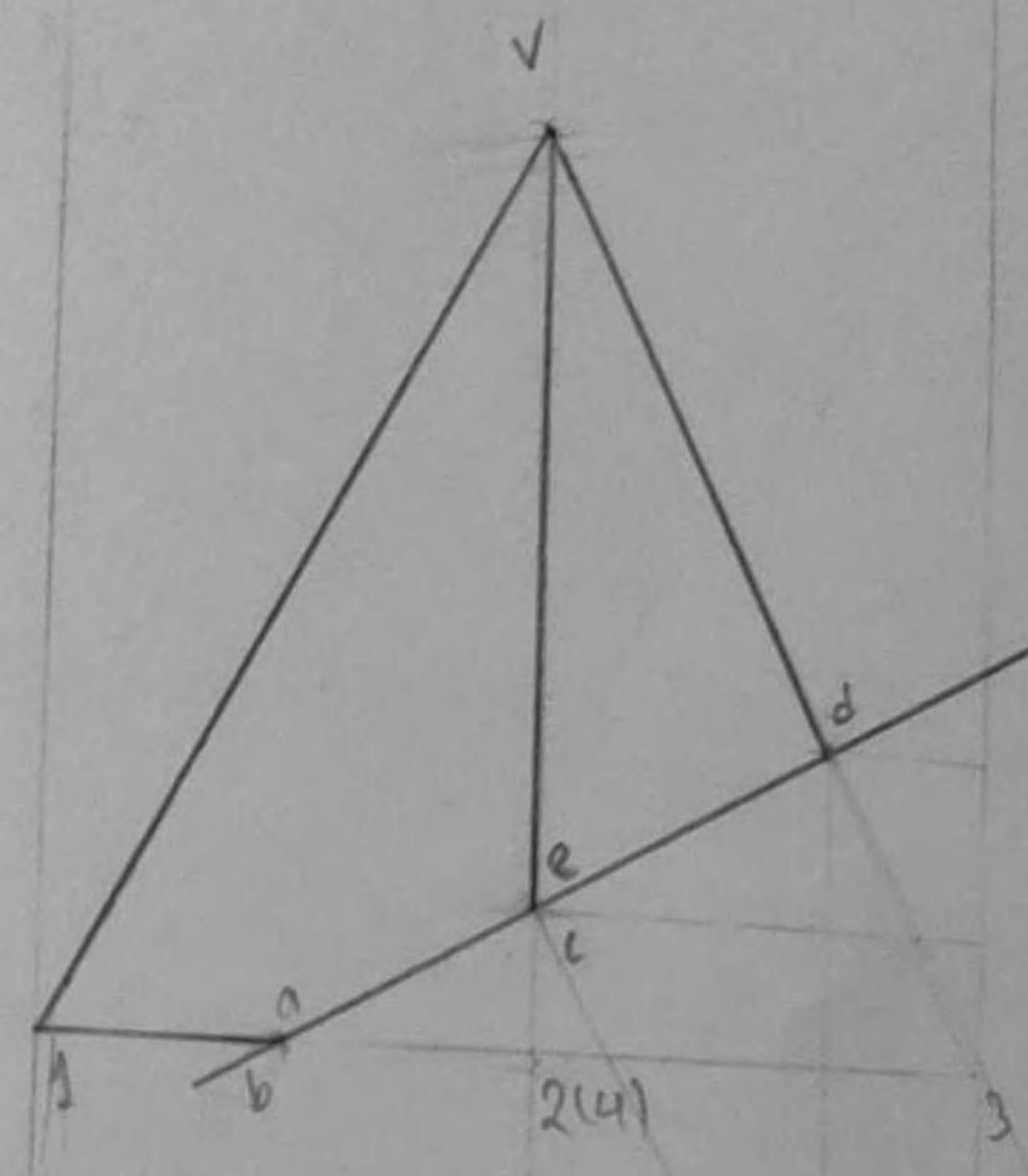
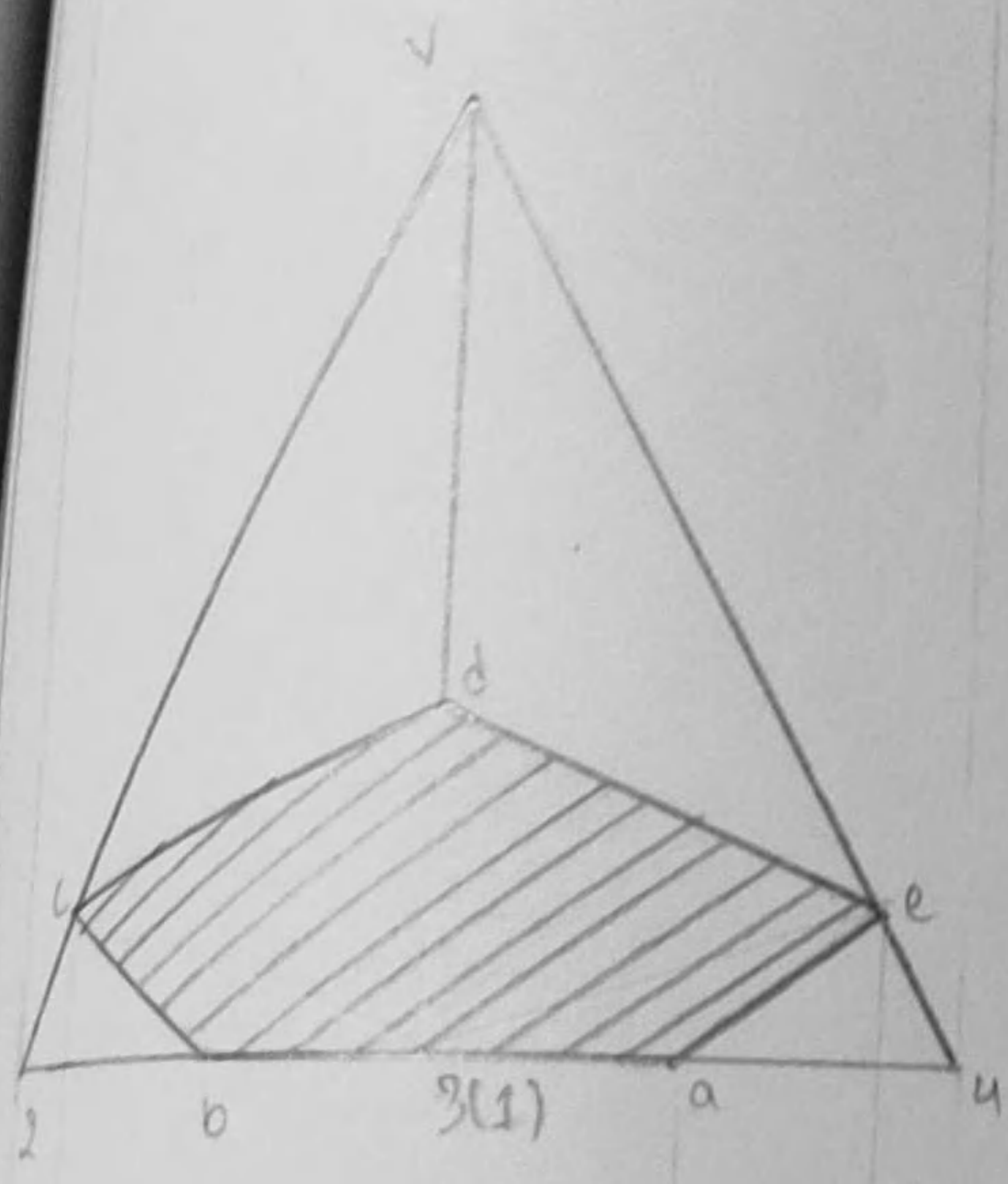

cor

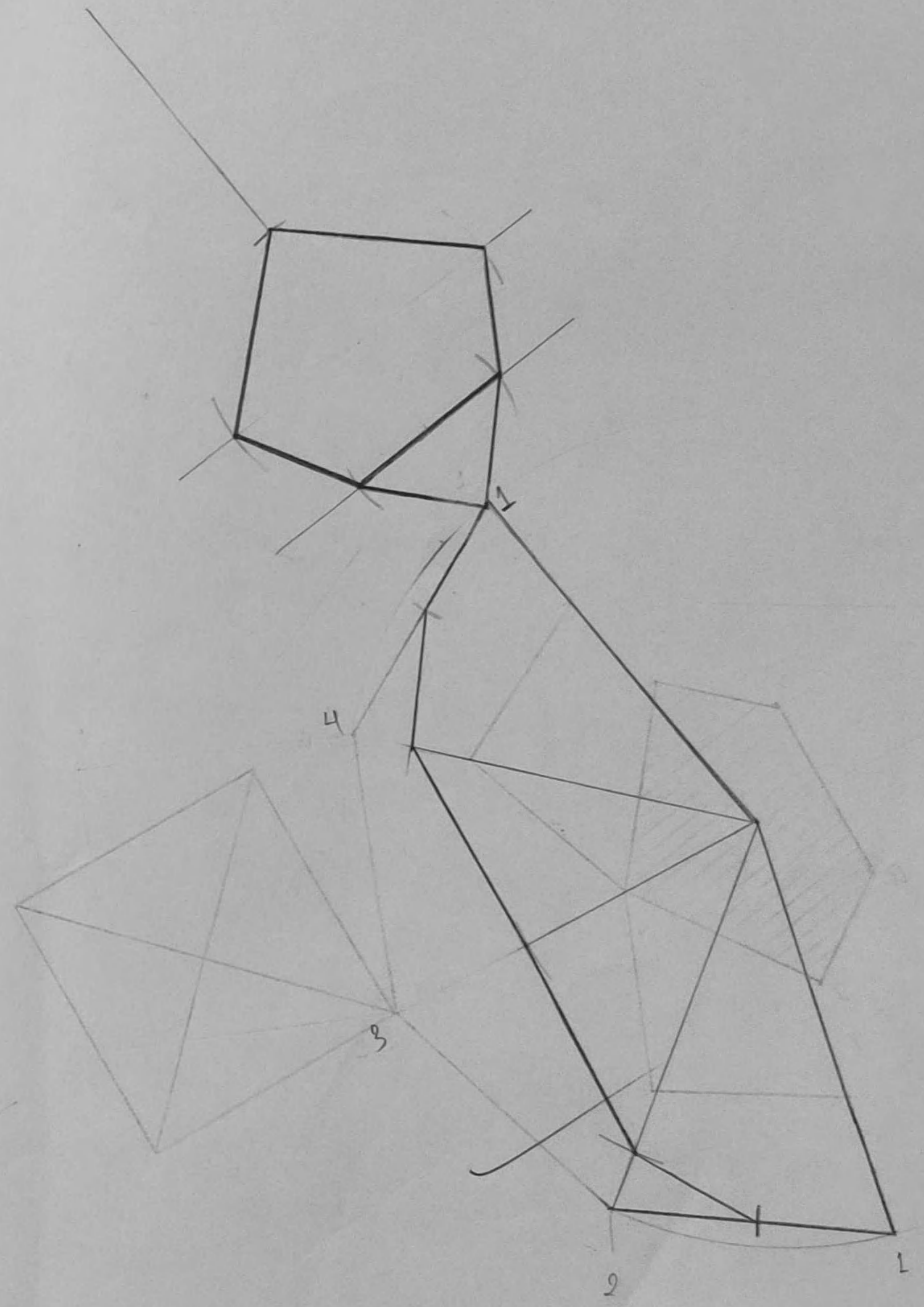

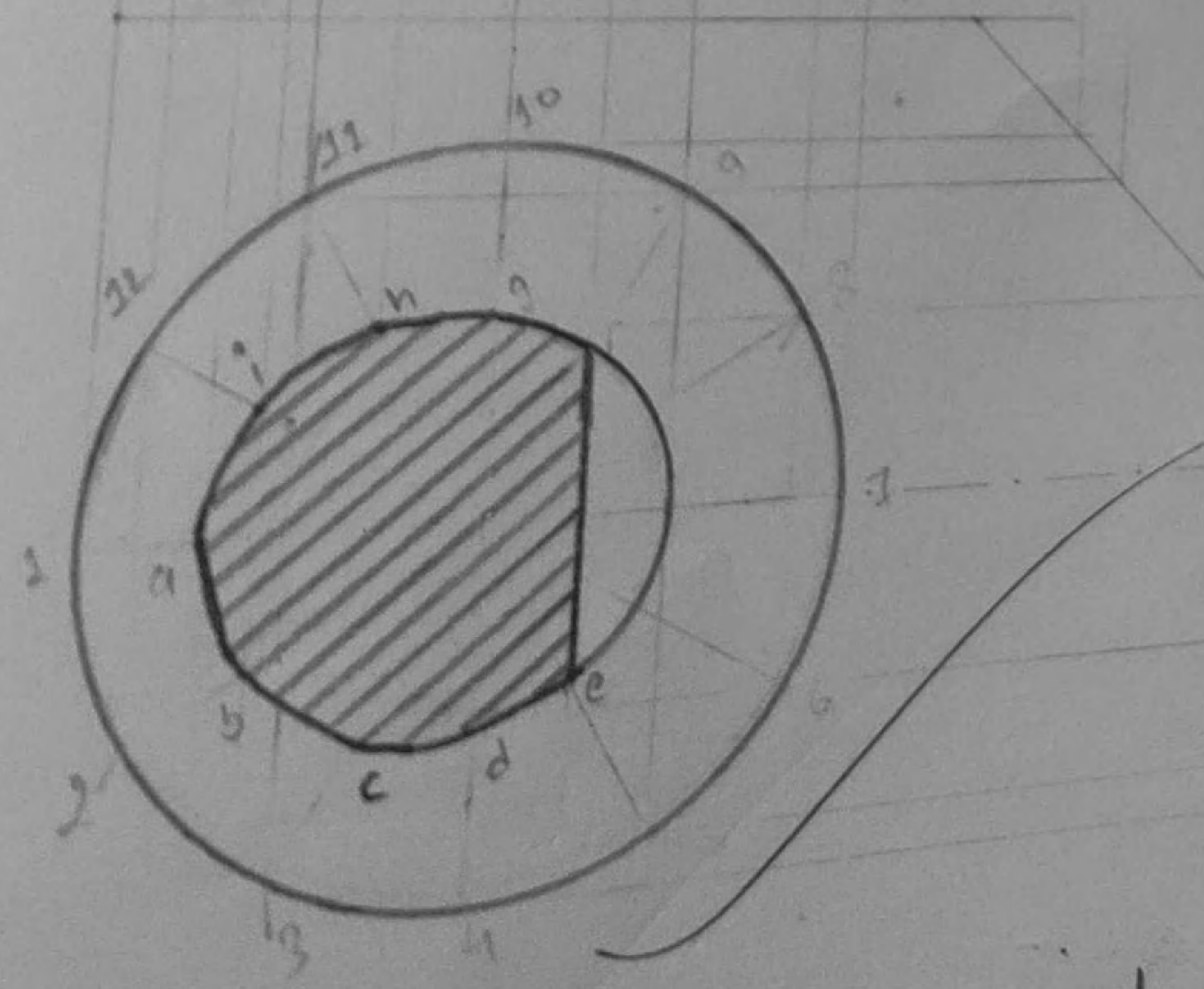
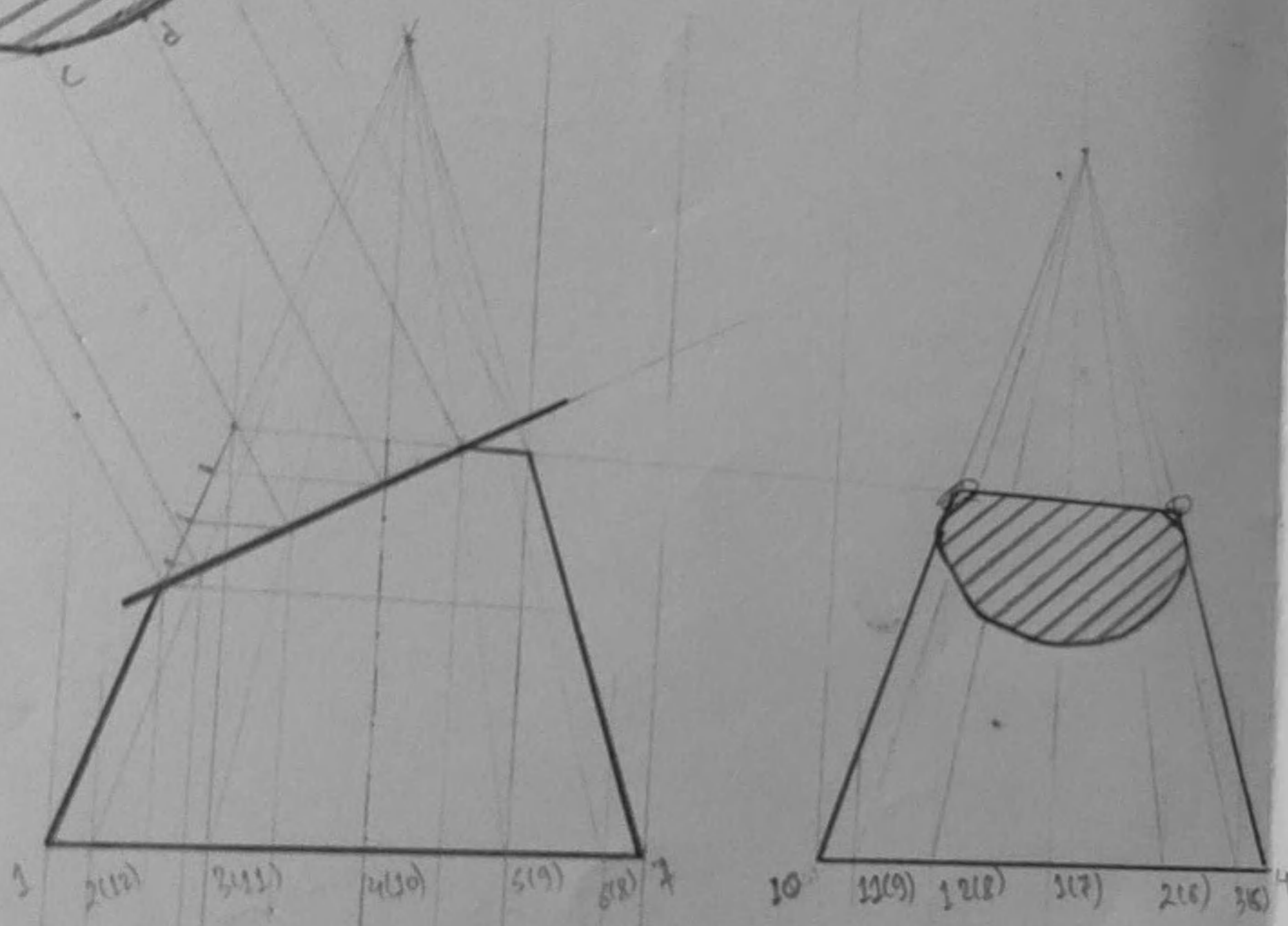
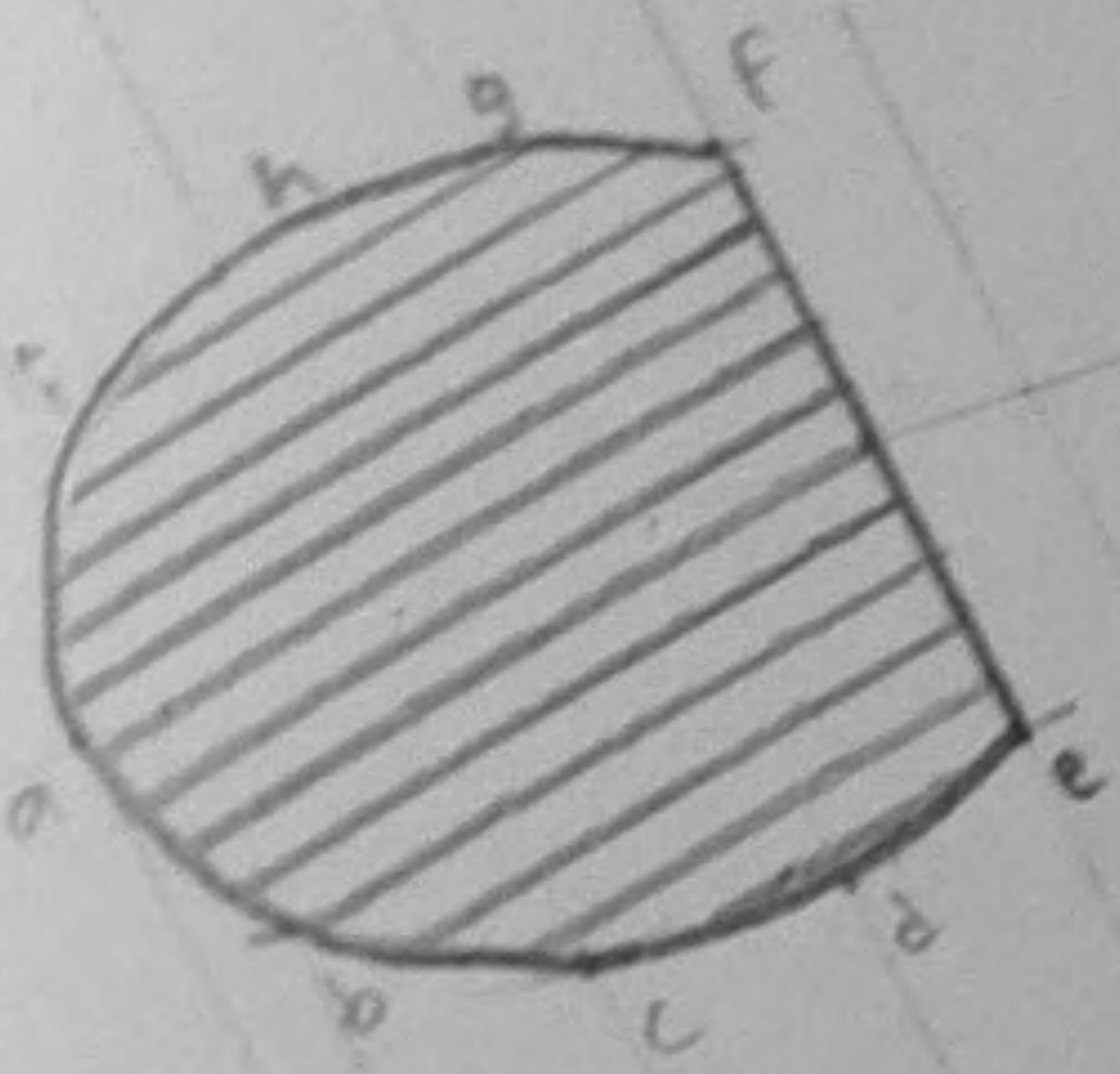

fig 9-5

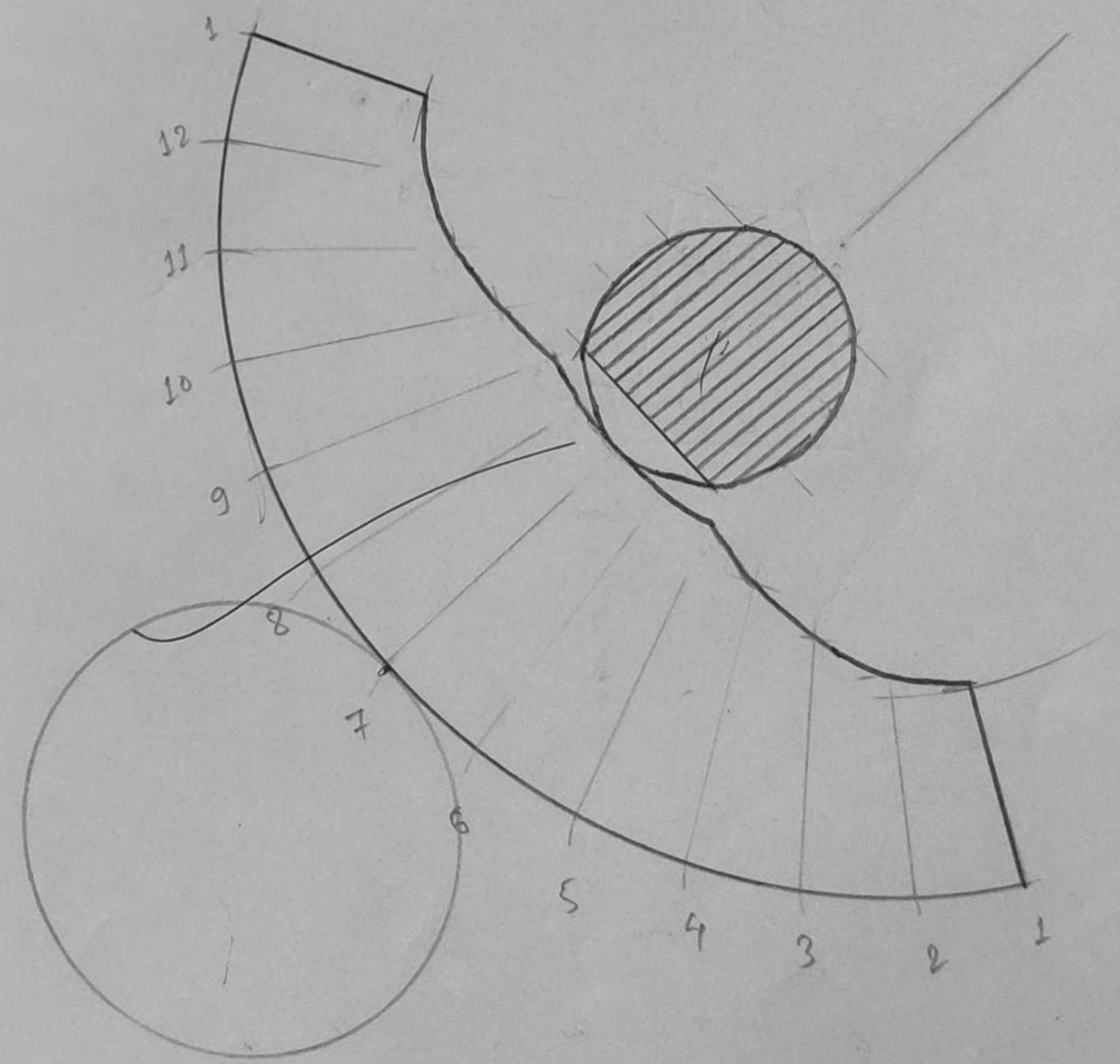

fig 9-5

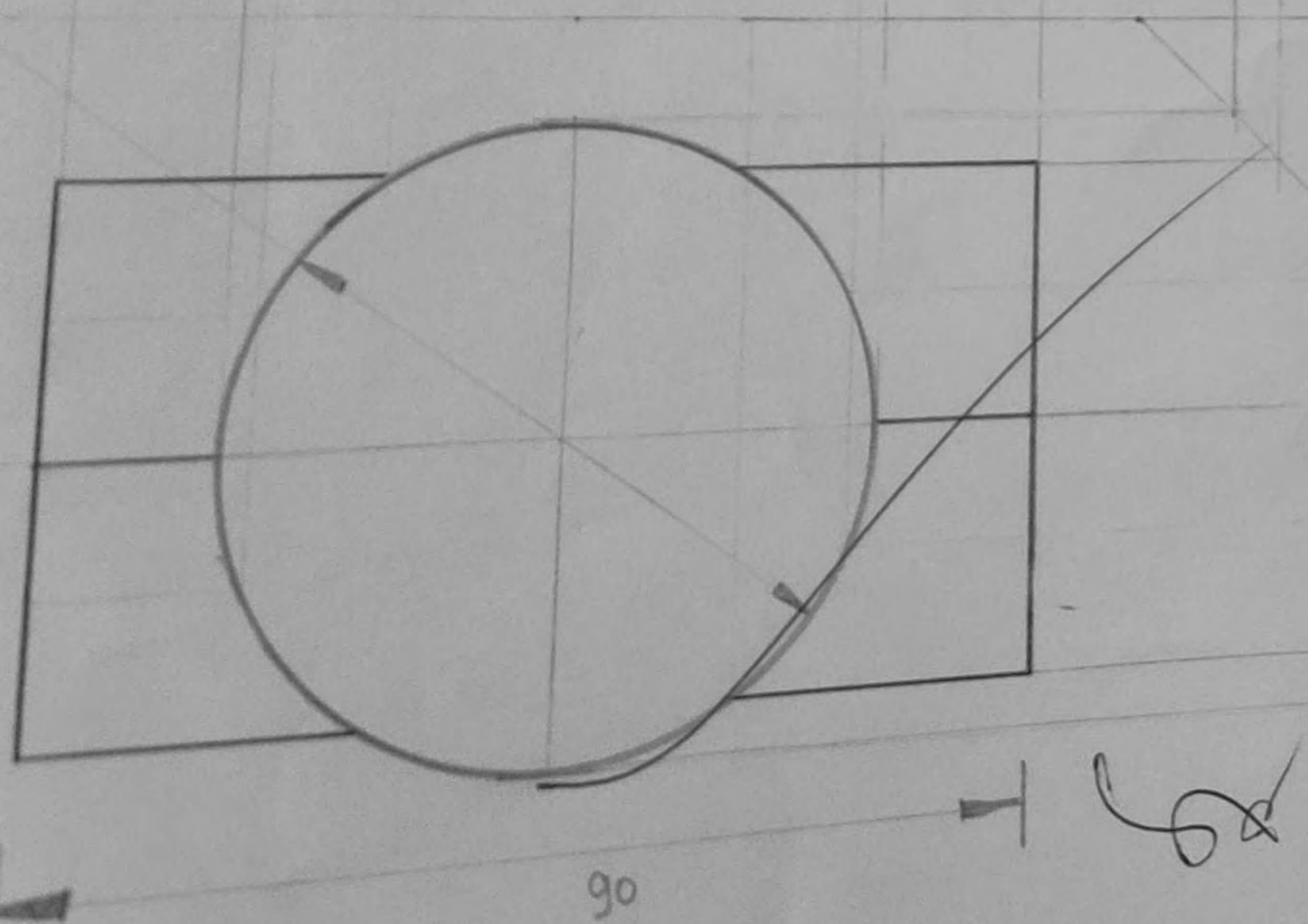
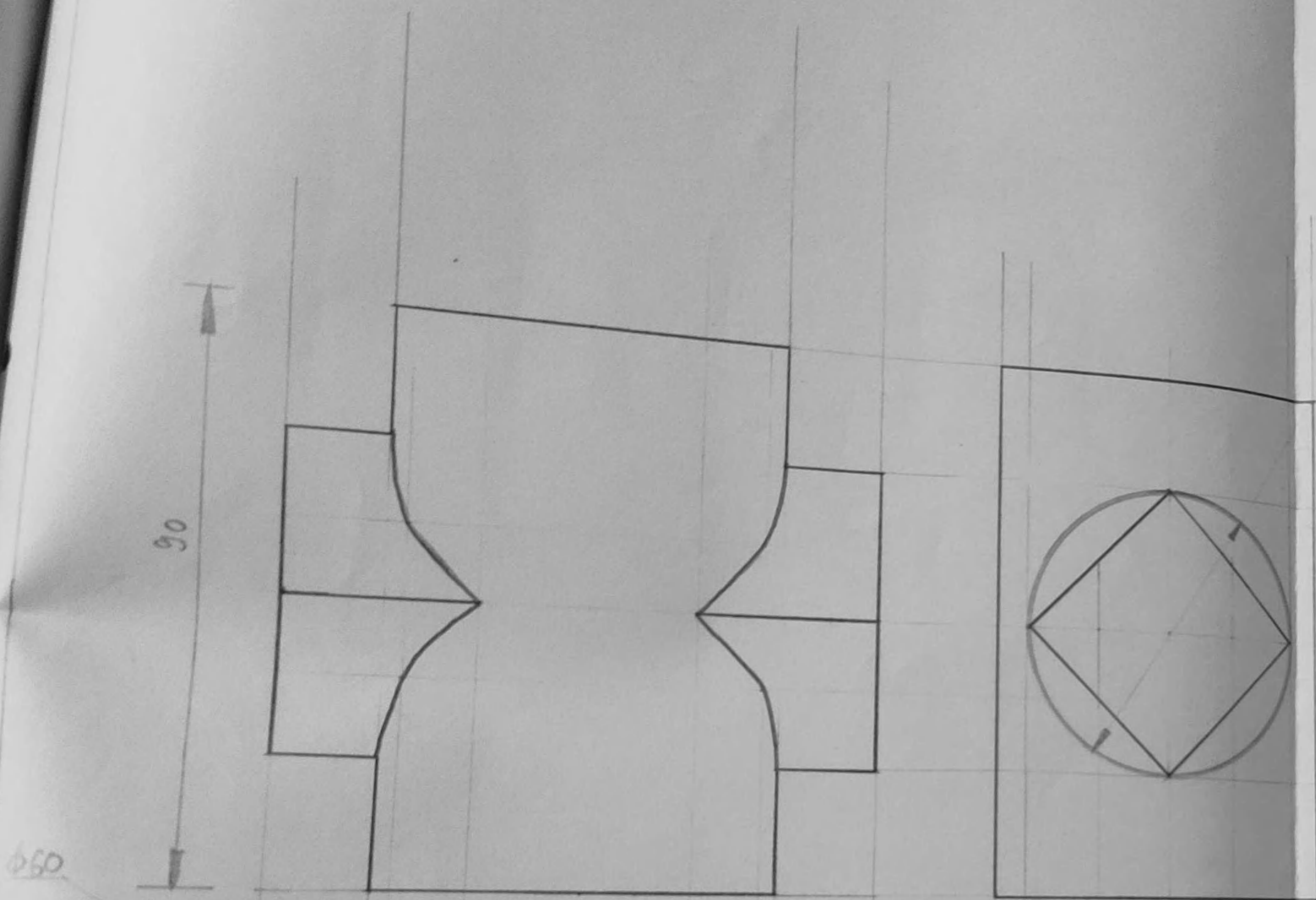

fig 10.1

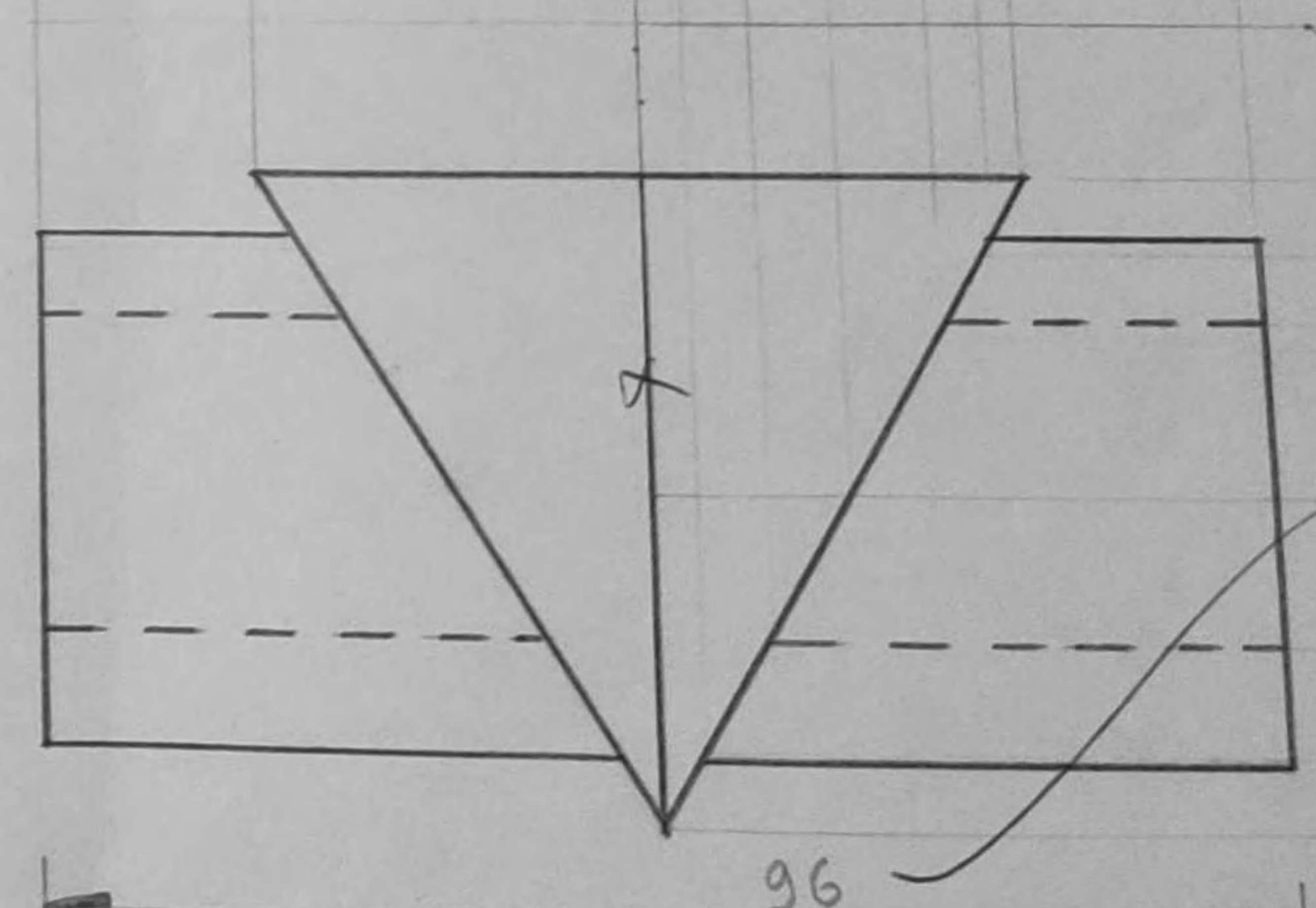
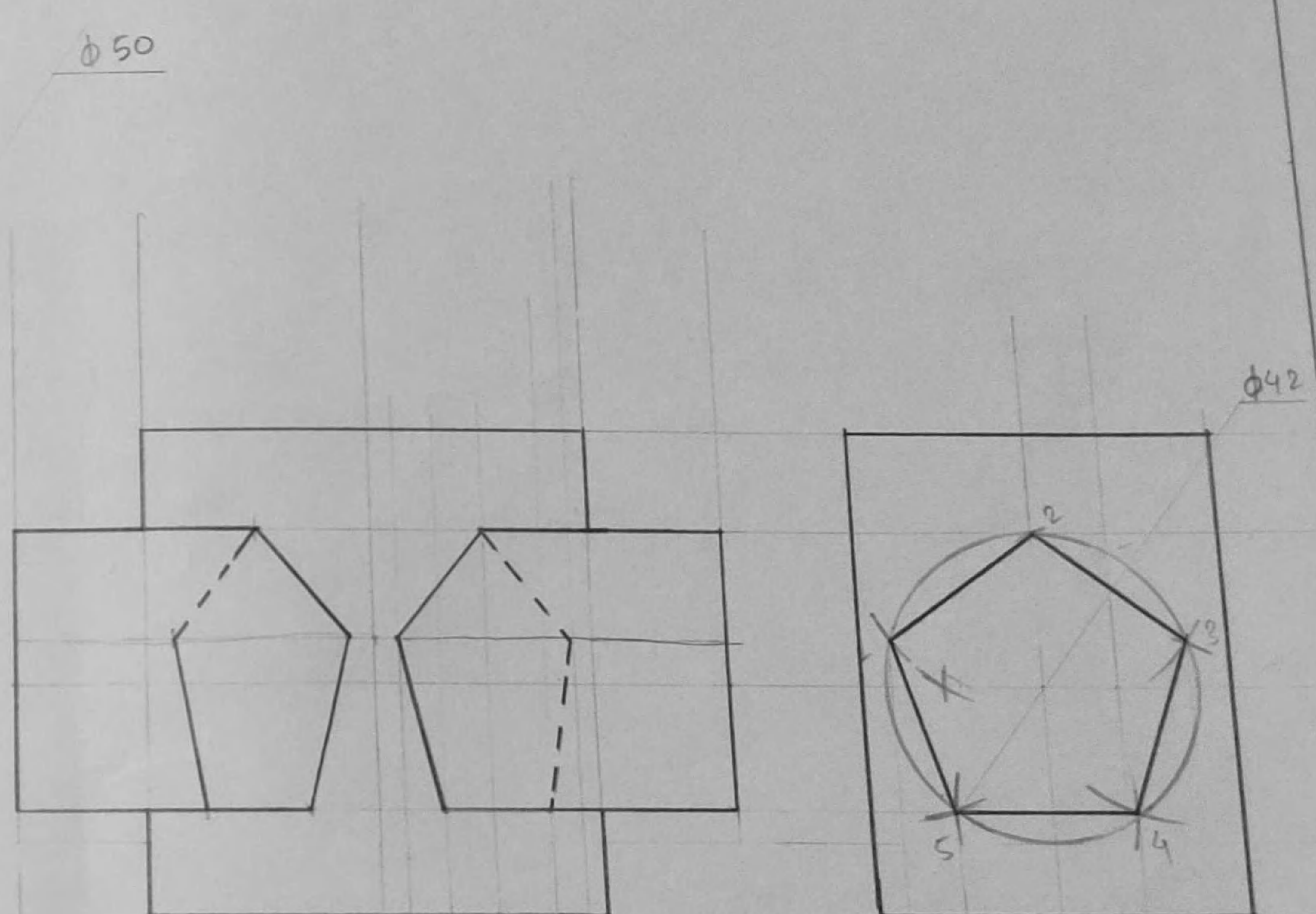

fig 10.3

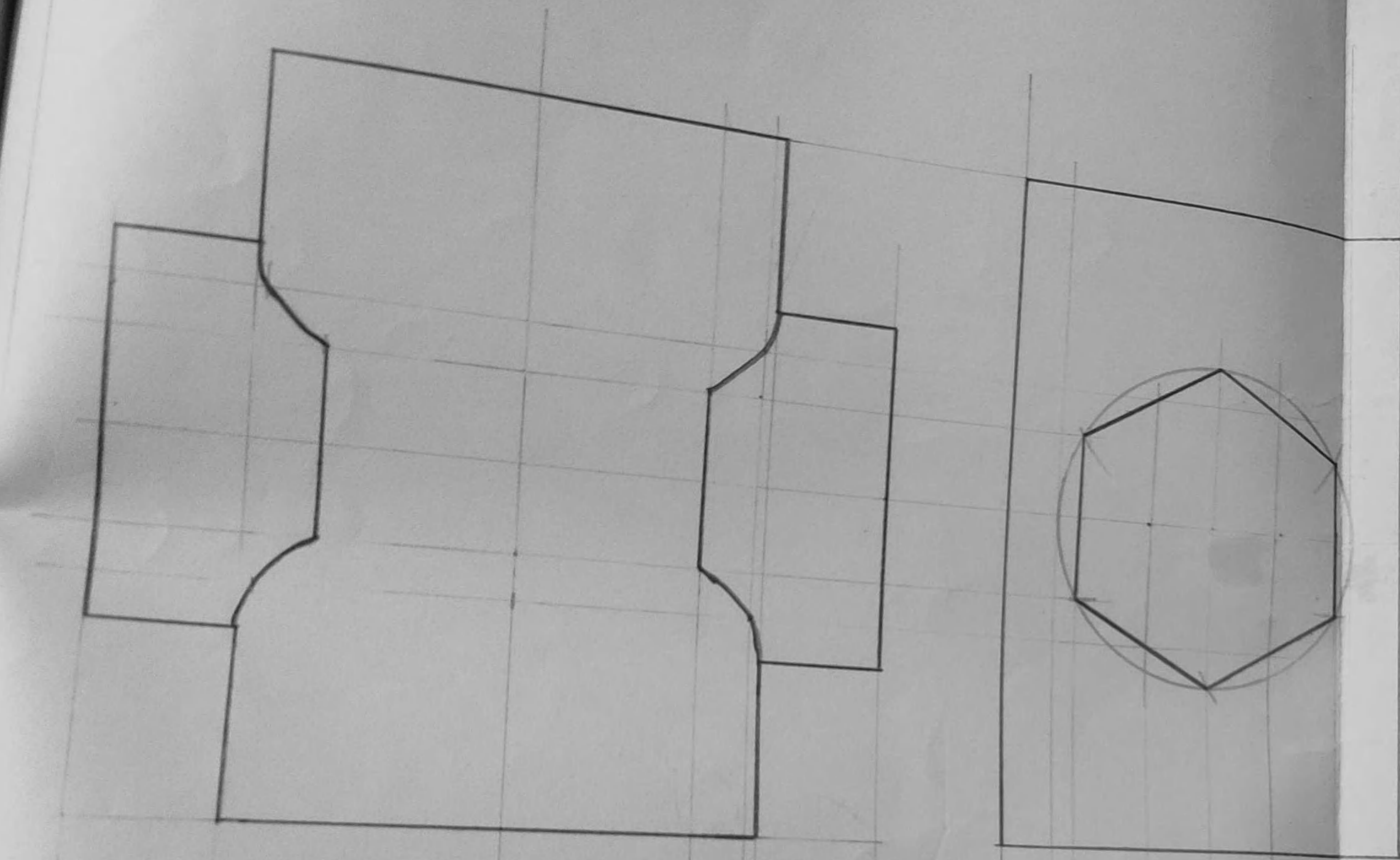

Fig 10.2

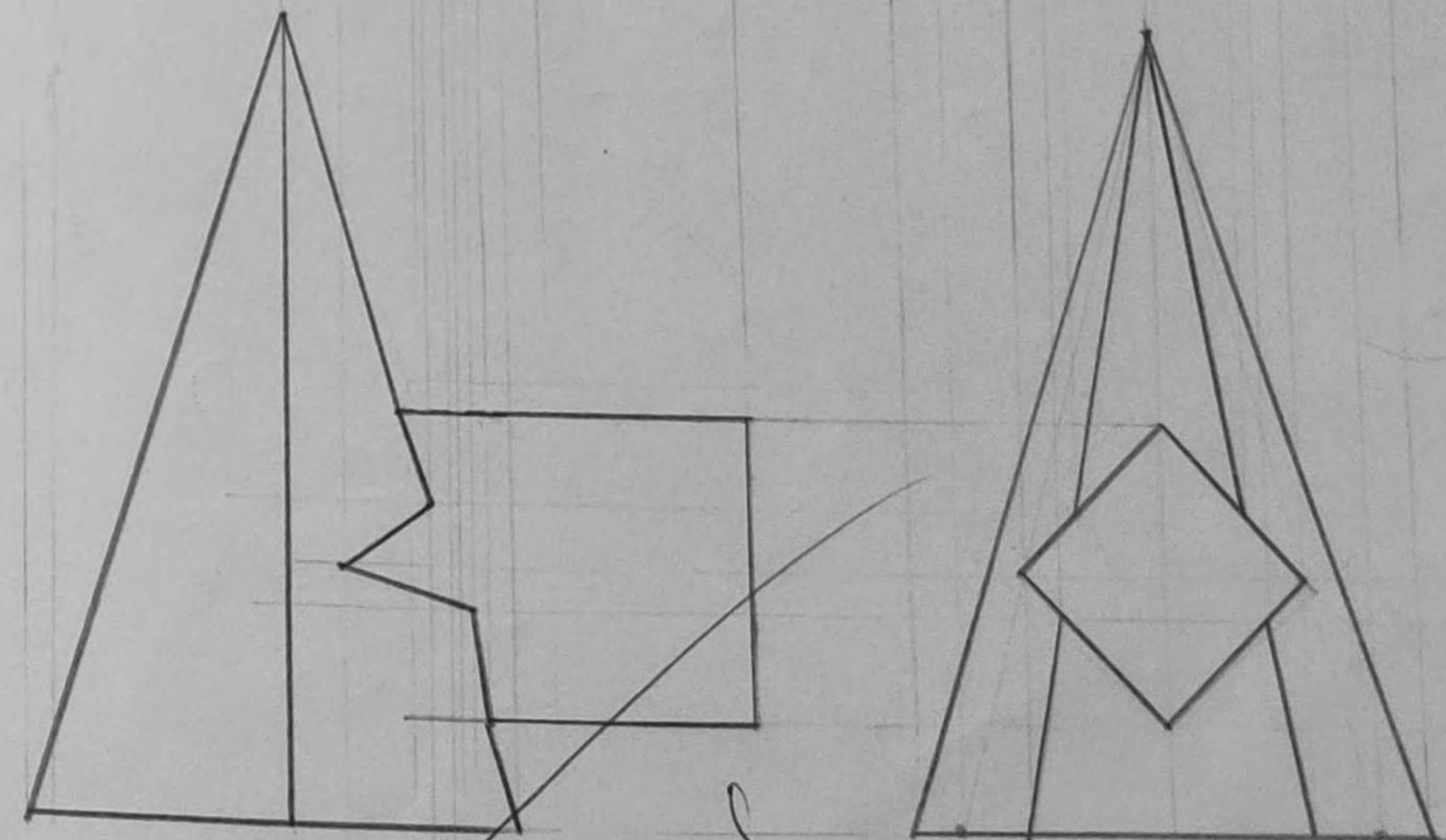
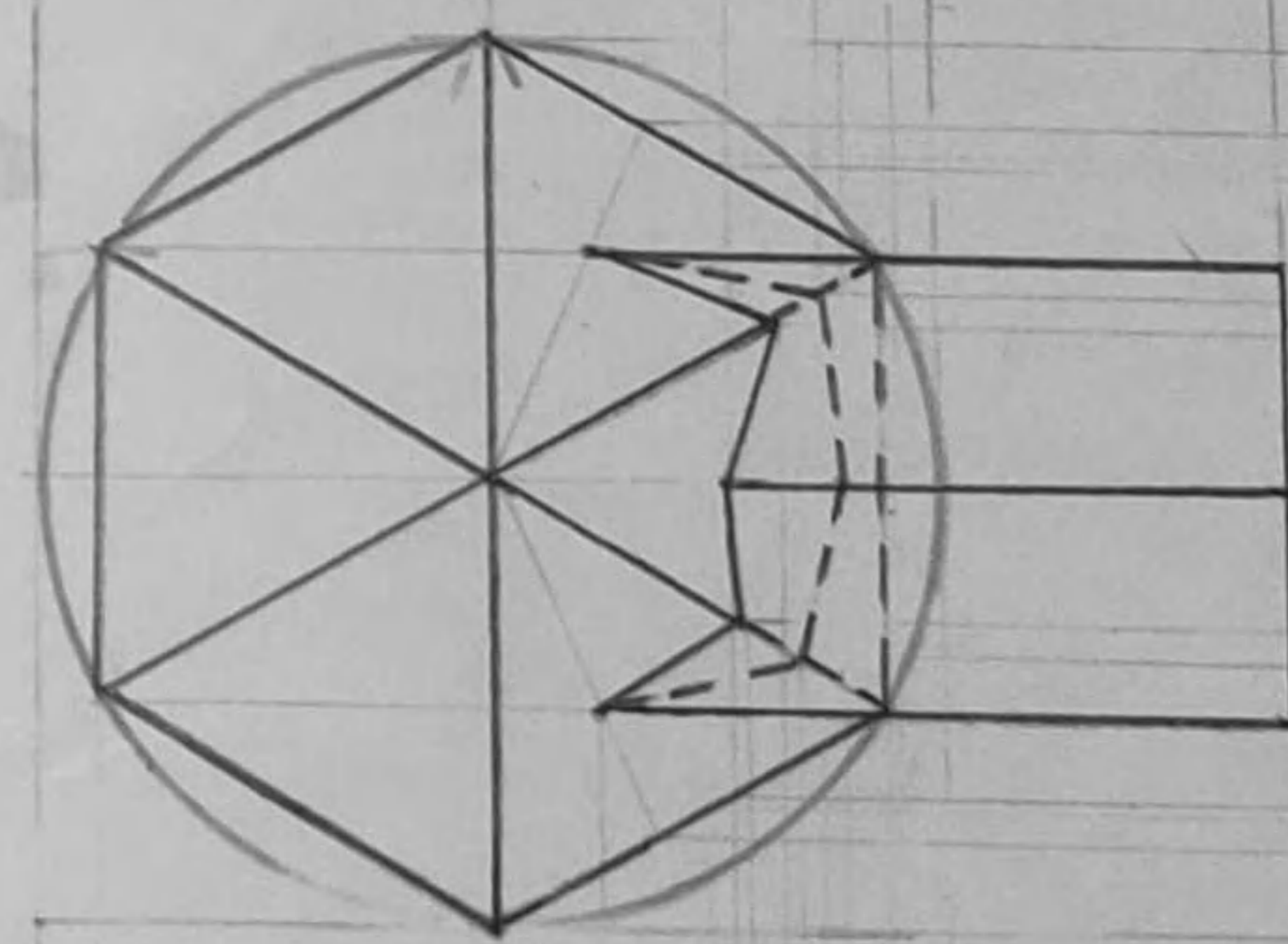
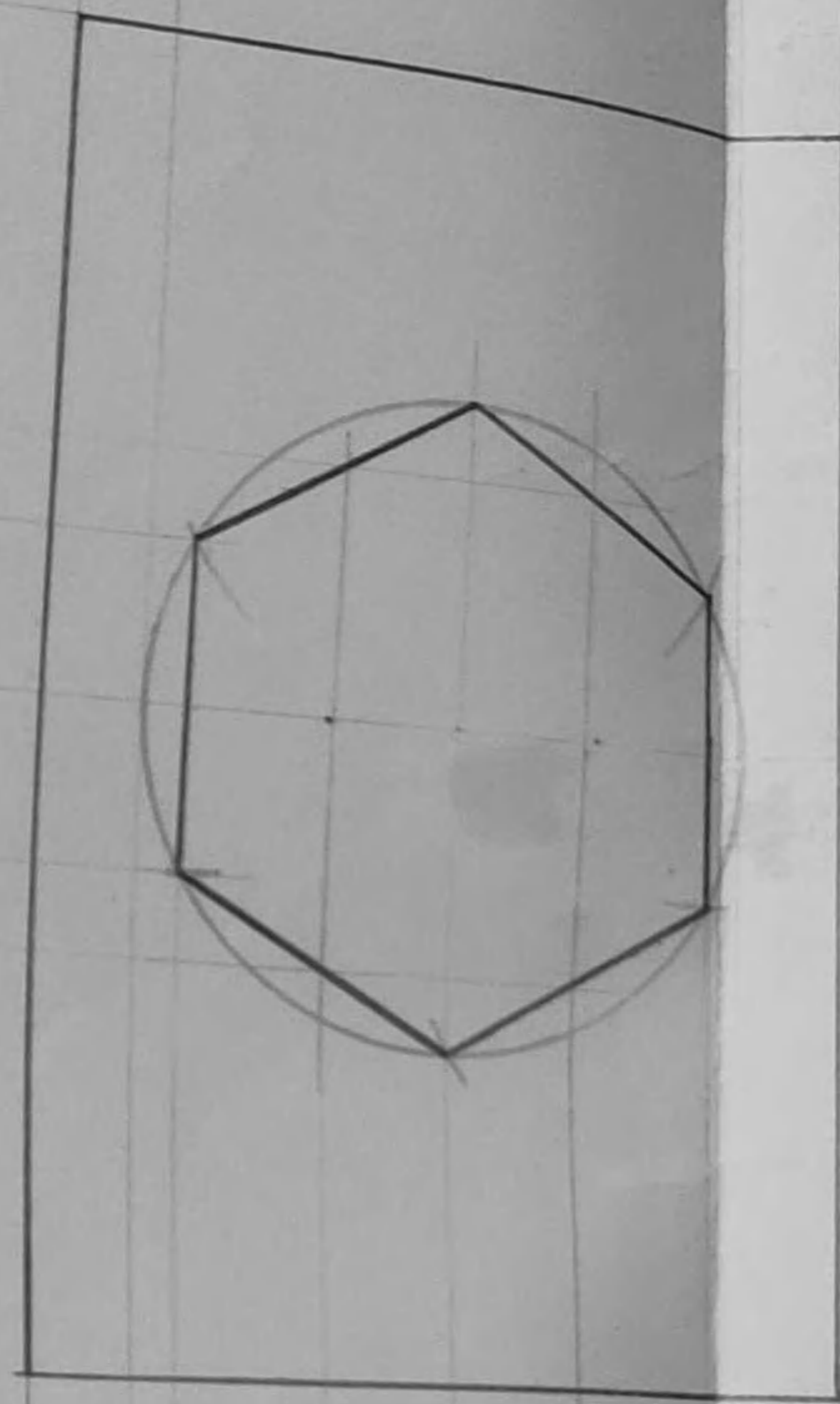

Fig 10.7

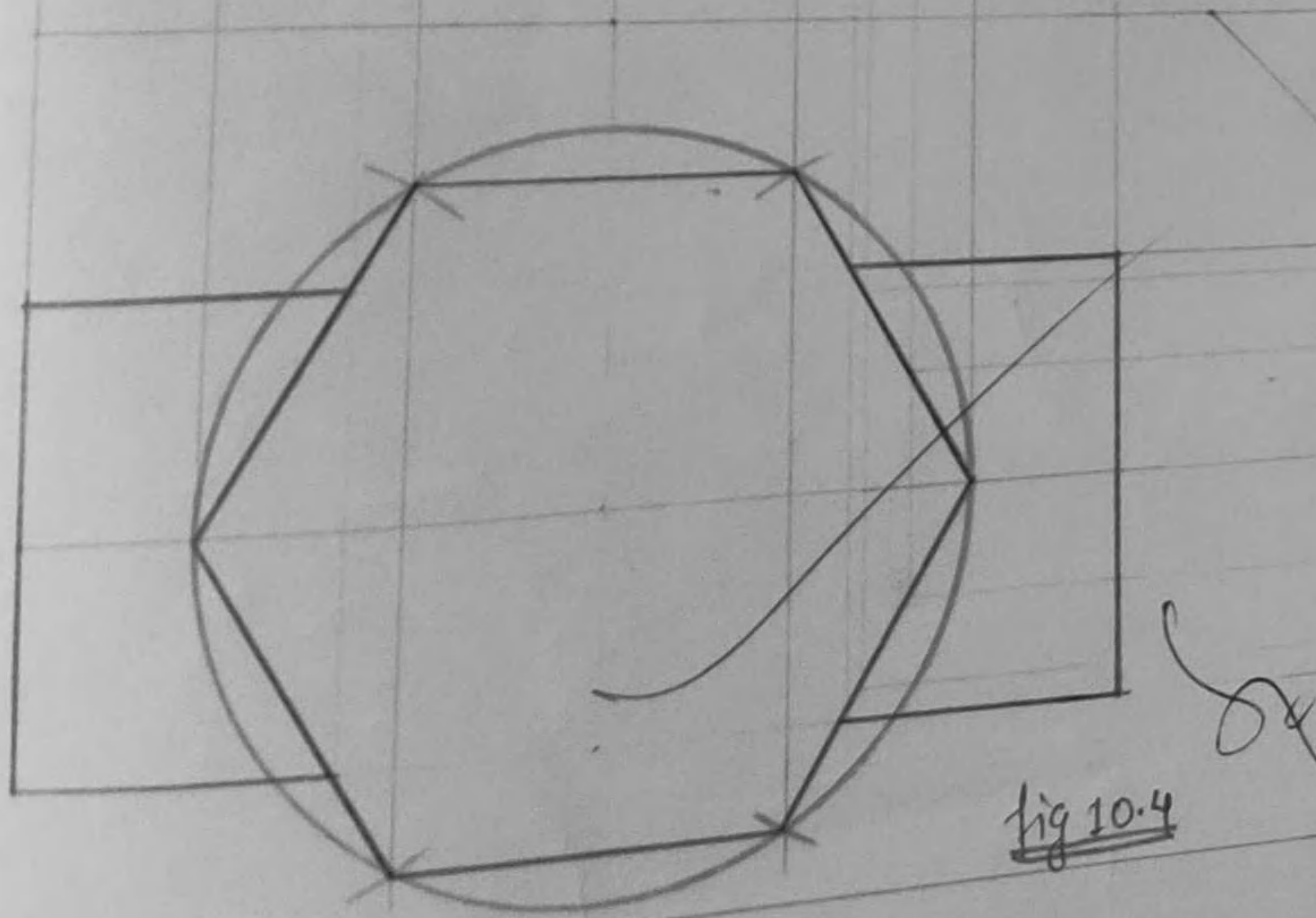
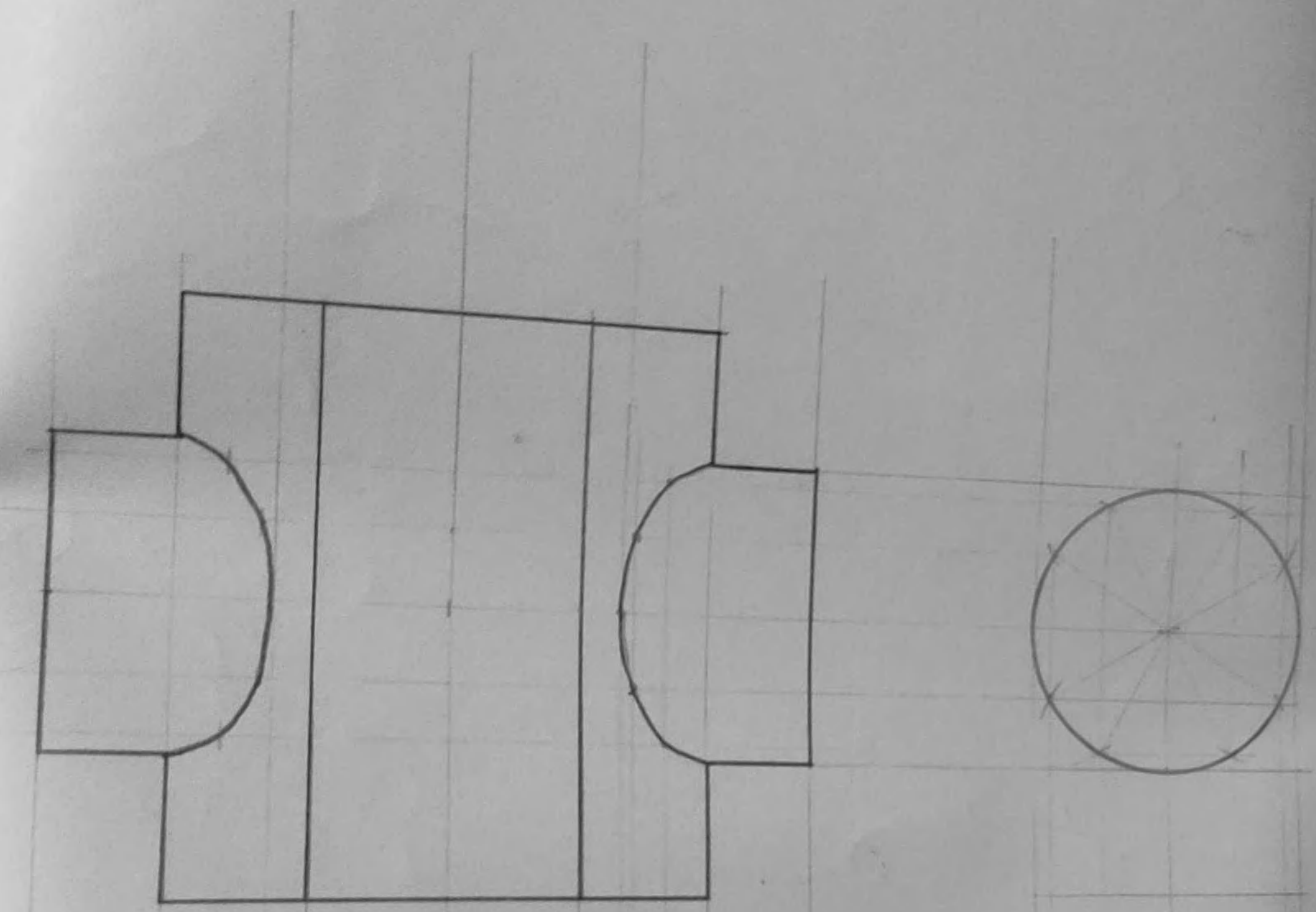

fig 10.4

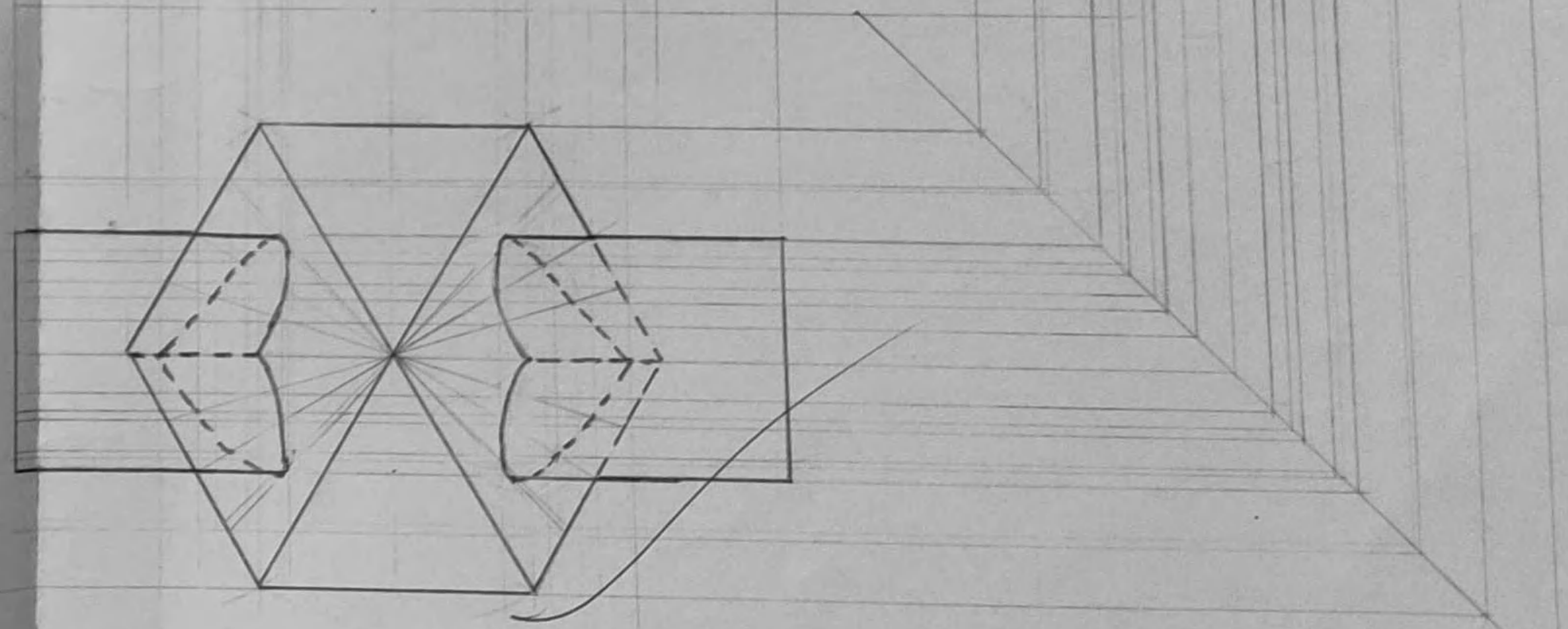
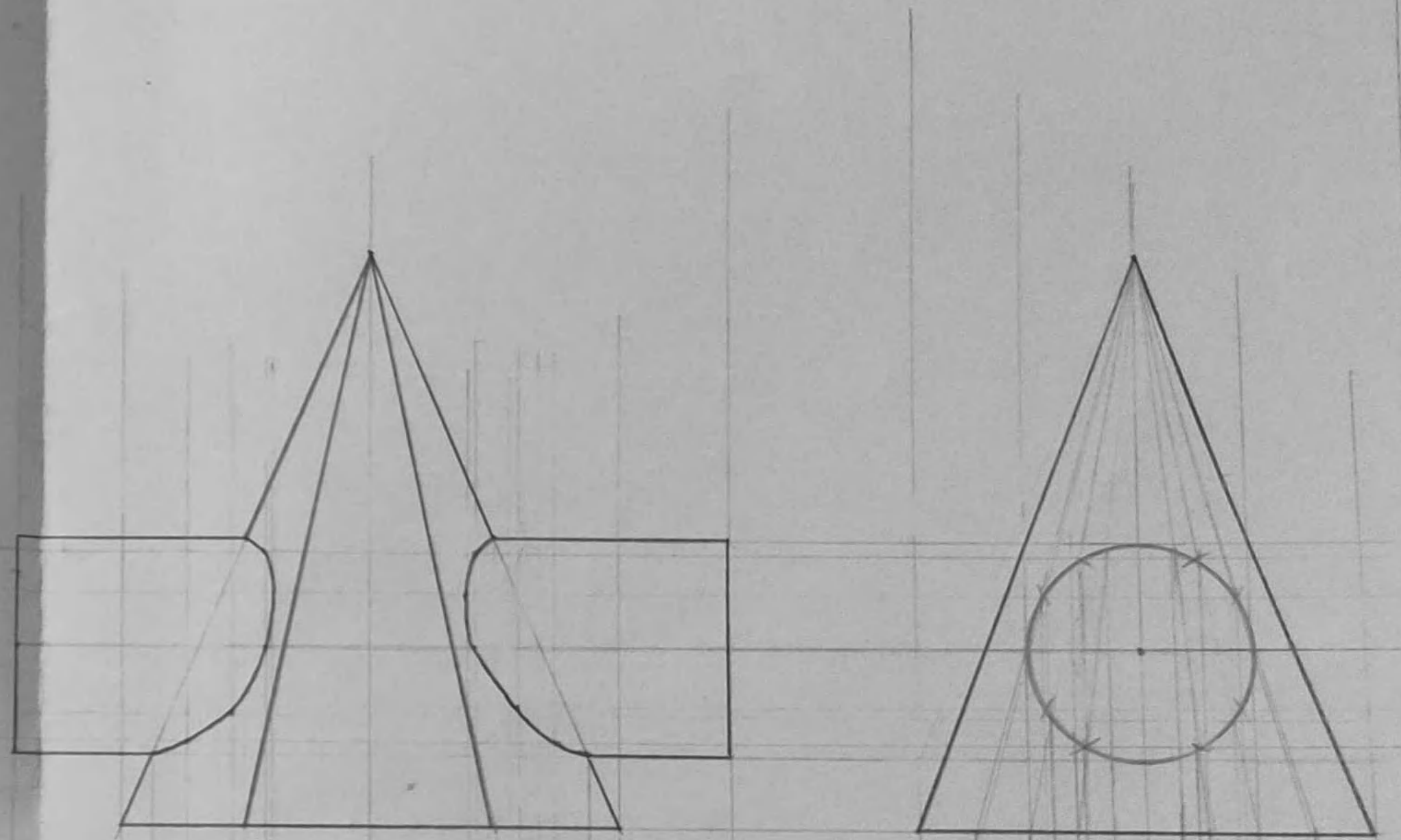

fig 10.8

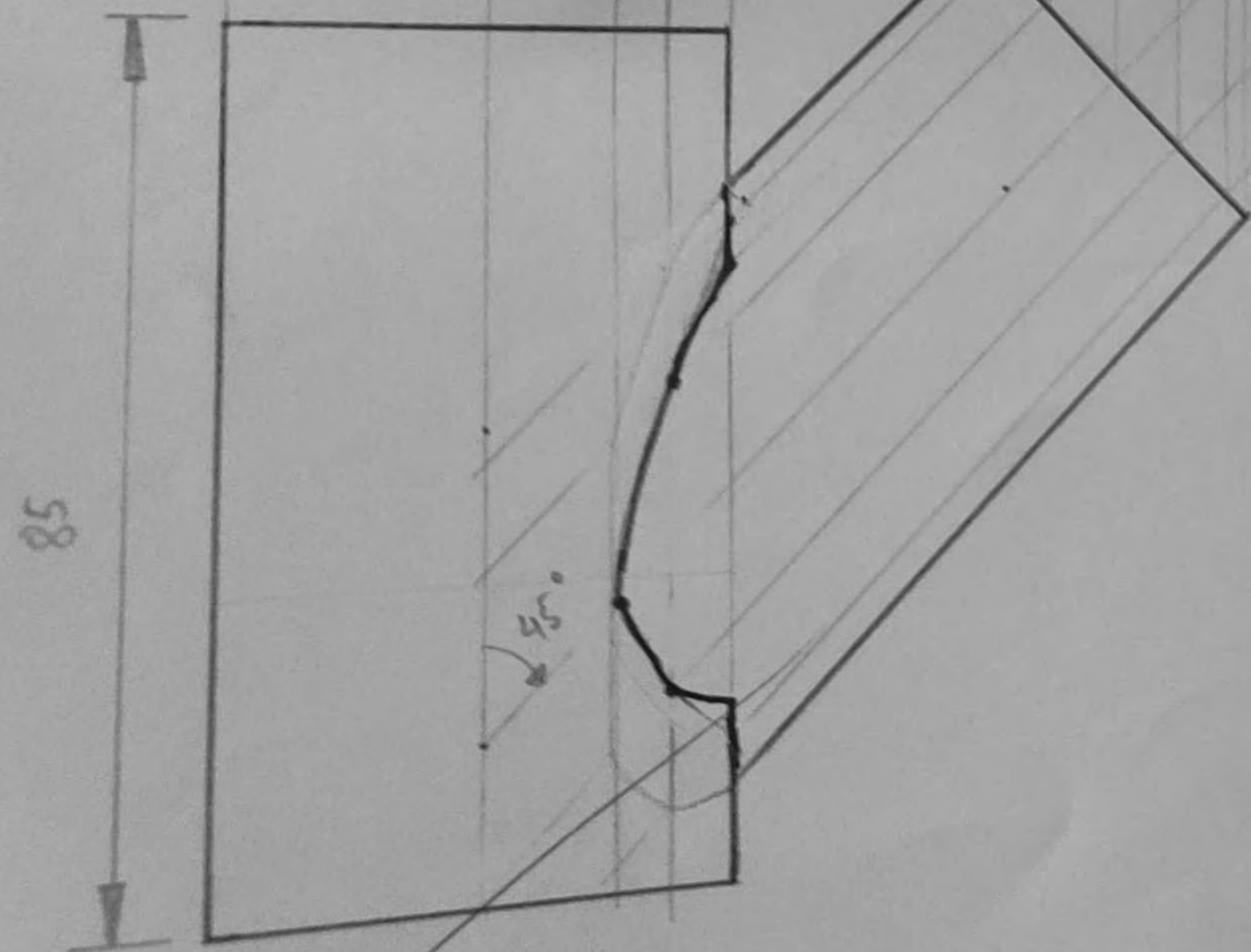
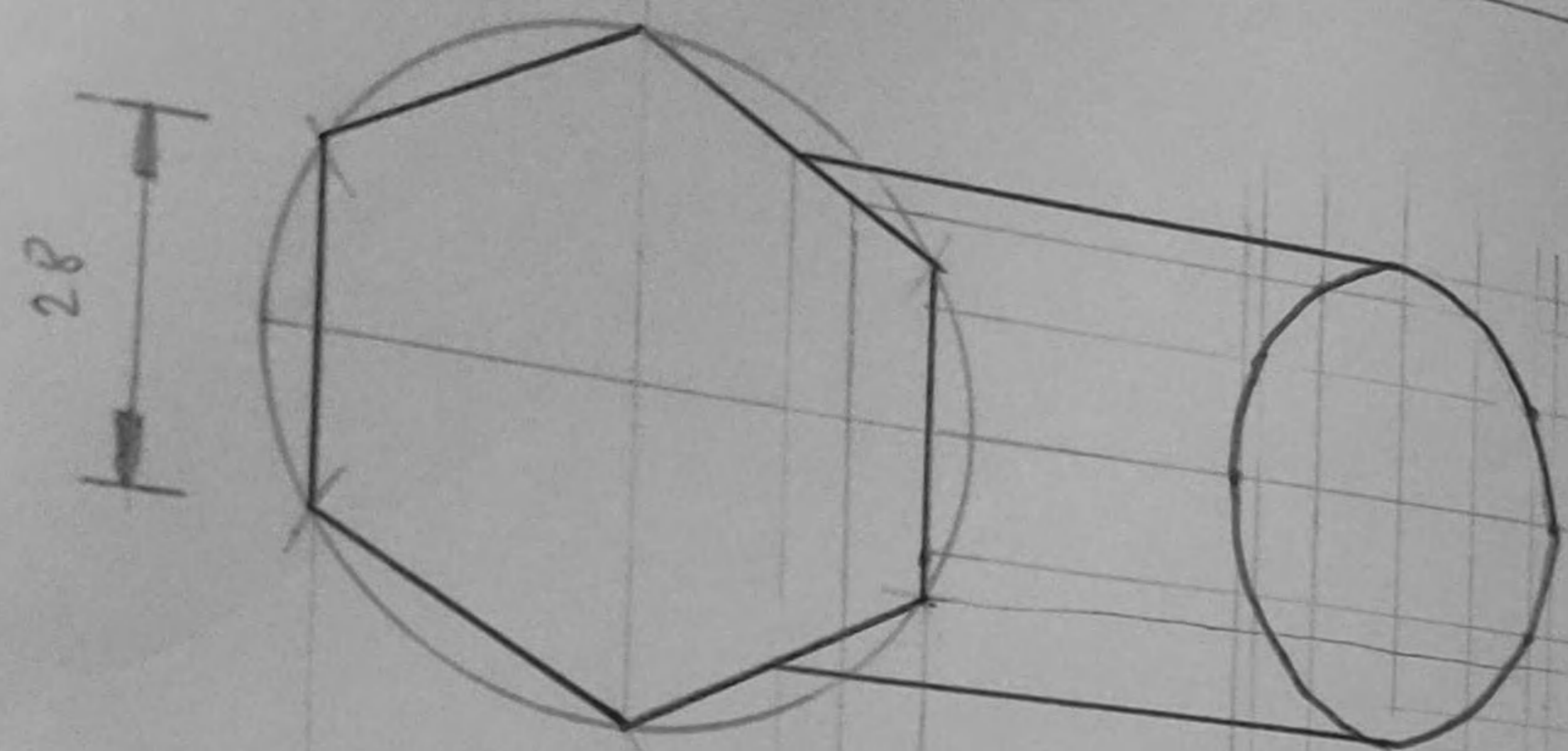

Fig 10.5

S.N.	DESCRIPTION	QTY	MATERIAL	REMARK
DRAWN BY	KRISHNA MURARI ARYAL			
ROLL NO	009			NCE
CHKD BY				
TITLE				
SCALE	1:1			
DATE	20/5/2026			
	METRIC SYSTEM			
		DRG SHEET NO:-	10	

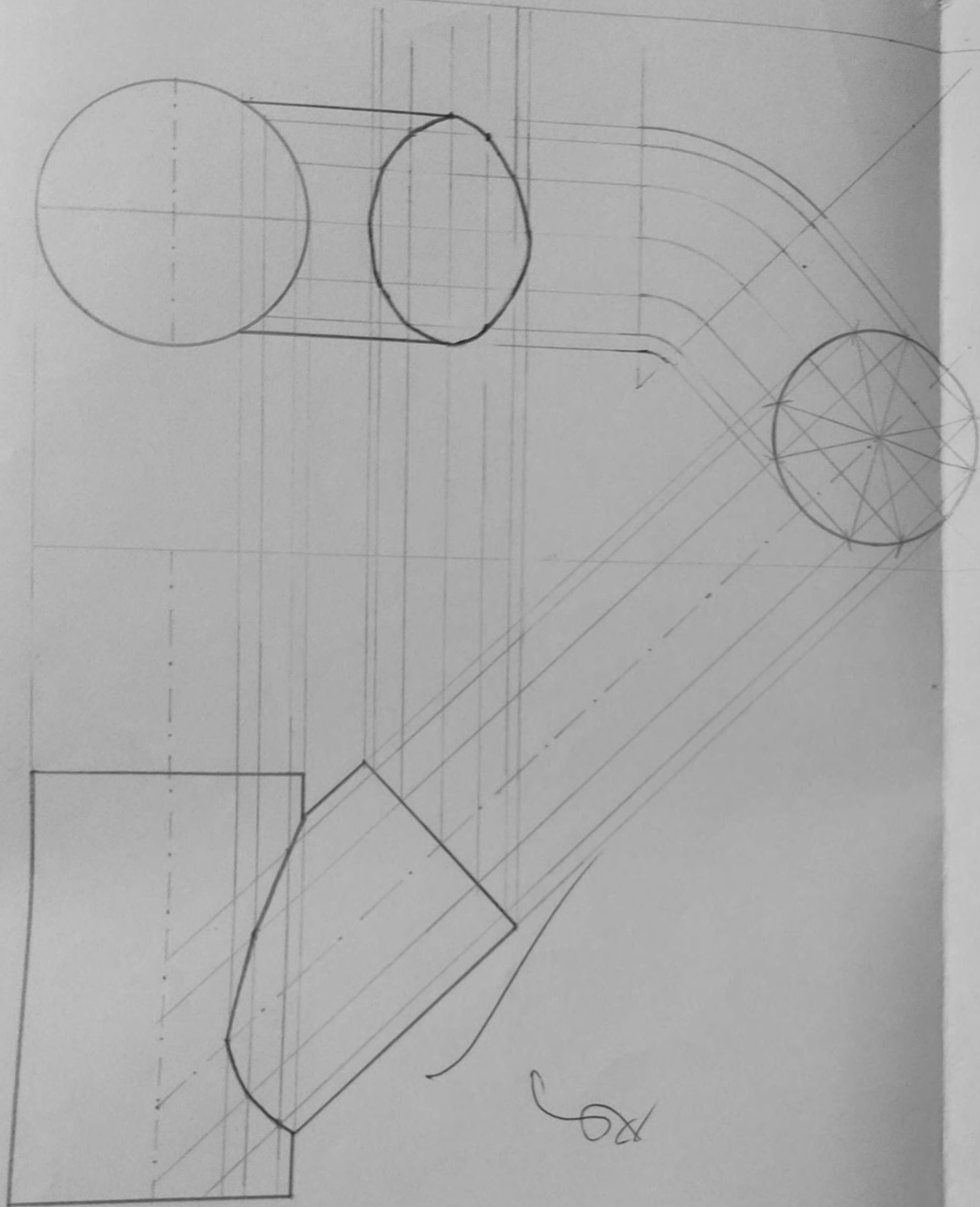

Fig 10.6

PO

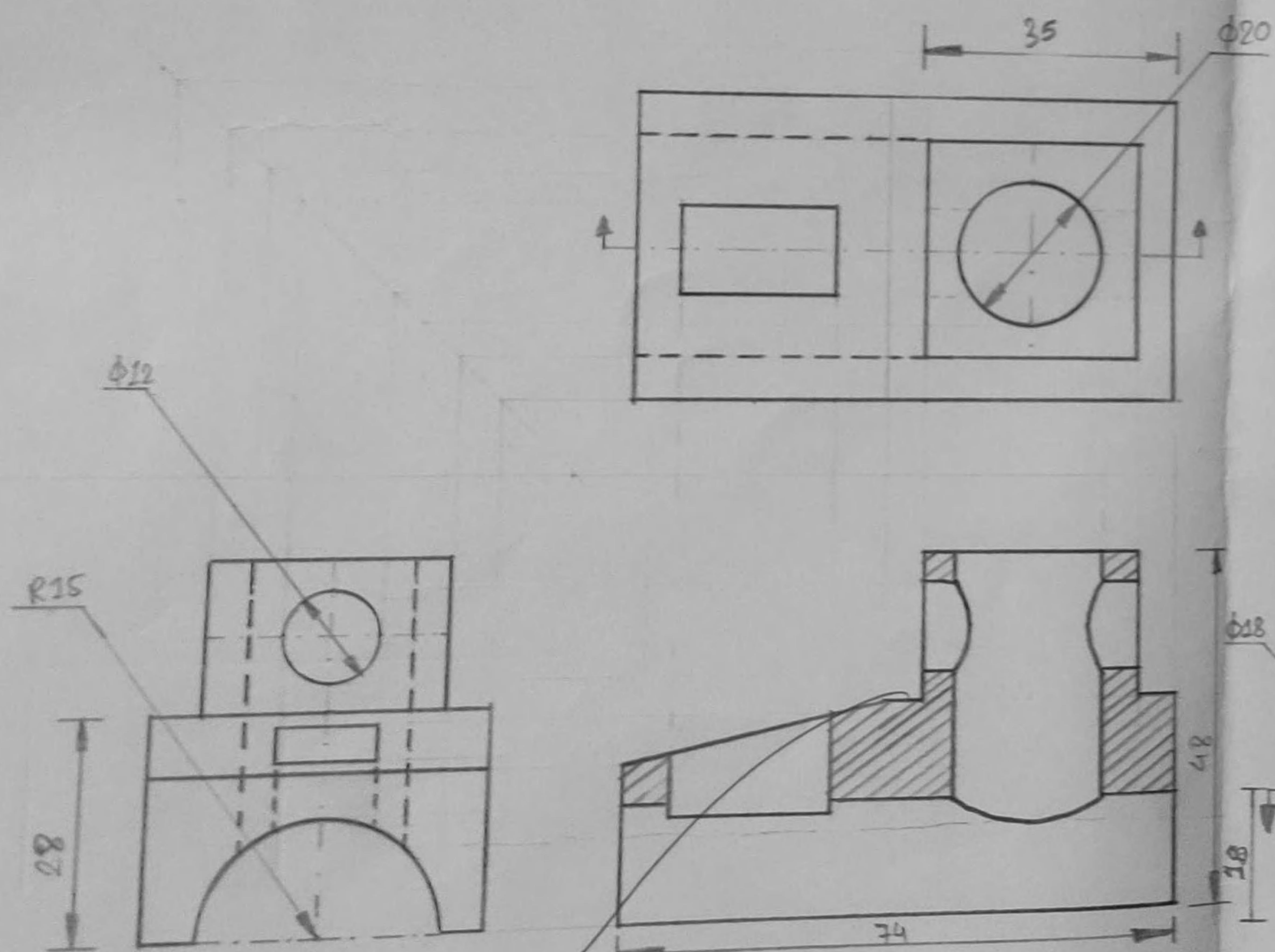

fig 11.9

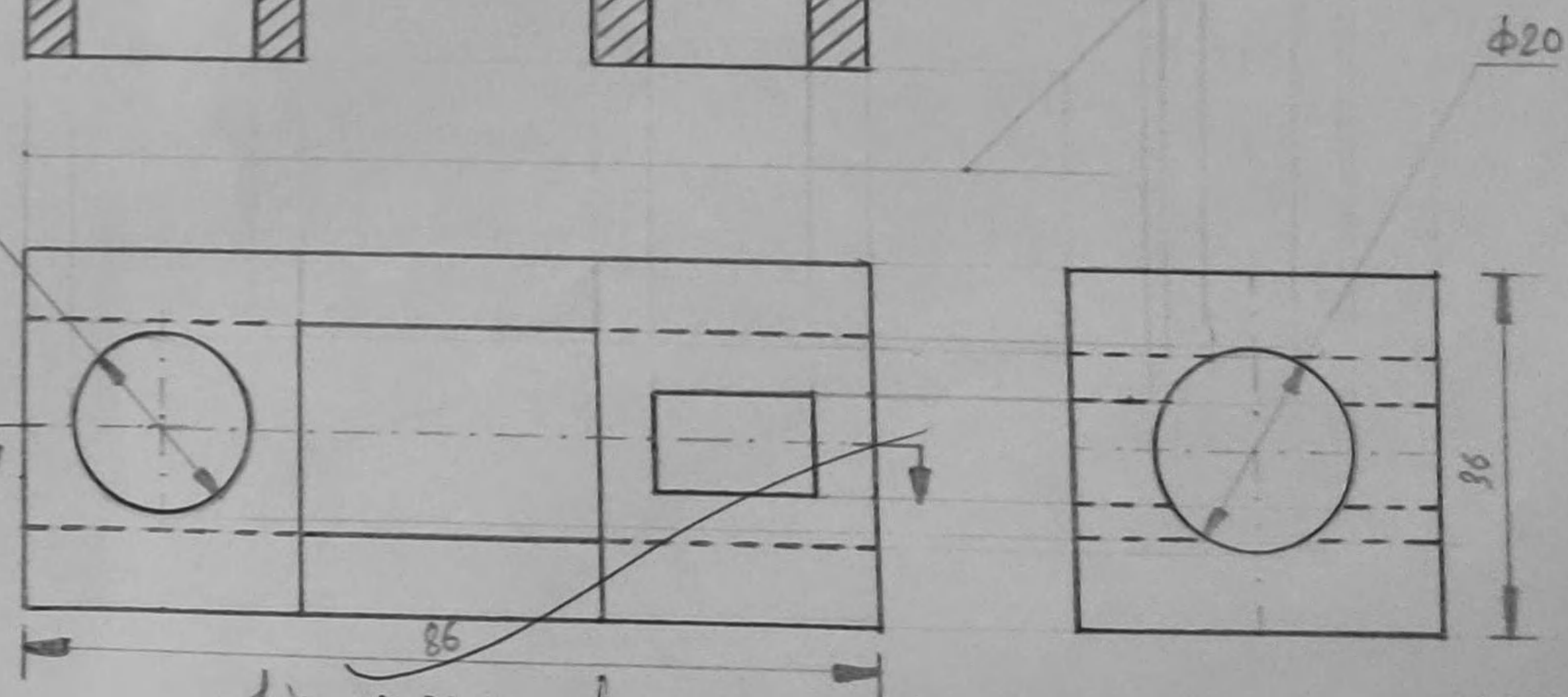
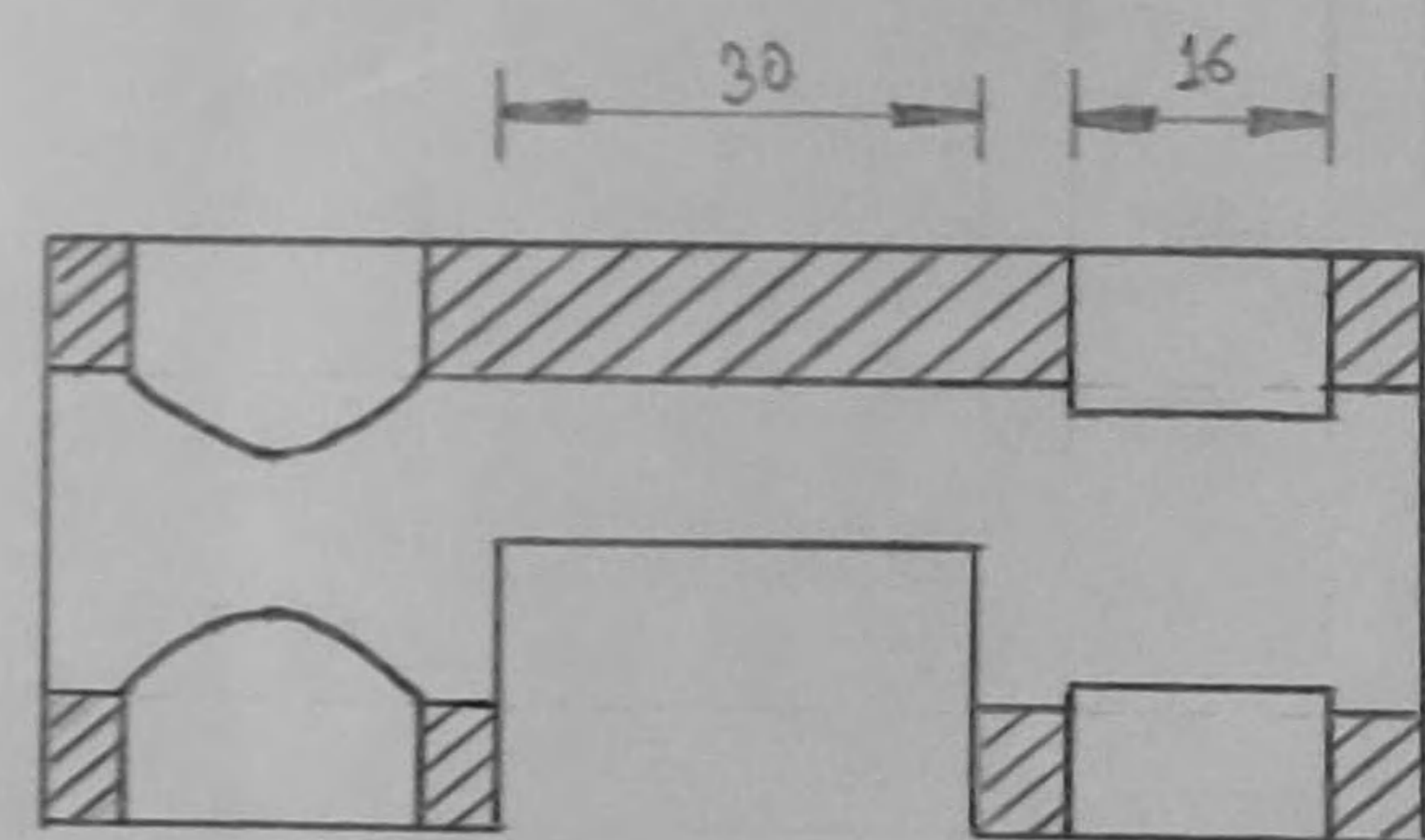

fig 11.2(a)

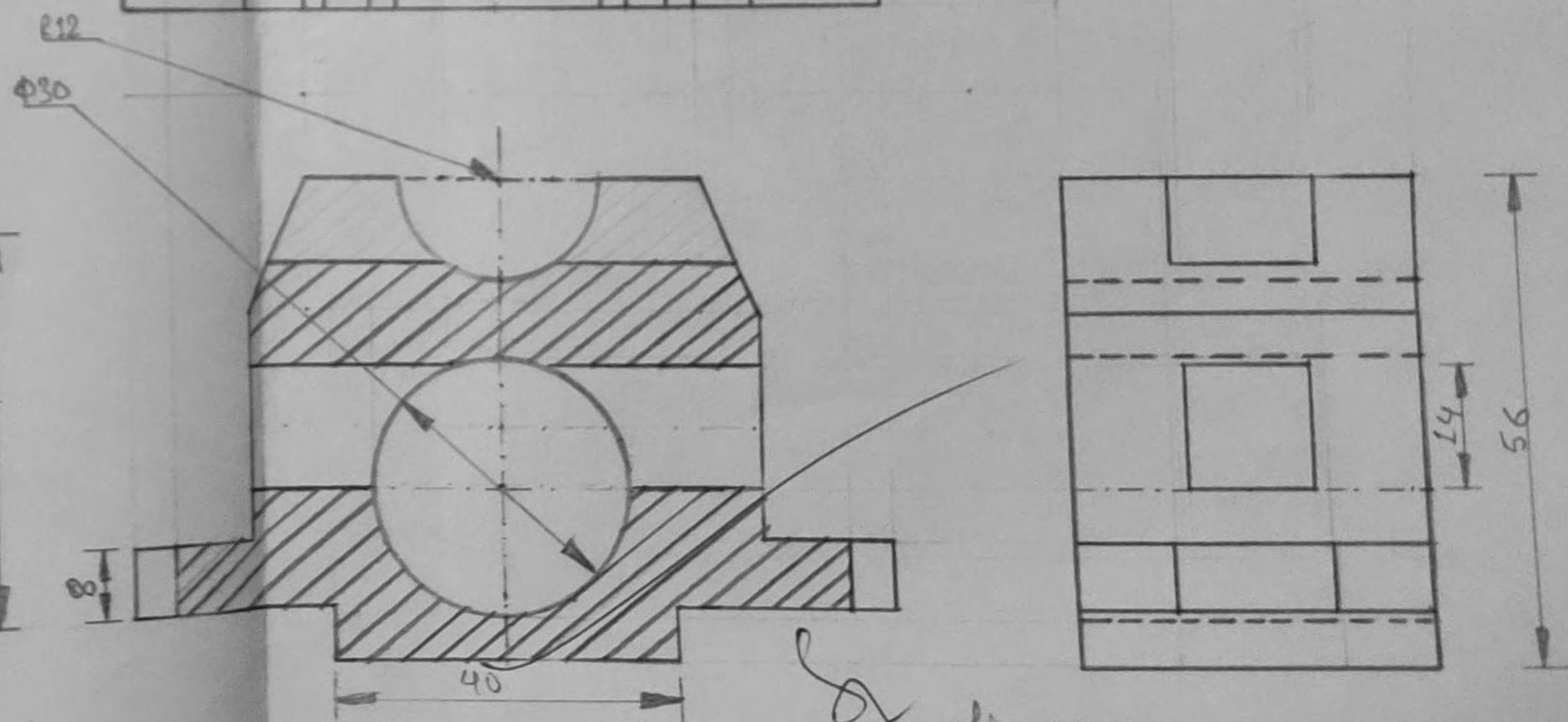
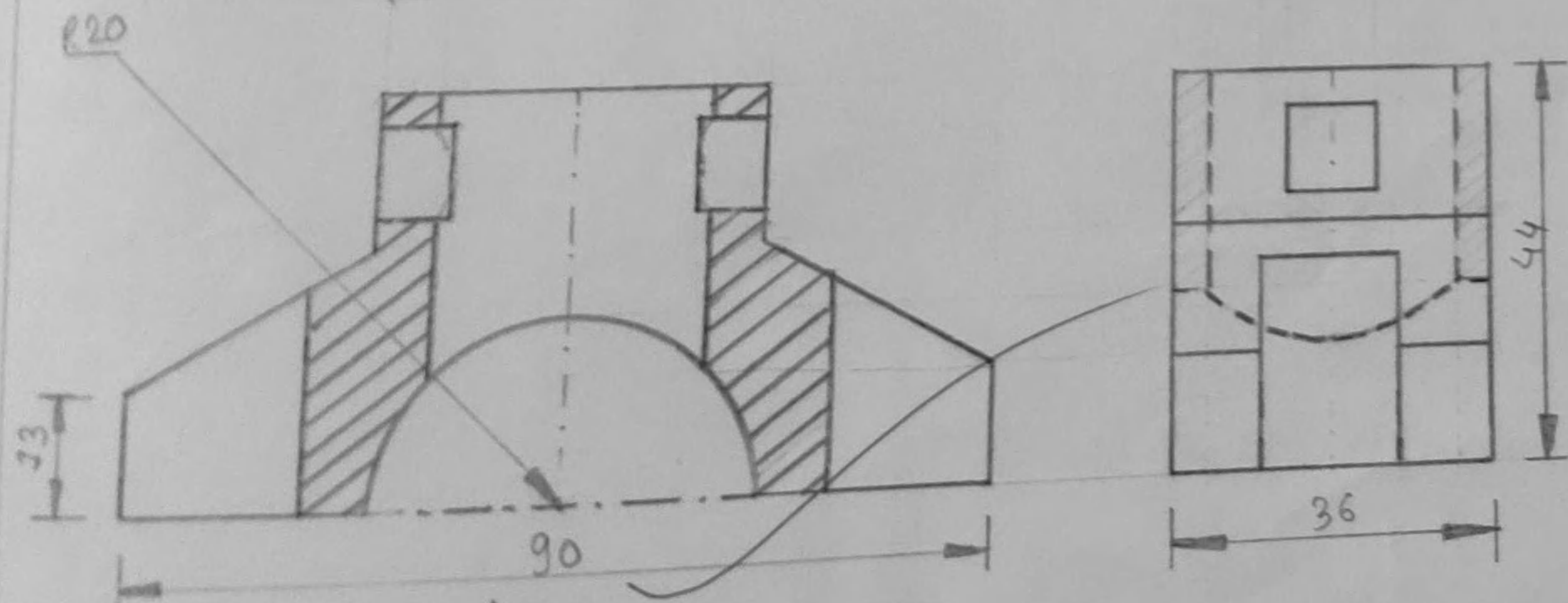
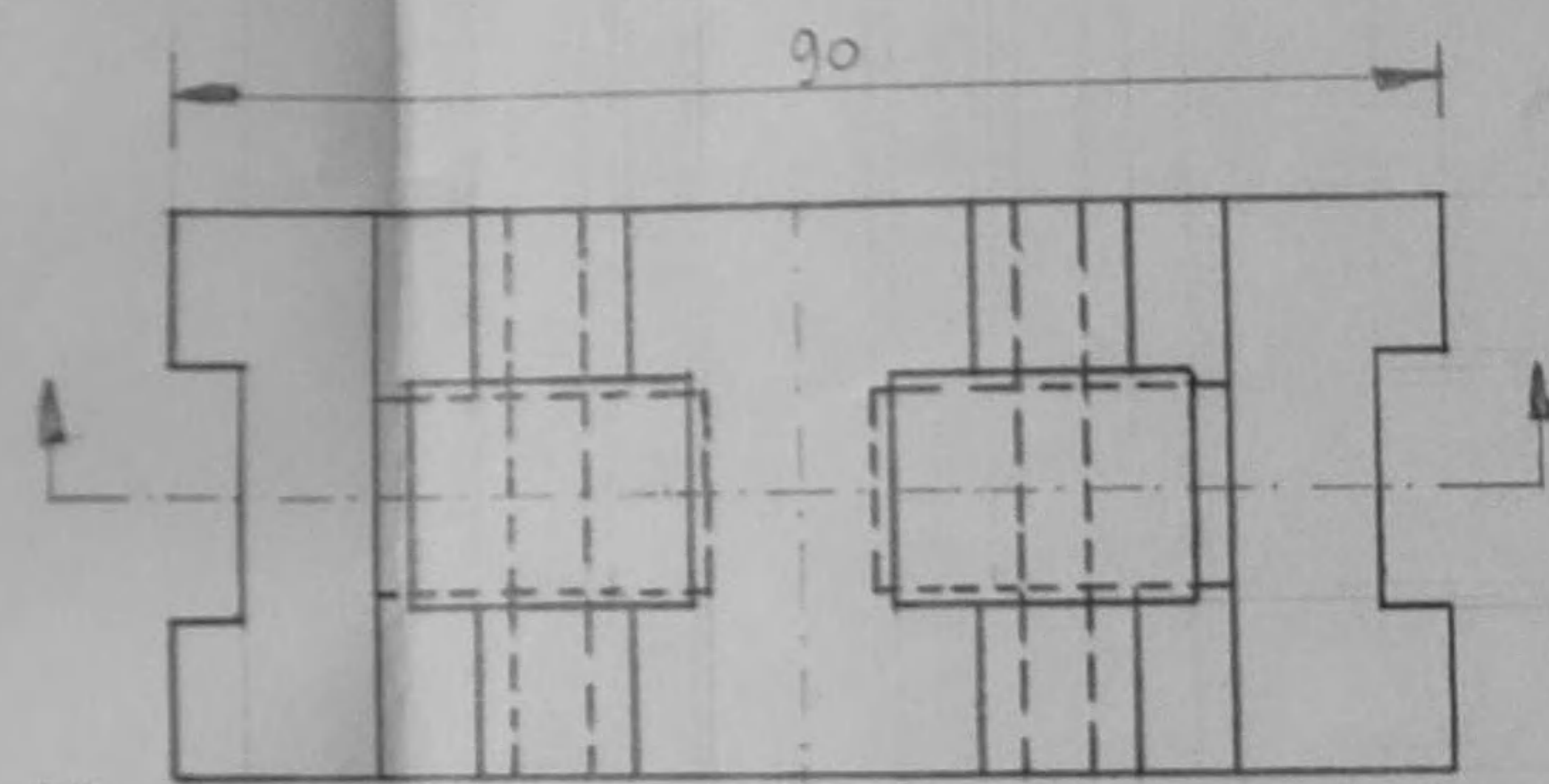
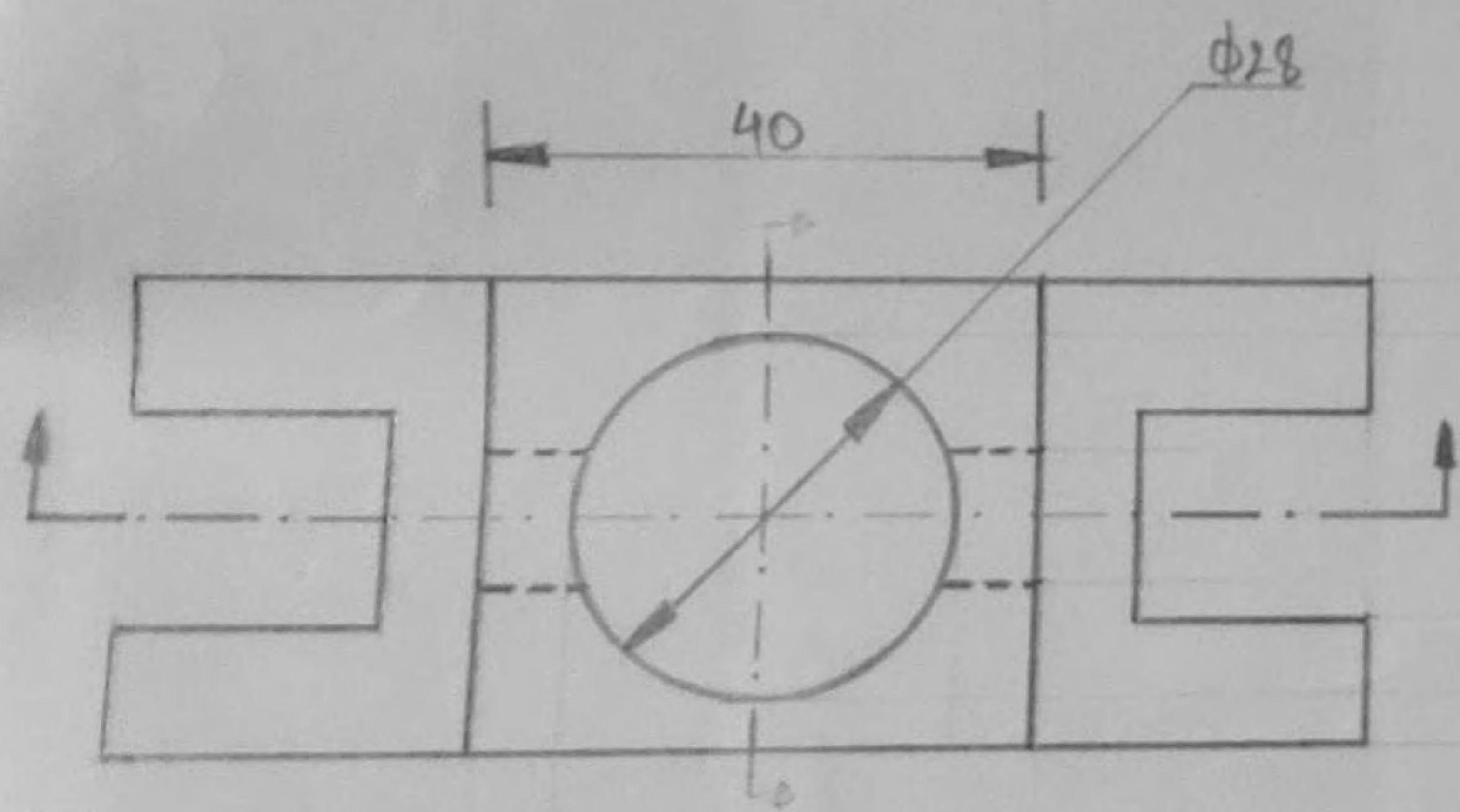

fig 11.b

fig 11.c

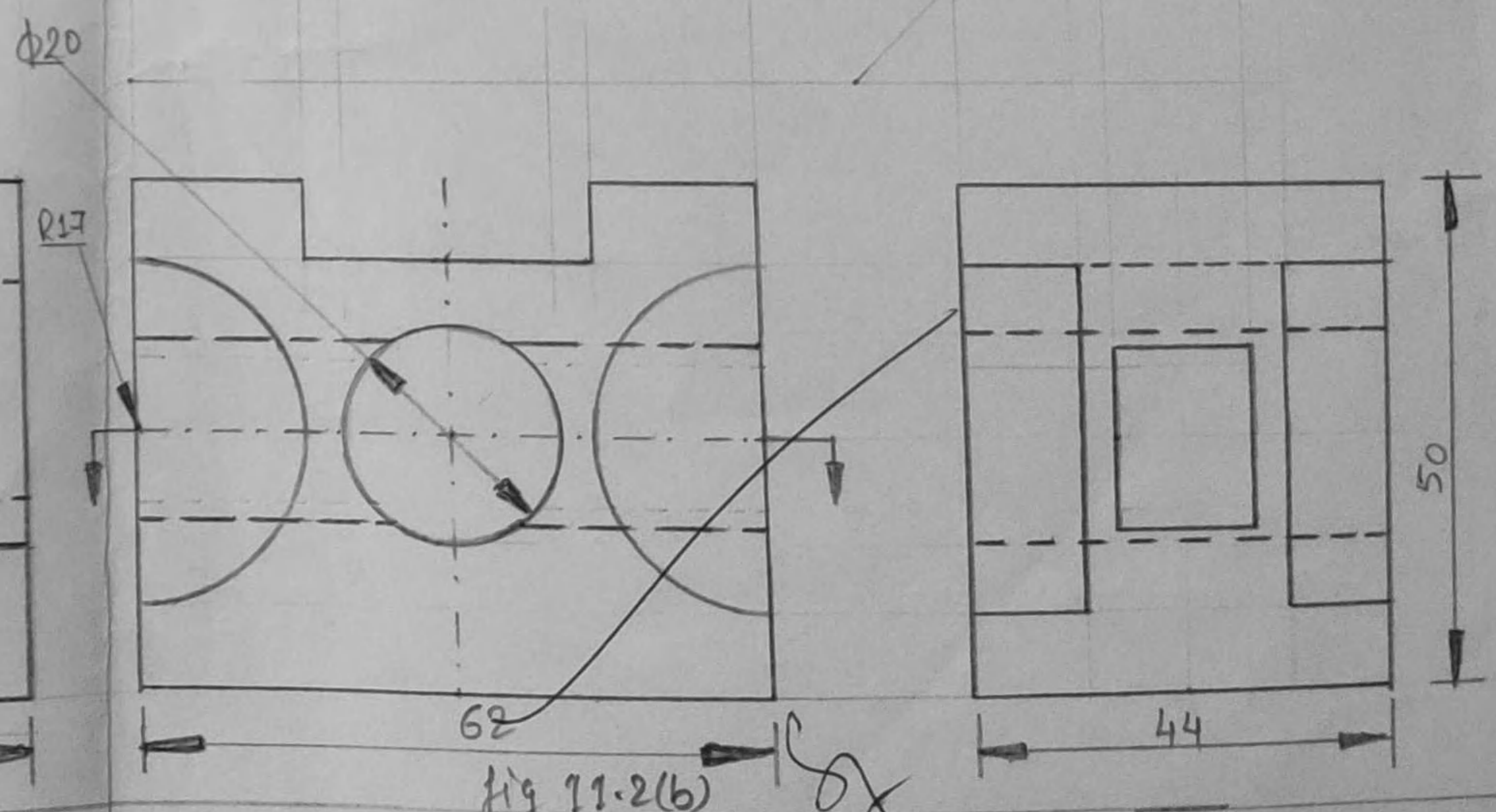
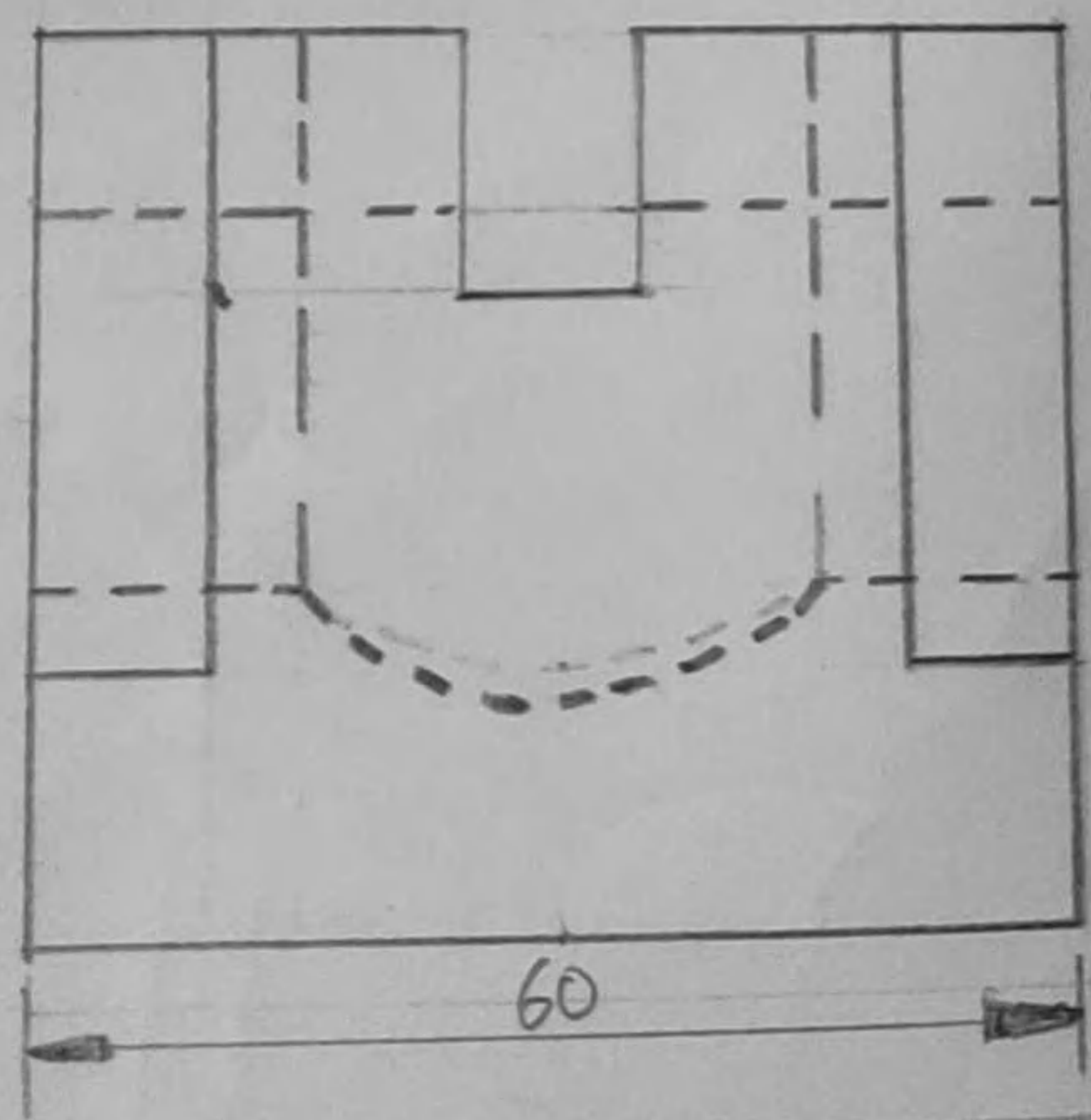
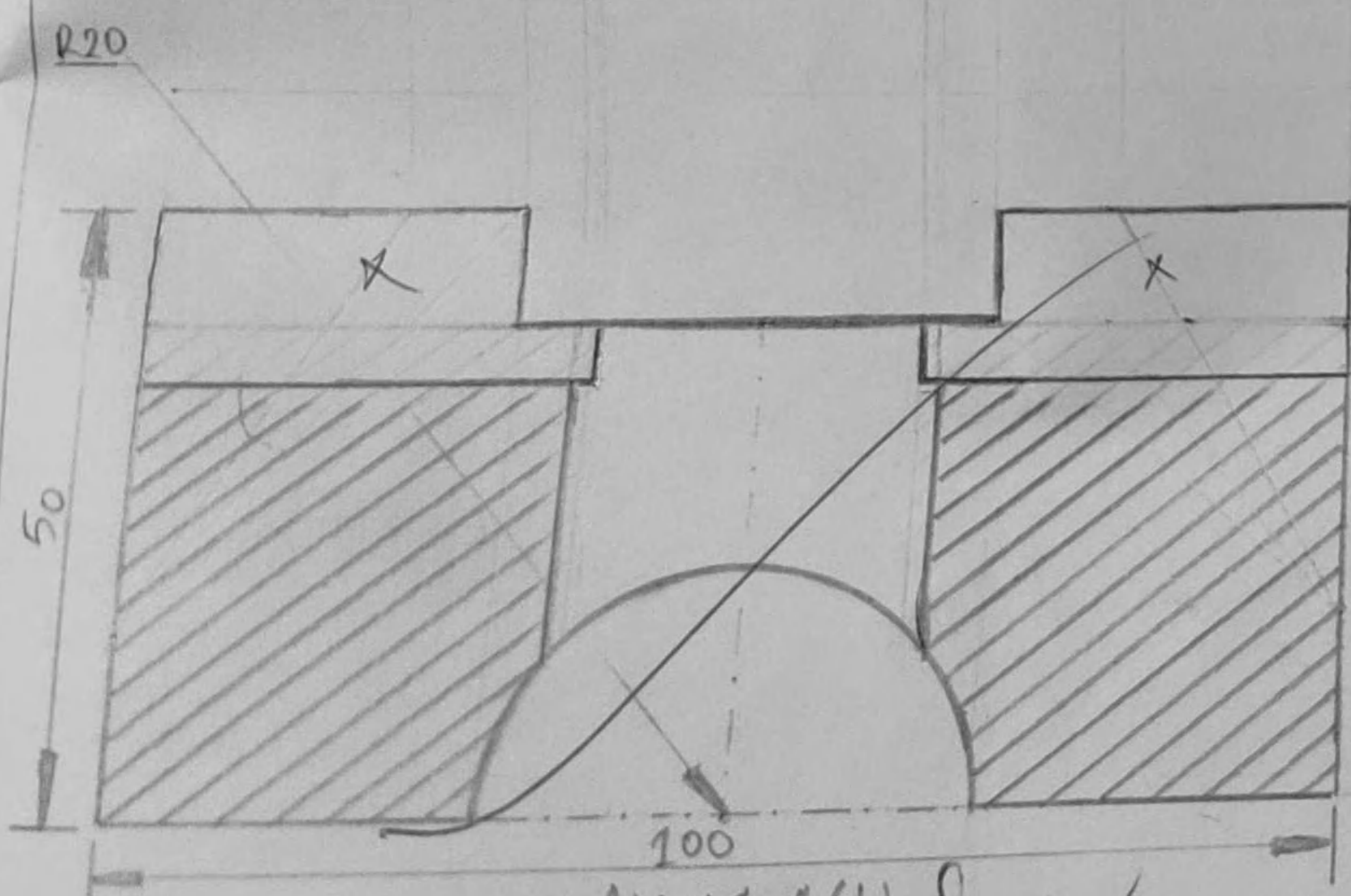
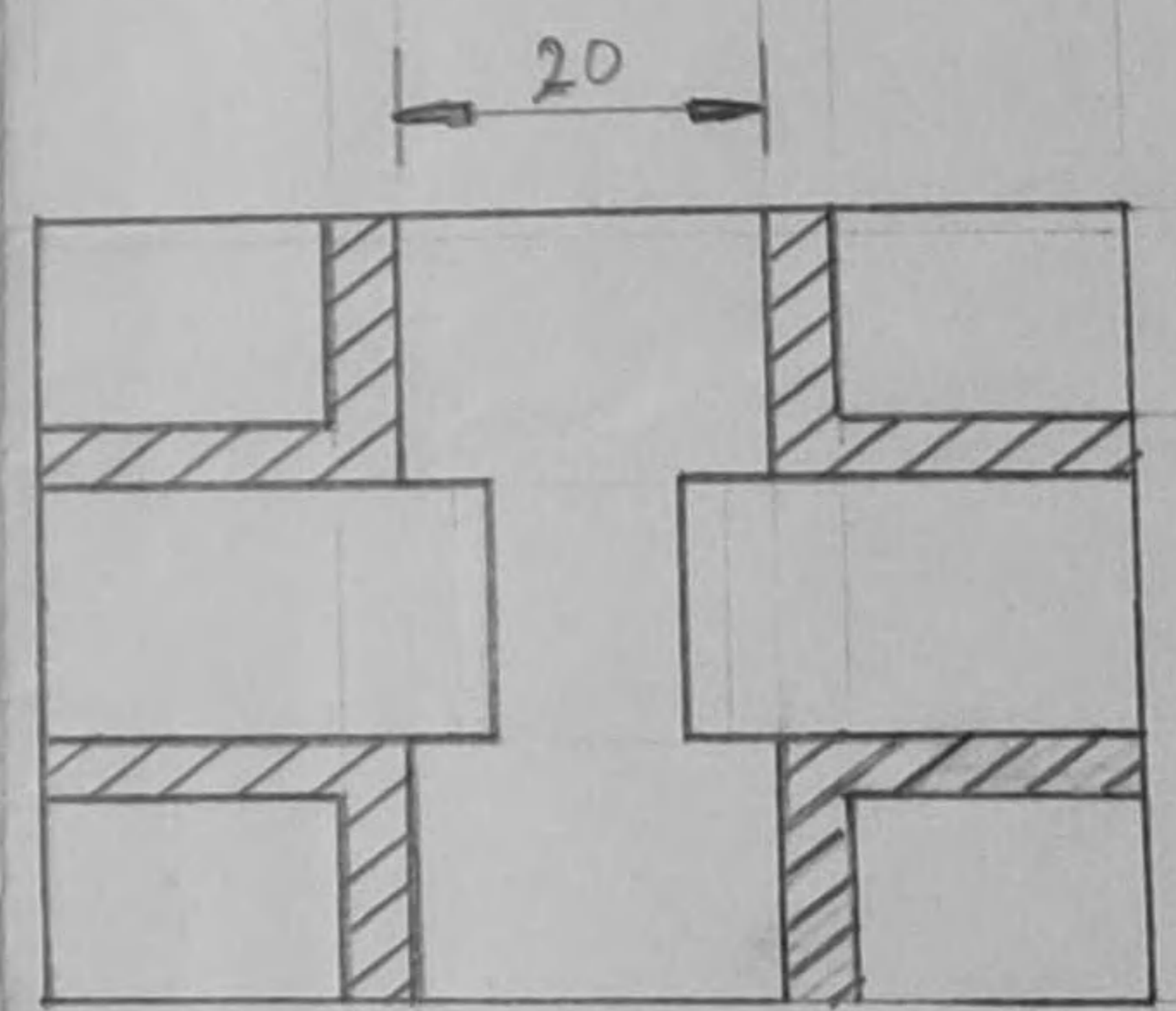
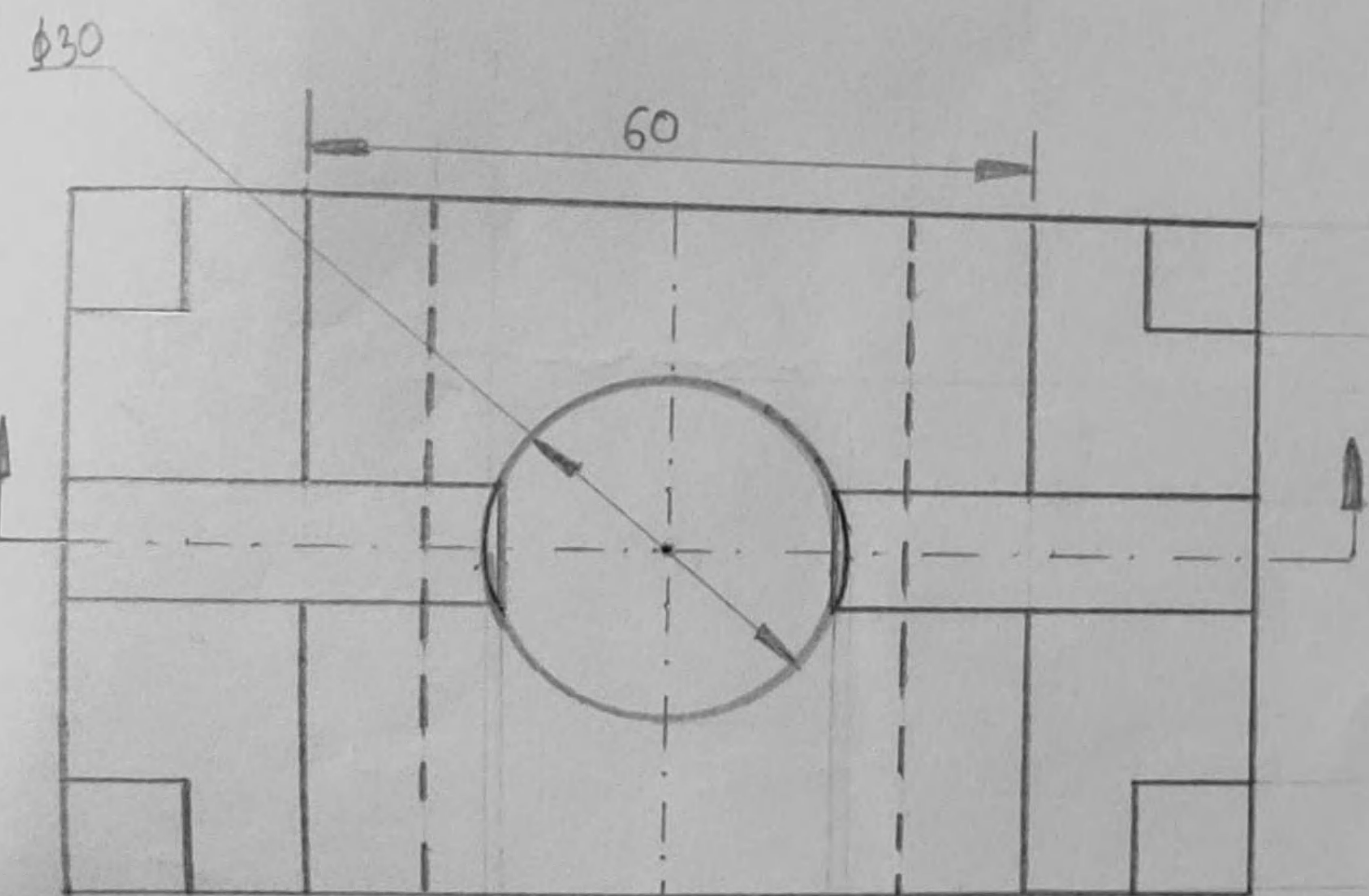

fig 11.1(a) *OK*

fig 11.2(b) *OK*